

J U N E 2 0 2 0

REPORT TO THE CONGRESS

Medicare and the
Health Care
Delivery System

MEDpAC Medicare
Payment Advisory
Commission

MEDPAC

Medicare
Payment Advisory
Commission

The Medicare Payment Advisory Commission (MedPAC) is an independent congressional agency established by the Balanced Budget Act of 1997 (P.L. 105–33) to advise the U.S. Congress on issues affecting the Medicare program. In addition to advising the Congress on payments to health plans participating in the Medicare Advantage program and providers in Medicare’s traditional fee-for-service program, MedPAC is also tasked with analyzing access to care, quality of care, and other issues affecting Medicare.

The Commission’s 17 members bring diverse expertise in the financing and delivery of health care services. Commissioners are appointed to three-year terms (subject to renewal) by the Comptroller General and serve part time. Appointments are staggered; the terms of five or six Commissioners expire each year. The Commission is supported by an executive director and a staff of analysts, who typically have backgrounds in economics, health policy, and public health.

MedPAC meets publicly to discuss policy issues and formulate its recommendations to the Congress. In the course of these meetings, Commissioners consider the results of staff research, presentations by policy experts, and comments from interested parties. (Meeting transcripts are available at www.medpac.gov.) Commission members and staff also seek input on Medicare issues through frequent meetings with individuals interested in the program, including staff from congressional committees and the Centers for Medicare & Medicaid Services (CMS), health care researchers, health care providers, and beneficiary advocates.

Two reports—issued in March and June each year—are the primary outlets for Commission recommendations. In addition to annual reports and occasional reports on subjects requested by the Congress, MedPAC advises the Congress through other avenues, including comments on reports and proposed regulations issued by the Secretary of the Department of Health and Human Services, testimony, and briefings for congressional staff.

REPORT TO THE CONGRESS

Medicare and the
Health Care
Delivery System

MEDPAC Medicare
Payment Advisory
Commission

425 I Street, NW • Suite 701 • Washington, DC 20001
(202) 220-3700 • Fax: (202) 220-3759 • www.medpac.gov



425 I Street, NW • Suite 701
Washington, DC 20001
202-220-3700 • Fax: 202-220-3759
www.medpac.gov

Francis J. Crosson, M.D., Chairman
Paul B. Ginsburg, Ph.D., Vice Chairman
James E. Mathews, Ph.D., Executive Director

June 15, 2020

The Honorable Michael R. Pence
President of the Senate
U.S. Capitol
Washington, DC 20510

The Honorable Nancy Pelosi
Speaker of the House
U.S. House of Representatives
U.S. Capitol
Room H-232
Washington, DC 20515

Dear Mr. President and Madam Speaker:

I am pleased to submit the Medicare Payment Advisory Commission's June 2020 *Report to the Congress: Medicare and the Health Care Delivery System*. This report fulfills the Commission's legislative mandate to evaluate Medicare payment issues and to make recommendations to the Congress.

In the seven chapters in this report, we consider:

- realizing the promise of value-based payment in Medicare, an agenda for change.
- challenges in maintaining and increasing savings from accountable care organizations.
- replacing the Medicare Advantage quality bonus program.
- the impact of changes in the 21st Century Cures Act to risk adjustment for Medicare Advantage enrollees, a mandated report.
- realigning incentives in Medicare Part D.
- separately payable drugs in the hospital outpatient prospective payment system.
- improving Medicare's end-stage renal disease prospective payment system.

In particular, I wish to draw your attention to Chapter 1, which is the result of a year-long Commission discussion about the future of the Medicare program. The Commission believes that unless substantial changes are made to the way Medicare pays for services and to how beneficiary care is organized and delivered, the cost of the Medicare program will remain on an unsustainable trajectory. The Commission

asserts that the use of fee-for-service payment for Medicare services should be replaced, over time and to the degree feasible, by payment to accountable systems of care that have incentives to:

- provide preventive services and early disease detection.
- improve the quality and beneficiary experience of care.
- avoid delivering unnecessary or inappropriate services.
- control the costs of providing necessary services in the most appropriate care setting.
- deliver chronic care services through care coordination among providers.
- coordinate both the medical and nonmedical needs of beneficiaries.
- enhance the use of technologies that improve quality and reduce program costs.

Under an improved Medicare program, most beneficiaries would be able to opt to receive their care through accountable entities. Medicare could design incentives that encourage beneficiaries to choose one of these entities and give providers incentives to participate in them.

The Commission well understands the magnitude of effort inherent in making such changes. That said, improvements in the Medicare Advantage program, in the various accountable care organization programs, and in other payment or delivery system innovations currently in place can be starting points for this work. In addition, serious attention must be given to new innovations, for example, changing how hospitals are paid and giving providers incentives to manage the cost of medications. The Commission believes that the culmination of the changes we have outlined will provide the Congress and the American people with the opportunity to better predict and manage the long-term cost and quality of the Medicare program.

Although this report sets out a vision for the direction for Medicare payment in the future and makes recommendations for needed changes in today's Medicare payment systems, the Commission realizes that the Congress and CMS are currently coping with the profound challenges facing Medicare and the entire health care system as it contends with the reality of the coronavirus pandemic. The health care system and, most importantly, the individuals caring for the victims of the pandemic need our support and the resources to do their jobs. We will provide whatever advice and assistance that we can at this time to the Congress and CMS as the Medicare program adapts to today's realities. In the future, we will attempt to take lessons learned from today's experience into our assessments of Medicare's payment systems as we help the Congress grapple with the difficult task of controlling the growth of Medicare spending while preserving beneficiaries' access to high-quality care and providing sufficient payment for efficient providers.

Sincerely,

A handwritten signature in black ink that reads "Francis J. Crosson M.D." The signature is written in a cursive, flowing style.

Francis J. Crosson, M.D.

Enclosure

Acknowledgments

This report was prepared with the assistance of many people. Their support was key as the Commission considered policy issues and worked toward consensus on its recommendations.

Despite a heavy workload, staff members of the Centers for Medicare & Medicaid Services and the Department of Health and Human Services were particularly helpful during preparation of the report. We thank Michelle Cruse, Liz Goldstein, Jennifer Lazio, Blake Pelzer, John Pilotte, Cheri Rice, Abby Ryan, Tiffany Swygert, and Pete Welch.

The Commission also received valuable insights and assistance from others in government, industry, and the research community who generously offered their time and knowledge. They include Michael Bagel, Colin Baker, Greg Berger, Ashley Czin, Richard Fuller, Jane Galvin,

Stuart Hammond, Rick Kronick, Kathy Lester, Chris Lovell, Rob Mechanic, David Muhlestein, Cori Uccello, and Rebecca Yip.

Once again, the programmers and staff at Social & Scientific Systems, a DLH Holdings Corp. Company, provided highly capable assistance to Commission staff. In particular, we appreciate the hard work of Michael Brown, Po-Lun Chou, John Crouch, Daksha Damera, Darya Leyzarovich, Sravani Mallela, Sane Maphunghong, Shelley Mullins, Lorena Ortiz, Cindy Saiontz-Martinez, Allen Selwyn, and Susan Tian.

Finally, the Commission wishes to thank Hannah Fein, Mary Gawlik, and Melissa Lux for their help in editing and producing this report. ■

Table of contents

Acknowledgments	v
Executive summary	xi
Chapters	
1 Realizing the promise of value-based payment in Medicare: An agenda for change	3
Introduction	3
Medicare Advantage and accountable care organizations could provide a foundation for expanding value-based payment	4
The problem of fee-for-service payment	5
A need for change	6
Future vision for the Medicare program	7
2 Challenges in maintaining and increasing savings from accountable care organizations	13
Background	17
Proposed strategies to increase ACO savings	19
Potential for unwarranted shared savings from patient selection	25
Use of NPI for assignment would improve benchmark validity and reduce unintended incentives	37
3 Replacing the Medicare Advantage quality bonus program	47
Quality in Medicare Advantage is difficult to evaluate and the quality bonus program is flawed	51
Design of the new MA–VIP addresses flaws in the current MA quality bonus payment system	55
Illustrative scoring and payment adjustments under the MA–VIP model	70
Replacing the Medicare Advantage quality bonus program with a new value incentive program	86
4 Mandated report: Impact of changes in the 21st Century Cures Act to risk adjustment for Medicare Advantage enrollees	95
Background on Medicare Advantage payments and risk adjustment	99
Changes required by the 21st Century Cures Act	100
Impacts of changes to CMS’s risk adjustment model for Medicare Advantage	101
Summary	114
5 Realigning incentives in Medicare Part D	119
Background	123
Restructuring Part D to restore incentives to manage spending	129
Other modifications to Part D associated with a restructured benefit	141
Recommendations for a restructured Part D benefit	151
6 Separately payable drugs in the hospital outpatient prospective payment system	163
Background	167
Identifying drugs that should be separately payable in the OPSS	169
Considering the criteria used in various Medicare payment systems for the OPSS	172
How long should a drug be separately payable?	174
Summary	175

7 Improving Medicare’s end-stage renal disease prospective payment system 181

 Background 185

 Current payment for new ESRD drugs under the ESRD PPS 186

 Eliminating the TDAPA for new drugs in an existing ESRD functional category 188

 Current payment for low-volume and rural dialysis facilities 190

 Improving the adequacy of payments for low-volume and isolated facilities 195

Appendix A Commissioners’ voting on recommendations 211

Acronyms 217

More about MedPAC

Commission members 221

Commissioners’ biographies 223

Commission staff 227

Executive summary

Executive summary

As part of its mandate from the Congress, each June the Commission reports on refinements to Medicare payment systems and issues affecting the Medicare program, including broader changes in health care delivery and the market for health care services. In the seven chapters of this report, we consider:

- **Realizing the promise of value-based payment in Medicare: An agenda for change.** The Commission outlines a multiyear effort to lay out a strategic direction for Medicare payment policy and delivery system design that broaden the use of value-based payment.
- **Challenges in maintaining and increasing savings from accountable care organizations (ACOs).** The Commission evaluates past savings, examines strategies to increase savings, and recommends a technical change that will reduce the risk that program vulnerabilities might result in unwarranted shared savings payments to ACOs.
- **Replacing the Medicare Advantage quality bonus program.** Medicare’s quality bonus program (QBP) for assessing and rewarding quality performance in the Medicare Advantage (MA) program is flawed and not consistent with the Commission’s principles for quality incentive programs. In the June 2019 report to the Congress, we introduced an alternative MA value incentive program (MA–VIP). In this report, the Commission recommends that the Congress replace the QBP with an MA–VIP that includes five key design elements.
- **Mandated report: Impact of changes in the 21st Century Cures Act to risk adjustment for Medicare Advantage enrollees.** The 21st Century Cures Act of 2016 directs the Secretary to make several changes to the CMS hierarchical condition category (CMS–HCC) model, which CMS uses to calculate the enrollee risk scores that adjust MA capitated payments. We assess how each of those changes affects the ability of the CMS–HCC model to predict costs for various Medicare beneficiary populations.
- **Realigning incentives in Medicare Part D.** The Commission proposes a package of recommendations to reform Part D and realign plan and manufacturer

incentives. The recommendations will limit enrollees’ out-of-pocket spending; help restore the role of risk-based, capitated payments; and eliminate features of the current program that distort market incentives. These changes will better align the incentives in Part D with the interests of the Medicare program and its beneficiaries.

- **Separately payable drugs in the hospital outpatient prospective payment system.** Medicare payment systems that bundle multiple services into one payment, such as the outpatient prospective payment system (OPPS), create incentives for providers to be judicious about the cost inputs of the services they provide. Paying for items outside the bundle—such as separately payable drugs—should be done only under certain circumstances, such as when a new drug exhibits clinical superiority over an existing drug. In future work, we will determine other criteria for identifying which drugs should be separately payable.
- **Improving Medicare’s end-stage renal disease prospective payment system.** The Commission recommends (1) eliminating the payment adjustment for certain new drugs and (2) replacing the separate low-volume and rural payment adjustments with a single payment adjustment—a low-volume and isolated payment adjustment—that will protect isolated, low-volume dialysis facilities that are critical to ensure beneficiary access.

Although this report sets out a vision for the direction of Medicare payment systems in the future and makes specific recommendations for needed changes in today’s Medicare payment systems, the Commission realizes that the Congress and CMS are currently coping with the profound challenges facing Medicare and the entire health care system as they contend with the reality of the coronavirus pandemic. We will provide whatever advice and assistance that we can at this time to the Congress and to CMS as the Medicare program adapts to today’s realities. In the future, we will attempt to take lessons learned from today’s experience into our assessments of Medicare’s payment systems as we help the Congress grapple with the difficult task of controlling the growth of Medicare spending while preserving beneficiaries’ access to high-quality care and providing sufficient payment for efficient providers.

Realizing the promise of value-based payment in Medicare: An agenda for change

In Chapter 1, the Commission outlines a multiyear effort to establish a strategic direction for Medicare payment policy and delivery system design that could be implemented by the Congress and CMS. This work will be aimed at identifying changes that broaden the use of value-based payment (which characterizes methods of paying for health care services that provide stronger incentives than fee-for-service to control overall costs while maintaining or improving quality) by encouraging more providers to organize into “accountable entities.” Such entities would be capable of receiving payments from Medicare and accepting accountability for both the cost and the overall health of a group of beneficiaries. Medicare Advantage and accountable care organizations could serve as vehicles to broaden the use of value-based payment, but both programs need to be improved to realize that potential. This work will be guided by the same fundamental principles that serve as the foundation for all of our policy development: ensuring that beneficiaries have access to high-quality care in an appropriate setting, paying providers equitably and giving them incentives to supply efficient and appropriate care, and assuring the best use of the taxpayer dollars that finance most of Medicare’s spending.

The Commission contends that policymakers will need new approaches to both how Medicare pays providers and how services are organized and delivered to address the currently unsustainable trends in Medicare spending. In 2018, Medicare accounted for 3.6 percent of the country’s gross domestic product, and that figure will grow to 4.7 percent by 2027. As the population ages, the number of workers per Medicare beneficiary is expected to decline—from 3.0 in 2019 to a projected 2.5 in 2029—making the financing of the program more challenging. For example, the program’s Part A trust fund is projected to exhaust its reserves in 2026, which will force Medicare to sharply reduce payment rates for hospitals and other Part A providers unless policymakers take some other action. These trends could result in dramatic changes to the Medicare program and its financing if deliberate changes are not made to how Medicare pays for care and to how care is organized and delivered.

Challenges in maintaining and increasing savings from accountable care organizations

CMS has made it a priority to move more Medicare beneficiaries into alternative payment models in which providers are responsible for the cost and quality of care. One such model is the accountable care organization (ACO). ACOs are now responsible for 23 percent of Medicare beneficiaries with both Part A and Part B coverage. Given the rapid growth in ACOs, it is important to evaluate whether they are generating savings for the Medicare program and thus helping make the program more sustainable. In Chapter 2, the Commission evaluates past savings, examines strategies to increase savings, and recommends a technical change that will reduce the risk that program vulnerabilities might result in unwarranted shared savings payments to ACOs that exceed the rate of savings achieved to this point.

To date, ACOs have generated modest savings, with most evaluations estimating 1 percent to 2 percent reductions in spending from existing ACO models. Some have expressed a concern that the ability of Medicare ACOs to achieve savings has been limited because key constituencies are not sufficiently engaged with ACOs and have incentives that run counter to those of ACOs. CMS and others have expressed an interest in trying to enhance ACOs’ ability to generate savings by creating greater engagement with beneficiaries and specialists, reducing hospital incentives to increase services, and aligning incentives for ACOs and prescription drug use under Part D. However, all of these strategies involve implementation challenges.

Because Medicare savings from Medicare Shared Savings Program ACOs have been relatively small thus far (although still greater than most care coordination demonstrations), there is a risk that those savings could be eroded, or even completely offset, by unwarranted shared savings payments. Patient selection in ACOs could result in unwarranted shared savings payments, whether the selection is intentional or not. For example, if high-cost beneficiaries are disproportionately shifted out of an ACO in its performance year—while remaining in the baseline years—performance-year spending will decrease in relation to the ACO’s benchmark. This phenomenon could occur if clinicians with high-cost beneficiaries bill under a taxpayer identification number (TIN) that is not part of the ACO or if a clinician bills for patients with low spending under the ACO’s TINs and bills for patients with higher spending relative to their risk score under a non-ACO TIN.

The Commission does not believe widespread patient selection occurred in the program's early years. However, the current system allows an ACO to strategically change the composition of its TINs to increase the likelihood of receiving unwarranted shared savings relative to benchmarks, creating a vulnerability for the Medicare program.

To reduce the incentives to select patients and providers, and to reduce the potential mismatch between the clinicians considered in an ACO's baseline years and its performance years, the Commission recommends that the Secretary determine an ACO's historical baseline spending using the same national provider identifiers that are used to compute the ACO's performance-year spending. While there will always be some shared savings payments due to random variation, we should minimize opportunities for unwarranted shared savings payments due to intentional favorable provider and patient selection. Properly matching the clinicians included in an ACO's baseline and performance years will allow a more accurate assessment of an ACO's performance and reduce opportunities for unwarranted shared savings.

Replacing the Medicare Advantage quality bonus program

The Commission maintains that Medicare program payments should take into account the quality of care delivered to beneficiaries, and the Commission has formalized a set of principles for designing Medicare quality incentive programs. Medicare's quality bonus program (QBP) for assessing and rewarding quality performance in the Medicare Advantage (MA) program is not consistent with these principles, and in Chapter 3 we recommend replacing it with a new quality program: the MA value incentive program (MA-VIP).

In our June 2019 report to the Congress, we outlined multiple significant flaws in the QBP program. Those flaws must be addressed so Medicare can have confidence that the MA program encourages and appropriately rewards high quality in a manner that ensures that program dollars are wisely spent. In 2019, MA's QBP cost \$6 billion and is projected by the Congressional Budget Office to cost \$94 billion over 10 years.

The Commission recommends that the Congress replace the QBP with an MA-VIP that includes the following five key design elements:

- **Scores a small set of population-based measures.** The measure set would be tied to clinical outcomes as well as patient/enrollee experience.
- **Evaluates quality at the local market level.** Evaluating MA plan quality at the local market area level provides information about the quality of care delivered in the localities in which beneficiaries seek and receive care.
- **Uses a peer-grouping mechanism to account for differences in enrollees' social risk factors.** Comparing performance among groups of beneficiaries (e.g., fully dual-eligible beneficiaries) with similar characteristics accounts for social risk factors without masking disparities in plan performance, as would be the case if measure results themselves were adjusted by population social-risk characteristics.
- **Establishes a system for distributing rewards with no "cliff" effects.** The use of continuous performance-to-points scales allows plans that improve to earn points and avoids the cliff effect, whereby only those plans achieving a certain level of quality receive bonuses.
- **Distributes plan-financed rewards and penalties at the local market level.** The MA-VIP redistributes a pool of dollars (made up of a percentage of plan payments within the market areas) as rewards and penalties based on a plan's performance compared with the market area's other plans.

To test the proof of concept of the MA-VIP design, we modeled a prototype MA-VIP using currently available data. In stratifying results by peer groups, the MA-VIP accounts for differences in social risk factors of plan populations and allows plans the potential to earn more rewards for higher quality care provided to populations identified by the presence of certain social risk factors. Our results indicated that an MA-VIP was feasible. An illustrative withhold of 2 percent of payments yielded small penalties and rewards for each peer group for most parent organizations in a market area. To drive quality improvement, policymakers would need to choose an appropriate amount of payment to fund the reward pool and an effective performance-to-points scale methodology.

Mandated report: Impact of changes in the 21st Century Cures Act to risk adjustment for Medicare Advantage enrollees

In Chapter 4, the Commission responds to a mandate in the 21st Century Cures Act that directs it to evaluate the impact of the changes CMS has made to the CMS hierarchical condition category (CMS–HCC) model that is used to risk adjust payments in the MA program.

The Medicare program pays managed care plans that participate in MA a monthly capitated amount to provide Medicare-covered services to its Medicare enrollees. Payment for each enrollee has two parts: a base rate and a risk score. The base rates vary by county, and the base rate for a given county reflects the payment for an MA enrollee in that county with the health status of the national average beneficiary in fee-for-service (FFS) Medicare. The risk score indicates how costly the enrollee would be expected to be in FFS Medicare, relative to the national average FFS beneficiary.

The 21st Century Cures Act of 2016 directs the Secretary to make or consider several changes to the CMS–HCC model, which CMS uses to calculate the risk scores used to adjust MA capitated payments for enrollees. CMS has implemented the changes incrementally: different adjustments for full-benefit and partial-benefit dual-eligible beneficiaries in 2017; adjustments for mental health and substance abuse disorders and chronic kidney disease in 2019; and adjustments for the number of beneficiaries’ conditions in 2020.

We have evaluated the impact of the changes that CMS has made to the CMS–HCC model (and the use of two years of diagnosis data, which CMS has not yet implemented) and found the following:

- Each change produces accurate payment adjustments for groups that have characteristics defined by variables in the model.
- Making distinctly different adjustments for full-benefit dual-eligible beneficiaries and partial-benefit dual-eligible beneficiaries eliminates systematic underpayments for the full-benefit dual-eligible beneficiaries and systematic overpayments for the partial-benefit dual-eligible beneficiaries that had occurred in previous models that did not distinguish between these two populations.

- Adding variables to the CMS–HCC model for mental health and substance abuse disorders and chronic kidney disease improves how accurately the model adjusts payments for beneficiaries who have those conditions. However, adding such variables to the CMS–HCC model can provide additional opportunities for MA plans to increase revenue by coding more medical conditions.
- Adding indicators for the number of medical conditions for each beneficiary improves the model’s accuracy in adjusting payments for beneficiaries who have no conditions indicated in the model and those who have many conditions.
- Using two years of diagnosis data to determine beneficiaries’ conditions is a straightforward and effective method for addressing problems related to differences in coding intensity of medical conditions between MA and FFS Medicare.
- All of the models produce underpayments for beneficiaries with very high levels of Medicare spending and overpayments for those with very low levels of Medicare spending. These payment inaccuracies have been a persistent issue for MA risk adjustment.

We commend the progress that CMS has made in implementing the changes to the CMS–HCC model mandated by the 21st Century Cures Act. We encourage CMS to continue its work on this issue to complete the requirements in the 21st Century Cures Act by the mandated date of January 1, 2022.

Realigning incentives in Medicare Part D

In Chapter 5, the Commission proposes a package of recommendations to reform Part D to limit enrollees’ out-of-pocket (OOP) spending; realign plan and manufacturer incentives to help restore the role of risk-based, capitated payments; and eliminate features of the current program that distort market incentives. These reforms will better align the incentives in Part D with the interests of the Medicare program and its beneficiaries. The package of recommendations builds on the major changes the Commission recommended in 2016 to Part D’s benefit structure that would have plan sponsors bear more financial risk for their enrollees’ drug spending while, at the same time, providing sponsors with greater flexibility to use formulary tools. Changes in law and the expanded use of

high-priced drugs since that time have further eroded the competitive incentives for cost control and have made our new package of recommendations even more crucial.

We recommend restructuring Part D in the following ways:

- For spending below the catastrophic threshold, there would be a standard benefit for all enrollees in which plans would become responsible for 75 percent of spending between the deductible and the catastrophic threshold, with enrollees responsible for the remaining 25 percent through cost sharing. (The proposal would eliminate the manufacturers' coverage-gap discount that currently applies to enrollees without the low-income subsidy (LIS) and remove the coverage gap for LIS enrollees. Because cost sharing for LIS enrollees is limited to nominal copayments, Medicare's LIS would cover most or all of those enrollees' cost sharing.)
- For spending above the catastrophic threshold, the restructured benefit would provide enrollees with greater financial protection by adding an annual cap on beneficiaries' out-of-pocket (OOP) costs. The policy would shift insurance risk from Medicare to plan sponsors and drug manufacturers. Plan sponsors would be liable for more spending in the catastrophic phase than the current 15 percent. A new manufacturers' discount of at least 30 percent would be more likely to apply to drugs and biologics that command high prices, potentially acting as a drag on price growth. (The discount could be structured so that if prices of drugs that were subject to the discount increased faster than a benchmark, the discount rate would increase commensurately.)

The reduction in reinsurance payments and increase in plan liability for spending in the catastrophic phase would be phased in during a transition period so that plan sponsors could adjust to the new distribution of risk. The other elements of the new benefit structure—eliminating the coverage gap, establishing a new discount program in the catastrophic phase, and adding an annual cap on beneficiary OOP costs—would be implemented without a transition.

There are several consequences and actions that would result from these reforms. Sponsors would incorporate lower expected Medicare reinsurance subsidies and higher expected benefit liability into plan bids. Because

Medicare's overall subsidy of basic benefits would remain at 74.5 percent, Medicare's capitated payments to plans would increase to incorporate their new higher benefit liability.

It would be critically important for CMS to recalibrate Part D's risk adjustment model to reflect the increased plan liability. The proposed reforms would result in higher capitated payments for all enrollees, with a larger impact, in dollar terms, for LIS beneficiaries. Given the structure of the risk adjustment model, we believe that CMS would be able to recalibrate the model to ensure that overall payment rates would be adequate for both LIS enrollees and other Part D beneficiaries and for smaller plan sponsors that enroll a higher share of LIS beneficiaries.

Finally, because plans will hold greater insurance risk under the reform, policymakers could consider making the Part D risk corridors more generous to temporarily provide plan sponsors with greater protection during a transition to the new benefit structure. Policymakers could also consider different risk-sharing percentages in the corridors to increase plans' aggregate stop-loss protection. While the enhanced protection would be available to all plans, in practice, the protection would be particularly valuable for smaller plan sponsors that do not have the scale to spread the insurance risk or the capital to reinsure themselves.

Separately payable drugs in the hospital outpatient prospective payment system

In Chapter 6, the Commission specifically considers separately payable drugs in the hospital outpatient prospective payment system (OPPS), although the issues we consider in the chapter have broader implications.

The unit of payment in the OPPS is the primary service (the reason for the visit) coupled with the ancillary items provided with the primary service. That is, the OPPS typically packages the cost of ancillary items into the payment rate of the related primary service. Combining a primary service and related ancillary items into a single payment unit encourages efficiency because the combination of inputs used to treat a patient determines whether the provider experiences a financial gain or loss. However, not all ancillary items are packaged.

A category of ancillary items that has grown in importance in the OPPS is drugs covered under Medicare Part B. The OPPS has two distinct policies for paying some drugs separately from primary services: pass-through drugs and

separately payable non-pass-through (SPNPT) drugs. The pass-through program is intended to provide adequate payment to hospitals for drugs that are relatively costly and new to the market. In contrast, the SPNPT program is intended to provide adequate payment for relatively high-cost drugs that are already established in the drug market. Under both policies, each drug has its own payment rate. Total Medicare spending (combined program spending and beneficiary cost sharing) for pass-through drugs and SPNPT drugs has grown rapidly, increasing from \$5.1 billion in 2011 to \$12.9 billion in 2018. Most of that growth in drug spending—82 percent—was for cancer treatment drugs.

The current criteria for both pass-through drugs and SPNPT drugs have been in place for more than 15 years. We are concerned that the criteria for eligibility under both policies do not strike an appropriate balance between promoting innovation and maintaining pressure on providers to be efficient. Both policies use cost criteria to identify drugs for program eligibility. The cost criteria are different between the programs, but we are concerned that both allow eligibility for drugs that should be packaged. Also, neither policy requires drugs to show that they are clinically superior to competing drugs, even though a requirement for clinical superiority implicitly encourages innovation. As a result, Medicare could pay separately for a drug no more effective than an existing product, even when the cost of the existing product is reflected in the OPPS payment—resulting in double payments by Medicare.

At this point in our analysis, we conclude that an effective system of separately payable drugs should have two features:

- Some drugs should be paid separately because they are not ancillary. These drugs are the purpose for a visit, are high cost, treat a condition, and are usually administered by infusion.
- Drugs should show clinical superiority over other drugs to have separately payable status. A clinical superiority requirement is vital to prevent double payments by Medicare.

In future work, we will perform analyses to determine other criteria for identifying drugs that should be separately payable. We will also perform analysis to determine the parameters for those criteria.

Improving Medicare’s end-stage renal disease prospective payment system

Medicare pays dialysis facilities under a prospective payment system (PPS) that is based on a bundle of services that includes end-stage renal disease (ESRD) drugs (including biologics), clinical laboratory tests, and other items and services. In Chapter 7, the Commission recommends two changes to current payment policy.

First, the Commission recommends that the Congress direct the Secretary to eliminate the transitional drug add-on payment adjustment (TDAPA) for new drugs that are in an existing ESRD functional category already included in the payment bundle. Eliminating the TDAPA would (1) maintain the structure of the ESRD PPS and avoid the introduction of incentives to unbundle services covered under the PPS and (2) create pressure for drug manufacturers to constrain the growth of prices for new and existing ESRD drugs. At market entry, such new drugs would be included in the ESRD PPS bundle without an update to the base payment rate. As new products are added to the bundle and diffused into medical practice, it will be important to monitor the use of ESRD drugs, changes in beneficiaries’ outcomes, and the alignment of Medicare payments with providers’ costs to evaluate whether a change in the bundled payment is warranted.

Second, the Commission recommends that the Secretary replace the current low-volume payment adjustment (LVPA) and the rural adjustment with a single payment adjustment for dialysis facilities that are isolated and consistently have low volume—where low-volume criteria are empirically derived. The Commission believes that neither the current LVPA nor the current rural adjustment accurately targets facilities that are both critical to beneficiary access and have high costs warranting a payment adjustment.

The Commission modeled a policy—the low-volume and isolated (LVI) adjustment—under which facilities that are low volume and isolated are defined based on both a facility’s distance from the nearest facility and total treatment volume. In 2017, the illustrative LVI policy would have applied to 575 freestanding and hospital-based dialysis facilities, compared with 336 facilities receiving the current LVPA and 1,257 facilities receiving the rural adjustment. The LVI policy would not apply to facilities that furnish a high volume of treatments because their economies of scale generally result in lower average treatment costs compared with low-volume facilities.

The LVI policy would also not apply to facilities that are in close proximity to another dialysis facility since such facilities are not the sole providers of dialysis services in their communities and thus are not critical to maintaining

access to care. Overall, the LVI policy would better target payment adjustments to the facilities that are most important for maintaining access to dialysis services and would improve the value of Medicare's spending. ■

CHAPTER

1

**Realizing the promise
of value-based payment
in Medicare:
An agenda for change**

Realizing the promise of value-based payment in Medicare: An agenda for change

Introduction

The Commission contends that the growth in spending for the Medicare program poses a significant challenge for the federal government. In 2018, Medicare accounted for 3.6 percent of the country’s gross domestic product, and that figure will grow to 4.7 percent by 2027 under current policies. Most of this growth (70 percent) is due to increases in per capita spending (Congressional Budget Office 2019). The expected growth in per capita spending primarily reflects continued growth in payment rates rather than growth in service use. As the population ages, the number of workers per Medicare beneficiary is expected to decline—from 3.0 in 2019 to a projected 2.5 in 2029—making the financing of the program more challenging. The program’s Part A trust fund, which pays for services such as inpatient care and post-acute care, is projected to exhaust its reserves in 2026, which will force Medicare to sharply reduce payment rates for Part A providers unless policymakers take some other action (Boards of Trustees 2019). A growing share of program spending—for Part B and Part D benefits—is paid for by general revenues, which are partly financed by deficit spending (Medicare Payment Advisory Commission 2020). Without deliberate changes to the program, this growth in spending could result in dramatic changes to the Medicare program and/or its financing.

The Commission contends that policymakers will need to address this unsustainable trend by changing both how

Medicare pays providers and how services are organized and delivered. A common element for these changes should be the use of value-based payment (VBP), which characterizes methods of paying for health care services that provide stronger incentives to control overall costs than traditional fee-for-service (FFS) while maintaining or improving quality.

This chapter outlines a multiyear Commission effort to establish a strategic direction for Medicare payment policy and delivery system design that could be implemented by the Congress and CMS. This work will be guided by the same fundamental principles that serve as the foundation for all of our policy development: ensuring that beneficiaries have access to high-quality care in an appropriate setting, paying providers equitably and giving them incentives to supply efficient and appropriate care, and ensuring the best use of the taxpayer dollars that finance most of Medicare’s spending. This effort will be aimed at identifying changes that broaden the use of VBP by encouraging more providers to organize into entities (which we refer to here generically as “accountable entities”) that are capable of receiving payments from Medicare that require accepting accountability for both the cost and the overall health of a group of beneficiaries. This accountability includes attention to the quality of care, information that beneficiaries can use to compare the care provided by the entities in their area, the systematic provision of preventive services and early detection of

disease, the avoidance of waste, and the delivery of care at the most appropriate and cost-effective site of service.

Medicare Advantage and accountable care organizations could provide a foundation for expanding value-based payment

Although the traditional FFS program has long been Medicare's primary payment mechanism, about 65 percent of the beneficiaries who have both Part A and Part B coverage are now in two other payment models that have stronger incentives to manage overall spending:

- Almost 24 million beneficiaries (about 42 percent of all beneficiaries with Part A and Part B) are enrolled in Medicare Advantage (MA) plans, which receive capitated payments to provide the Part A and Part B benefit package.
- About 13 million beneficiaries (about 23 percent of all beneficiaries with Part A and Part B) are assigned to accountable care organizations (ACOs), which are groups of FFS providers that have incentives to control overall spending and improve quality.¹

The MA and ACO programs could serve as vehicles to broaden the use of VBP in Medicare, but both programs need to be improved before they can realize that potential. While these programs may be capable of reducing spending relative to the FFS program, whether they actually produce substantial savings depends heavily on how they are structured. For example, 82 percent of MA plans indicate in their bids that they can provide the Part A and Part B benefit package at a lower cost than the FFS program, but the current MA program nevertheless increases overall program spending relative to FFS because MA benchmarks are substantially higher than FFS costs in some areas, many plans receive rebates and quality bonuses, and plans can receive higher payments by submitting more diagnosis codes (Medicare Payment Advisory Commission 2020).

The Commission asserts that broader acceptance in Medicare of accountability for overall costs and outcomes will require improvements to both the existing ACO and MA models. Researchers who have studied the various ACO programs that Medicare has operated over the past 15 years have typically found that they generated modest

savings, on the order of 1 percent to 2 percent of total spending. Whether ACOs will produce larger savings in the future is unclear. CMS has made changes to the largest ACO program—the Medicare Shared Savings Program (MSSP)—that have some positive elements, such as encouraging ACOs to bear more financial risk, but on balance the changes may, in fact, reduce savings for Medicare. In this report, we make a recommendation to protect program savings generated by ACOs in the MSSP by using national provider identifiers instead of tax identification numbers to calculate both performance-year and baseline-year spending.

The Commission plans to conduct further analysis to identify specific policy changes that will improve ACOs and ACO-like models. Any policy changes that we might recommend would be aimed at making ACOs more effective; changes that would, for instance, simply increase funding for ACOs or encourage the creation of ineffective ACOs would provide little, if any, incremental value. Two examples of areas where additional work may be needed (which are discussed in more detail later, in this report's chapter on ACOs) illustrate the complex challenges involved:

- ACOs may be more effective in the longer term if they also have incentives to manage the use of costly prescription drugs. ACOs are currently responsible for the cost of Part A and Part B services only, which includes physician-administered drugs covered under Part B, but does not include outpatient prescription drugs covered under Part D. However, making ACOs more accountable for outpatient prescription drug costs would be challenging because a separate group of entities (Part D plans) already has some financial responsibility for those costs.
- ACOs may be more effective if they have the understanding and support of beneficiaries, who usually do not know that they have been assigned to an ACO and may not be aware of the potential benefits of better-coordinated care. Beneficiaries might be more engaged with ACOs if there were changes to Medigap coverage of out-of-pocket costs and/or financial incentives from ACOs that would encourage beneficiaries to receive care from ACO providers.

Any changes that we might recommend in these and other areas would be intended to increase the chance that these models will be successful. As models improve, we would

support Medicare increasing incentives for providers to participate in them and improve delivery of care.

This work also includes improving the accountability of MA plans to the program and beneficiaries. Over the past several years, we have highlighted numerous shortcomings in the system that Medicare uses to reward plans with high quality ratings. In this report, we recommend the adoption of a new MA value incentive program that would reduce program spending and give beneficiaries better information about the quality of the plans in their area. In the future, we may examine other important aspects of the MA program, such as the benchmarks that help determine plan payment rates and the risk adjustment system.

The Commission may also explore ways to expand the use of value-based payment outside of the scope of the current ACO and MA programs. For example, there is some concern that hospitals have relatively weak incentives, or actually counterincentives, to reduce program spending under the ACO approach. One potential alternative that could give hospitals stronger incentives, but also raises challenging design issues, would be for Medicare to pay hospitals using global budgets that cover all of their inpatient and outpatient services. The state of Maryland is currently testing the use of global budgets for its hospitals in a demonstration under which the hospitals are paid on an FFS basis, but their rates are adjusted to ensure that their overall payments equal a predetermined amount. However, the demonstration's effects have been mixed (hospital spending has decreased, but the effect on overall spending is unclear) and Maryland's approach would be difficult to use at the national level because the state's hospital payments are much higher than traditional Medicare payments. Another issue that may deserve further examination is the possibility of expanding the use of other payment models, such as bundled payments for certain episodes of care, and the need to ensure that those models are well integrated with ACOs.

The problem of fee-for-service payment

Beyond improving the current ACO and MA models, the Commission asserts that, where possible, Medicare should look for ways to further evolve away from the traditional FFS model by identifying policy changes that would dampen its incentives to provide more services while, at the same time, maintaining or improving quality.

Medicare has already made significant efforts to reduce the incentives to provide more services:

- Many FFS payment systems use prospective payments and bundle the payments for related services into a single rate. For example, Medicare pays hospitals a fixed amount for many condition-based episodes of service (through the diagnosis related groups (DRGs) used for inpatient services and the ambulatory payment classifications used for many outpatient services), pays for home health on a per episode basis, and pays for skilled nursing care and most hospice care using daily rates. This approach gives providers an incentive to deliver care efficiently by constraining costs within the episode of service, but it does not limit the number of episodes provided and, to the extent that payments for certain episodes are profitable, could actually spur the provision of unnecessary services.
- Medicare pays private insurers in the MA program a monthly prospective payment for each enrollee. Some plans, in turn, pay delivery system intermediaries (such as an integrated delivery system) a prospective payment for each enrollee. This approach is one example of how providers can be paid using prospective global payment, sometimes referred to as “capitation payment.” However, most plans pay providers on a traditional FFS basis. Consideration could be given for Medicare to encourage plans to increase the use of such global payments to providers. One potential benefit of global payments is that providers would have more predictable revenues than they do under FFS, which could mitigate instability during service disruptions such as those that many providers have experienced due to the coronavirus pandemic.
- Medicare pays ACOs based on a variety of payment models, such as bonus-only payments for meeting quality and cost management benchmarks or bonuses based on both upside and downside risk. A small number of ACOs are paid using a capitation model. ACOs may pay individual physician providers based on a variety of payment methods, such as FFS payment, salary with or without volume incentives, or value arrangements such as quality bonuses. Consideration could be given for Medicare to encourage ACOs to pay providers in ways that encourage the delivery of appropriate services

and discourage the provision of unnecessary or inappropriate services.

These and other exceptions to the pure FFS payment model are attempts to constrain the unit cost of services, the number of services provided, or both. These different payment models have had varying levels of success: DRGs have helped constrain Medicare costs, but payments to MA plans have consistently been higher than FFS costs due to the way that Medicare sets plan payment rates, and ACOs have generated only modest savings.

Although the FFS program encourages greater service use, one positive feature of the program is that most of its payment systems use administered prices to pay for services. The use of administered pricing has been helpful in exerting financial pressure on providers and has played a key role in constraining cost growth, especially in recent years as providers have consolidated and negotiated higher commercial rates. For example, Medicare's control over prices is the primary reason its costs have grown more slowly than commercial insurance premiums in recent years. Since Medicare is on a financially unsustainable trajectory, efforts to broaden the use of value-based payment (which focus largely on changing patterns of service use) should be carefully carried out to ensure that they do not inadvertently undermine the program's control over prices.

However, under FFS payment, Medicare beneficiaries may experience significant variability in the quality and appropriateness of services provided and in their resulting outcomes. For example, rates for avoidable hospitalizations and emergency department visits vary across market areas, indicating that there may be opportunities to improve the quality of FFS ambulatory care (Medicare Payment Advisory Commission 2020). There can also be substantial variation in quality within a given type of provider, such as inpatient hospitals (Medicare Payment Advisory Commission 2019). Unfortunately, policymakers now have little ability to compare quality across the FFS, ACO, and MA sectors, and in response, the Commission has supported the use of a small set of outcome, patient experience, and value measures to facilitate those comparisons (Medicare Payment Advisory Commission 2018).

Beneficiaries in the FFS program may also face significant out-of-pocket costs. Traditional Medicare has deductibles for Part A and Part B services, charges copayments or coinsurance for many services, and does not have an

annual cap on beneficiary out-of-pocket costs. As a result, almost 90 percent of beneficiaries have some type of supplemental coverage, such as a Medigap policy, that protects them from high out-of-pocket costs (but also encourages them to use more services). Unlike the FFS program, all MA plans have an annual cap on out-of-pocket costs and cover some Part A and Part B cost sharing. Plans often finance these extra benefits using their MA rebates, which allows many enrollees to obtain some of the same protections as a Medigap policy without having to pay a premium. These extra benefits are one reason that MA plans have become increasingly popular, with many new beneficiaries first enrolling in FFS and then switching to a plan a few years later.

Beneficiaries also experience variable levels of support outside of their direct, physical contact with the delivery system. For example, FFS Medicare does not cover supporting services like transportation, nor does it support the development of preemptive care plans such as population health models that identify gaps in care and seek to close those gaps.

Although administered pricing has helped control spending growth in many parts of the FFS program, it nonetheless has drawbacks. Some services are inevitably mispriced, and payment rates that are too high may encourage inappropriate growth in utilization, as has happened in the past with services such as advanced imaging, therapy in skilled nursing facilities, and durable medical equipment. FFS payment also may contain incentives to overuse new services or lack incentives to provide services that do not have a distinct billing code, such as efforts to address social determinants of health. MA plans and some ACO models may have more opportunity to develop innovative care models in these areas.

A need for change

FFS contains inherent incentives for the delivery system to provide more services and thus receive more payments.² The effects of those incentives are not limited to the FFS program; they also affect how MA plans and ACOs are paid (see next paragraph). Medicare has some counterincentives to avoid the provision of unnecessary or inappropriate services, but they need to be strengthened. The FFS system increases Medicare costs, based on higher than necessary use of services and, in some instances,

the provision of care at higher cost sites of service. The incentive to provide more services also potentially exposes beneficiaries to unnecessary health risks, such as hospital-acquired infections, and to the extra out-of-pocket costs of unnecessary or inappropriate services. Delivery systems that provide care coordination across the continuum of care settings are the exception rather than the norm. There are clearly opportunities for Medicare to provide better value given the large amounts that taxpayers and beneficiaries spend on the program. Finally, the current system does not support sufficient accountability or transparency, such as providing beneficiaries with information that compares the quality of care provided by different models such as FFS, health plans, or ACOs.

The Commission asserts that the development of alternative payment models and care delivery models needs to accelerate.³ There have been numerous efforts by the Congress, CMS (most notably through the Center for Medicare & Medicaid Innovation (CMMI)), and the private sector to address these challenges through MA plans, ACOs, and smaller scale payment and delivery models such as Bundled Payments for Care Improvement (which gives providers incentives to reduce the overall costs for an episode of care) and Comprehensive Primary Care Plus (which makes extra payments to primary care practices that provide more extensive care coordination). Despite these efforts, the development of new payment and care delivery models has had relatively little impact on the average beneficiary and has lagged well behind what is possible and desirable. Policymakers should look for ways to make CMMI more effective so that Medicare can better serve the growing needs of its enrollees.

The Commission contends that unless changes are made to how Medicare pays for services, the cost of the Medicare program will become unsustainable for the country, which could necessitate dramatic changes to the Medicare program and/or its financing. The Commission also contends that the quality of the program will be best served if incentives are aligned between Medicare, the delivery system (through accountable entities), and beneficiaries.

Future vision for the Medicare program

Medicare has used an FFS model to pay for services throughout its history. The FFS program continues to play a central role today, even within the MA and

ACO programs. For example, MA plans bid against benchmarks that equal a percentage of FFS spending, and MA plans are allowed to use FFS rates to pay out-of-network providers (instead of the much higher rates that commercial insurers typically have to pay in those situations). Similarly, the benchmarks that determine whether ACOs qualify for shared savings are tied to FFS spending, and Medicare continues to pay the vast majority of providers affiliated with ACOs on an FFS basis. Medicare's FFS rates are also widely used as a reference point or benchmark by other parts of the health care system.

The FFS model is deeply embedded in our health care system and will probably continue to play an important role after new payment and delivery models are developed. For example, policymakers might use FFS rates to inform the determination of funding amounts for accountable entities, accountable entities might pay for out-of-network or referral services on an FFS basis, and Medicare might continue using the FFS model to pay for care in areas that do not have accountable entities, such as rural areas. Policymakers should thus work to improve the FFS model even as they pursue the development of new payment and delivery models.

Nevertheless, the Commission asserts that the use of FFS payment for Medicare services should be replaced, over time and to the degree feasible, by systems that have incentives to:

- reduce Medicare's financial burden on taxpayers and beneficiaries;
- provide all necessary covered services, including preventive services and early disease detection;
- avoid delivering unnecessary, inappropriate, or low-value services;
- control the costs of providing appropriate and necessary services;
- deliver chronic care services through a care model that features care coordination among providers;
- improve the quality of services and the patient experience of care;
- address and coordinate both the medical and nonmedical needs of beneficiaries; and

- embrace the use of new technologies within payment models that have incentives to reduce program spending or improve quality.

As policymakers develop accountable entities, they may need to consider whether Medicare should support the use of value-based payment by specifying the mechanisms that those entities use to pay individual providers. This approach would represent a departure from current Medicare policy. Medicare has typically stayed out of “downstream” payment arrangements that entities such as MA plans and ACOs use to pay their providers: For example, MA plans have flexibility to negotiate their own payment arrangements with providers, and ACOs have flexibility to determine how shared savings payments are allocated among their participating providers.

Policymakers could find it difficult to develop requirements that account for the range of provider types that deliver Medicare services and the variation in local health care delivery systems. Efforts to promote the use of VBP in the commercial sector have had relatively modest effects to date, and CMS might find that developing and administering requirements in this area would be challenging and prone to unintended consequences. Given these concerns, one approach would be for policymakers to focus on giving accountable entities stronger incentives to control costs and improve quality and then rely on those entities to develop the most effective payment arrangements to meet those goals.

However, as Medicare gains experience with value-based payment, policymakers may be able to develop ways to assess and monitor downstream payment arrangements and determine which methods of value-based payment are more effective. If this happens, Medicare could consider creating incentives that encourage accountable entities to use these models more widely, which could lead to a reduction in the provision of inappropriate and unnecessary services, encourage the delivery of preventive and early disease detection services, facilitate better care coordination among providers, and lower beneficiary out-of-pocket costs, thus justifying the added administrative burden.

Under an improved Medicare program, most beneficiaries would be able to receive their care through a variety of accountable entities that have incentives to both control overall costs and improve quality. Medicare would ideally design incentives that encourage beneficiaries to choose one of these entities to receive their care. Medicare could also strengthen providers’ incentive to participate by reducing FFS payment rates for providers that are not part of an accountable entity. The Commission recognizes that, traditionally, the health care delivery system has been slow to change, and as a result, much of Medicare’s payment apparatus remains connected to legacy payment models. However, the coronavirus pandemic has demonstrated that the system is capable of rapid change when circumstances require it to do so. The Commission asserts that the financing challenges facing the program, its beneficiaries, and the taxpayers who fund it require a similar systemic response to ensure Medicare’s ongoing sustainability. ■

Endnotes

- 1 That figure includes approximately 1 million beneficiaries in Maryland's total cost of care program.
- 2 The FFS incentive to provide more services is reinforced by the widespread use of supplemental coverage to cover some or all of Medicare's out-of-pocket costs. Almost 90 percent of beneficiaries have some type of supplemental coverage. A Commission-sponsored study estimated that spending for elderly beneficiaries with Medigap coverage was 33 percent higher than for those with no supplemental coverage, after controlling for demographics, education, income, and health status (Hogan 2009).
- 3 The steps taken by policymakers and health care providers to address the coronavirus pandemic demonstrate that the delivery system is capable of rapid change. Policymakers and researchers will need to evaluate the effects of recent legislative and regulatory changes on Medicare spending and outcomes to determine which policy changes are worth keeping in place once the pandemic has ended.

References

Boards of Trustees, Federal Hospital Insurance and Federal Supplementary Medical Insurance Trust Funds. 2019. *2019 annual report of the Boards of Trustees of the Federal Hospital Insurance and Federal Supplementary Medical Insurance Trust Funds*. Washington, DC: Boards of Trustees.

Congressional Budget Office. 2019. *The budget and economic outlook: 2019 to 2029*. Washington, DC: CBO.

Hogan, C. 2009. *Exploring the effects of secondary insurance on Medicare spending for the elderly*. A study conducted by staff of Direct Research LLC for MedPAC. Washington, DC: MedPAC.

Medicare Payment Advisory Commission. 2020. *Report to the Congress: Medicare payment policy*. Washington, DC: MedPAC.

Medicare Payment Advisory Commission. 2019. *Report to the Congress: Medicare payment policy*. Washington, DC: MedPAC.

Medicare Payment Advisory Commission. 2018. *Report to the Congress: Medicare payment policy*. Washington, DC: MedPAC.

CHAPTER

2

**Challenges in maintaining
and increasing savings from
accountable care organizations**

R E C O M M E N D A T I O N

- 2** The Secretary should use the same set of national provider identifiers to compute both performance-year and baseline assignment for accountable care organizations in the Medicare Shared Savings Program.

COMMISSIONER VOTES: YES 16 • NO 0 • NOT VOTING 0 • ABSENT 1

Challenges in maintaining and increasing savings from accountable care organizations

Chapter summary

CMS has made it a priority to move more Medicare beneficiaries into alternative payment models in which providers are responsible for the cost and quality of care. One such model is the accountable care organization (ACO). ACOs are now responsible for 23 percent of Medicare beneficiaries with Part A and Part B coverage. Given the rapid growth in ACOs, it is important to evaluate whether ACOs are generating savings for the Medicare program and thus helping make the program more sustainable. Our work evaluates past savings, examines strategies to increase savings, and discusses how the savings are at risk if program vulnerabilities result in unwarranted shared savings payments to ACOs.

ACOs' savings have been modest

To date, ACOs have generated modest savings, with most evaluations estimating 1 percent to 2 percent reductions in spending from existing ACO models. The Medicare ACO savings stem from small reductions in hospital inpatient, hospital outpatient, and post-acute care use. There have also been savings in at least one commercial ACO according to recent evaluations. The Alternative Quality Contract (AQC) ACO in Massachusetts found material gross savings and modest net savings after accounting for incentive payments to ACOs. AQC savings were primarily due to reduced laboratory testing, imaging, and emergency department visits. Some savings were also generated by using lower priced providers. The larger savings in the commercial ACO

In this chapter

- Background
- Proposed strategies to increase ACO savings
- Potential for unwarranted shared savings from patient selection
- Use of NPI for assignment would improve benchmark validity and reduce unintended incentives

should be expected given that the AQC model evaluated is housed in an HMO that—unlike Medicare ACOs—can use prior authorizations to restrict service use and has the ability to steer patients to lower priced providers.

Some have expressed a concern that the ability of Medicare ACOs to achieve savings has been limited because key constituencies are not sufficiently engaged with ACOs and have incentives that run counter to those of ACOs. CMS and others have expressed an interest in trying to enhance ACOs' ability to generate savings by creating greater engagement with beneficiaries and with specialists, reducing hospital incentives to increase services, and creating incentives for ACOs to control prescription drug use under Part D. However, all four of these strategies involve implementation challenges.

Technical change to reduce unwarranted shared savings from patient selection

Because Medicare savings from Medicare Shared Savings Program ACOs have been relatively small thus far (although still greater than most care coordination demonstrations), there is a risk that those savings could be eroded, or even completely offset, by unwarranted shared savings payments. Unwarranted payments can result if there is patient selection in ACOs, whether intentional or not. For example, if high-cost beneficiaries are disproportionately shifted out of an ACO in its performance year while remaining in the baseline years, performance-year spending will decrease in relation to the ACO's benchmark. This selection can occur if high-cost clinicians are removed from the ACO or if clinicians with high-cost beneficiaries bill under a taxpayer identification number (TIN) that is not part of the ACO. A second means of patient selection involves removing just a portion of a high-cost provider's patients from the ACO. The clinician could bill for patients with low spending under the ACO's TINs and bill for patients with higher spending relative to their risk score under a non-ACO TIN.

The Commission does not believe widespread patient selection occurred in the program's early years. However, the current system allows an ACO to strategically change the composition of its TINs to increase the likelihood of receiving unwarranted shared savings relative to benchmarks, creating a vulnerability for the Medicare program.

To reduce the incentives to select patients and providers, and to reduce the potential mismatch between the clinicians considered in an ACO's baseline years and its performance years, the Commission recommends that the Secretary determine an ACO's historical baseline spending using the same national provider identifiers (NPIs) that are used to compute the ACO's performance-year spending. Properly

matching the clinicians included in an ACO's baseline and performance years will allow a more accurate assessment of an ACO's performance and reduce opportunities for unwarranted shared savings. While there will always be some shared savings payments due to random variation, we should minimize opportunities for unwarranted shared savings payments due to favorable provider or patient selection. In other words, ACOs should be rewarded for achieving real savings due to improving patient outcomes and appropriately managing utilization—not for apparent gains that result from unnecessary mismatches between the clinicians included in performance-year and baseline-year (benchmark) calculations. ■

Background

Organizations of providers that agree to be held accountable for the cost and quality of care are called accountable care organizations (ACOs). The goal of ACOs is to create an incentive for providers to control spending growth and improve quality for a population of Medicare fee-for-service (FFS) beneficiaries. Because ACOs are provided with claims data for their beneficiaries, they can theoretically improve care coordination and encourage their beneficiaries to use more efficient providers—though beneficiaries still have the freedom to choose to receive their care from any Medicare-participating provider. Compared with Medicare Advantage (MA) plans, ACOs have fewer tools to control use (e.g., they cannot limit provider networks, cannot require prior authorization), but they also have lower marketing and administrative costs.

Almost a quarter (23 percent) of Medicare beneficiaries with both Part A and Part B coverage are assigned to ACOs. CMS assigns beneficiaries to an ACO if they have a plurality of primary care visits with clinicians who participate in the ACO. Most of these beneficiaries are assigned to ACOs in the Medicare Shared Savings Program (MSSP), a permanent ACO model established through the Affordable Care Act of 2010 (ACA). Since its inception in April 2012, the MSSP has grown rapidly. In 2020, there are 517 MSSP ACOs responsible for the cost and quality of care provided to 11.2 million FFS beneficiaries. Although this chapter focuses on the MSSP, CMS has also operated a series of ACO-related demonstration programs through the Center for Medicare & Medicaid Innovation (CMMI), including separate programs in Maryland and Vermont. In addition, private insurers (including parent organizations of MA plans and commercial insurers) also operate ACOs.

For each ACO, CMS sets a spending target for a beneficiary population assigned to that ACO. This target is called a benchmark. If Medicare spending for care provided to an ACO's assigned beneficiaries is below this benchmark, the ACO can receive "shared savings" payments, which can range from 50 percent to 100 percent of shared savings in different ACO models. If Medicare spending is above the benchmark, the ACO may share liability, depending on its risk arrangement with Medicare. Under a one-sided risk arrangement, the ACO bears no liability for spending exceeding its benchmark. Under a two-sided risk arrangement, the ACO may be liable for

some share of the difference between actual spending and the benchmark. CMS must strike a balance when setting ACO benchmark rules. If CMS sets benchmarks too low, providers could doubt their ability to generate savings and could therefore avoid participating in the program (especially in two-sided risk arrangements). In contrast, if CMS sets benchmarks too high, providers would be able to keep spending under the benchmarks without appreciably altering the provision of care, thereby receiving unwarranted "shared savings" payments. In this scenario, the ACO program would cause overall Medicare spending to increase rather than decrease.

To date, ACOs have generated relatively small savings, but those savings are nevertheless greater than those achieved in most care coordination models in Medicare. We define Medicare savings from an ACO program as savings evaluated against a counterfactual—that is, what spending would have been if the ACO program did not exist. Performance-year savings can be reduced by "shared savings" payments made to the MSSP's participating ACOs to calculate net savings to Medicare. In contrast, CMS's shared savings payments are evaluated relative to the ACOs' benchmarks, not to a counterfactual. Hence, unwarranted shared savings payments can be made if they result from a mismatch between benchmarks and actual spending. Accordingly, ACO models must be designed to minimize opportunities for ACOs to receive unwarranted shared savings payments.

The ACO program has grown rapidly

The MSSP started in 2012 with 114 ACOs in the initial cohort and grew to 561 ACOs by January 2018. In 2019, CMS introduced new MSSP rules, referred to as "Pathways to Success." As of July 2019, there were 518 ACOs in the MSSP (Table 2-1, p. 18), making 2019 the first year in which the number of ACOs leaving the program exceeded the number joining the program.¹ By January 2020, there were 517 ACOs in the MSSP. Despite the decline in numbers of participating ACOs since 2018, the number of assigned beneficiaries in the MSSP has continued to increase every year, with 10.9 million beneficiaries in the program in 2019 and 11.2 million as of January 2020. From 2013 to 2020, the average size of an ACO increased from 14,500 beneficiaries to 21,600 (data not shown).

The Pathways to Success introduced in 2019 created new MSSP models designed to move MSSP ACOs more rapidly to two-sided risk. (See the Commission's *Payment*

**TABLE
2-1**

The number of MSSP ACOs increased through 2018 and has since decreased

	2013	2014	2015	2016	2017	2018	2019*	2020
Beginning of year	220	338	404	433	480	561	518	517
New to program	106 **	123	89	100	99	124	66	53
Left program (previous year)	0	5	23	71	52	43	109	54
Beneficiaries (in millions)	3.2	4.9	7.3	7.7	9.0	10.5	10.9	11.2

Note: MSSP (Medicare Shared Savings Program), ACO (accountable care organization).

*Data as of July 1, 2019. Because of the ACO rule change, in 2019, new ACOs joined in July, not January. Sixty-six ACOs joined in July 2019 and 109 ACOs left the program in the previous year or in 2019 before July 1.

**114 ACOs joined in 2012, the first year of the program.

Source: MedPAC analysis of CMS data.

Basics for more detail: http://medpac.gov/docs/default-source/payment-basics/medpac_payment_basics_19_aco_final_sec.pdf?sfvrsn=0.) Nonetheless, in 2020, most MSSP ACOs remain in one-sided models.

ACO models' savings to date have been modest

Evaluation of various Medicare ACO models and one rigorously evaluated commercial model have shown small ACO savings. Gross savings were larger in the largest commercial ACO program that has undergone a thorough evaluation, but net savings (after incentive payments) were still small. These evaluations all define savings as the difference between actual spending and what spending would have been in the absence of the ACO program (this counterfactual approach is not equivalent to the CMS computation of “shared savings” relative to a benchmark).

Medicare program savings from all ACO models generally have ranged from 1 percent to 2 percent

Over the past 15 years, all of the ACO models evaluated by CMS have generated similar savings, despite key differences in assigning beneficiaries, setting benchmarks, determining comparison groups, and adjusting for risk. Even with these differences, the four early ACO models (the Physician Group Practice Demonstration, the Pioneer ACO demonstration, the initial MSSP model, and the Next Generation ACO model) all appear to have generated modest savings for the Medicare program in the range of 1 percent to 2 percent. (See text box for a history of the savings and incentives of the various ACO models,

pp. 20–21.) For example, our estimate of MSSP savings from 2012 to 2016 showed a 1 percent or 2 percent slower rate of growth for spending on beneficiary populations in MSSP ACOs in 2013 (not accounting for shared savings payments) (Medicare Payment Advisory Commission 2019). Although the estimated savings from these models are modest, they surpass those achieved by a wide variety of care coordination models Medicare has tried. Thus, it is important that these opportunities for program savings be preserved in future ACO models.

However, the latest MSSP model, which began in 2019, is designed to be on balance more favorable to certain ACOs and likely will result in larger “shared savings” payments to participating ACOs given any level of performance. If so, the new MSSP model may not generate any net savings for Medicare, unless the new model has a materially larger effect on service use than did previous ACO models. One concern is that the rules for the new MSSP model create incentives for ACOs to direct resources toward increased diagnostic coding (because risk score increases are now allowed to increase benchmarks) and toward seeking a favorable selection of clinicians and patients (which is easier given regional benchmarks) rather than improving care and reducing unnecessary use of services.

Commercial ACO programs have mechanisms for generating savings that may not be available to the Medicare program

ACOs have become more common within commercial insurance payment models. According to Leavitt Partners, there were 876 commercial ACO contracts in 2019, and

the number has been growing (Muhlestein et al. 2019). Although there are many commercial ACO programs in operation, the most extensively studied commercial ACO program has been the Alternative Quality Contract (AQC) between Blue Cross Blue Shield of Massachusetts and ACOs in the Boston area. It has often been cited as a successful example of how ACOs can operate in the commercial sector. The text box on savings from commercial ACOs (pp. 22–23) summarizes the most recent evaluation of the AQC. Although the evaluation found that the AQC resulted in savings even after incentive payments to the ACOs, that level of savings may not be achieved by Medicare ACOs because Medicare ACOs have fewer tools. For example, savings from switching patients from high-priced to low-priced hospitals would be limited in Medicare because Medicare sets relatively uniform rates for all providers of the same type.

Proposed strategies to increase ACO savings

Some stakeholders have expressed a concern that the ability of ACOs to achieve savings has been constrained because key constituencies have not sufficiently engaged with ACOs. CMS and others have expressed an interest in trying to enhance ACOs' ability to generate savings by creating greater engagement with beneficiaries and specialists, reducing hospital incentives to increase services, and aligning incentives for ACOs and prescription drug plans under Part D. Recent changes in Medicare policy are intended to allow two of these strategies—beneficiary engagement and aligning hospital incentives—to be tested.

Increasing beneficiaries' incentives to engage with an ACO

Initially, ACOs had few tools with which to encourage beneficiaries to become engaged with an ACO. (Beneficiaries are often not aware they are in an ACO and could have difficulty understanding the ACO concept. Engagement with an ACO, therefore, usually translates to engagement with their primary care physician's practice.) Historically, ACOs' primary tool was providing high-quality care and thus convincing beneficiaries that they should continue to see the ACO's primary care physicians. However, beneficiaries often change the physicians they see as their health care needs change or they have issues with their current providers, and about 25 percent of ACO beneficiaries were switched out of their ACO in 2017.

Since 2019, the new MSSP and the proposed CMMI Direct Contracting model have created new tools for beneficiary engagement. ACOs can encourage beneficiaries to consistently use the ACO's primary care practice by providing supplementary benefits such as:

- cash payments of up to \$20 for seeing ACO physicians if the beneficiary is in a two-sided ACO model
- paying for transportation services
- vouchers for chronic disease management programs, wellness programs, or meal programs
- items to support management of chronic disease, such as air-filtering systems or air conditioners
- waiving cost sharing (allowed in the CMMI Direct Contracting model)

ACOs can also have beneficiaries name their primary care physician, which will govern enrollment as long as they have recently used that physician. In a recent proposed rule, CMS also discussed allowing beneficiaries to directly enroll in an ACO similar to beneficiary enrollment in an MA plan (Centers for Medicare & Medicaid Services 2018b). However, some commenting on the rule suggested that the ACO concept may be difficult to explain to beneficiaries and could create confusion between ACOs and MA plans (Centers for Medicare & Medicaid Services 2018a).

Given the wide range of tools ACOs can now use to engage beneficiaries, the question is no longer whether ACOs have the tools to engage a beneficiary. The question is whether the ACOs believe the cost of the extra benefits (borne by the ACO) will be offset by savings from reduced service use if the patient continues to use ACO clinicians.

Increasing hospitals' incentive to reduce unnecessary service use

On average, hospital-led ACOs have not generated savings in the MSSP (McWilliams et al. 2018, Medicare Payment Advisory Commission 2019). Some have attributed this result to hospitals' lack of incentive to reduce volume. Hospitals may prefer increasing FFS revenue through increasing volume over the opportunity to achieve shared savings through reduced volume and revenue. In addition to insufficient hospital incentives, hospital-led ACOs may generate less savings because their typically large physician staffs each have a small individual incentive to act efficiently since the savings from their personal efforts

History of Medicare accountable care organizations

2005 to 2010: The Physician Group Practice Demonstration

- **Population:** 220,000 beneficiaries at 10 organizations selected by the Secretary
- **Key design features:**
 - Benchmark based on historical spending; benchmark growth based on local competitors' spending growth
 - Hierarchical condition category (HCC) coding growth increased benchmarks
 - One-sided risk (bonus only)
 - Retrospective assignment
- **Ways to obtain “shared savings”:**
 - Lower spending growth
 - Increase coding
 - Have local competitors with high spending growth
- **Program savings:** Estimated at 1 percent to 2 percent savings in an average year with net savings (after shared savings payments) of less than 1 percent (RTI International 2012)

2012 to 2016: Pioneer ACO (Center for Medicare & Medicaid Innovation (CMMI) demonstration)

- **Population:** Up to 700,000 beneficiaries in 32 organizations selected by the Secretary (most Pioneer accountable care organizations (ACOs) withdrew from the program before it ended)
- **Key design features:**
 - Benchmark based on historical spending; benchmark growth based on national spending growth rates; evolved to adjust for changes in local prices
 - HCC growth did not affect benchmarks

- One-sided risk (first year) evolving to two-sided risk (bonus and penalty)
- Waiver of three-day skilled nursing facility stay rule
- Beneficiaries could voluntarily align with an ACO
- Prospective assignment
- **Ways to generate “shared savings”:**
 - Lower spending growth
 - Opportunities for patient selection were lower in the Pioneer program than in the Medicare Shared Savings Program (MSSP) due to prospective assignment
- **Shared savings:** Initial year savings estimated between 1 percent and 2 percent before shared savings payments and less than 1 percent after shared savings payments (McWilliams et al. 2015)

2012 to 2019: Initial MSSP shared savings model (the MSSP is permanent)

- **Population:** 10.5 million beneficiaries in 561 ACOs by 2018
- **Key design features:**
 - Benchmark based on historical spending, adjusted for national growth in spending and for changes in local prices
 - HCC growth did not increase benchmarks; HCC declines reduced benchmarks
 - Primarily one-sided risk (bonus only)
 - Retrospective assignment
- **Ways to generate “shared savings”:**
 - Lower spending growth
 - Use wellness visits to maintain assignment of beneficiaries with low utilization

(continued next page)

History of Medicare accountable care organizations (cont.)

- Random variation can benefit ACOs in one-sided (bonus-only) models
- **Shared savings:** Savings estimates depend on year and methods, but still are generally in the 1 percent to 2 percent range before shared savings payments; near 1 percent after shared savings payments (McWilliams et al. 2018, Medicare Payment Advisory Commission 2019)

2015 to 2019: Next Generation (NextGen) ACO model (CMMI demonstration)

- **Population:** 500,000 beneficiaries in 18 ACOs in 2016
- **Key design features:**
 - Benchmark is primarily based on historical spending, adjusted for national spending growth and local price changes
 - HCC growth can increase benchmarks by up to 3 percent, but a common coding adjustment across ACOs reduces some of the coding growth for NextGen ACOs
 - Two-sided risk (bonus and penalty)
 - Prospective assignment
- **Ways to generate “shared savings”:**
 - Lower spending growth
 - Increase coding faster than the coding adjustment applied to all ACOs
- **Shared savings:**
 - First year evaluation: 1 percent to 2 percent reduction—relative to fee-for-service (FFS) Medicare—before shared savings and approximately 1 percent after shared savings payments (NORC at the University of Chicago 2018)
 - Second year evaluation: The evaluation compared the NextGen model against all other FFS Medicare (including MSSP ACOs) and

found no net savings, perhaps in part due to MSSP savings (NORC at the University of Chicago 2020)

2019 onward: New MSSP model (MSSP is a permanent program)

- **Population:** Total MSSP population 10.9 million beneficiaries in 518 ACOs in mid-2019
- **Key design features:**
 - Benchmarks are a blend of historical and regional spending, and benchmark growth is a blend of national and regional growth
 - Asymmetric risk and rewards favor ACOs
 - Allows HCC coding to increase benchmarks up to 3 percent; unlike Medicare Advantage and NextGen, there will be no across-the-board coding adjustment
 - Annual choice of retrospective or prospective assignment
- **Ways to generate “shared savings”:**
 - Lower spending growth
 - Begin with spending levels lower than others in the market
 - Improve patient mix by changing choice of prospective or retrospective assignment from one year to the next
 - More complete coding
 - Random variation rewards are larger than penalties; therefore, expected shared savings due to random variation is positive, but providers must take risk or have a partner take risk
 - Use wellness visits to maintain assignment of beneficiaries with low utilization
 - Adjust which national provider identifiers bill to ACO taxpayer identification numbers to improve patient selection ■

Savings from commercial ACOs may be difficult to replicate in Medicare ACOs

Blue Cross Blue Shield (BCBS) of Massachusetts instituted a two-sided population-based global budget (or accountable care organization (ACO)) contract, called the Alternative Quality Contract (AQC), for some of its commercial enrollees. The AQC was launched in 2009 with provider organizations that collectively cared for about 20 percent of BCBS's HMO members; by 2013, 85 percent of HMO members and providers in the BCBS network had entered the AQC. HMO enrollees select a primary care physician (who controls referrals to specialists); HMO enrollees are then assigned to that primary care physician's ACO. By 2016, the program had experienced lower growth in spending on medical claims for HMO enrollees relative to a comparison group of HMO enrollees across eight northeastern states. By the eighth year of the contract, growth in medical spending for AQC members relative to the comparison group was reduced by an average of 11.7 percent for enrollees in organizations that entered in 2009, 11.9 percent for those entering in 2010, 6.9 percent for those entering in 2011, and 2.3 percent for those entering in 2012 (Song et al. 2019). These

savings are computed before incentive payments to providers, which were larger in the initial years of the program than in the later years. Therefore, net savings were modest. On net, however, Song and colleagues estimated that, using unadjusted averages weighted by enrollment, reductions in medical claims relative to the comparison group were about 3 percent larger than incentive payments across the different ACO cohorts (Song 2020).

Following are the key findings from the AQC evaluation:

- The AQC was not associated with a reduction in inpatient services.
- The AQC was associated with a reduction in “laboratory testing, certain imaging tests, and emergency department visits.”
- The AQC was associated with patients using lower priced sites of care, with approximately 29 percent

(continued next page)

will be shared among the whole organization. Finally, even if a hospital has an incentive to reduce volume, the hospital administrators may be reluctant to make the difficult decisions to reduce the size of their organization. In general, reducing an organization's growth is, by nature, counterintuitive and may not be rewarded by the hospital's board.

While historically, ACOs in one-sided models received only 50 percent of shared savings, CMS has moved toward giving hospitals in ACOs larger incentives to reduce hospital volume. Under two-sided models, shared savings rates rose to 75 percent in the enhanced MSSP model, 80 percent in the Next Generation (NextGen) model, and are proposed to go up to 100 percent shared savings in the Direct Contracting model. To the extent that the problem is a lack of institutional incentive, 100 percent shared savings could help solve the problem.

In addition to institutional incentive issues, the hospital's culture may still be influenced by payments for non-ACO Medicare beneficiaries and commercial patients for whom the hospital receives FFS payments. One notable exception is Maryland, where hospitals have had an all-payer global budget since 2014. This payment model reduces the issue of mixed incentives. However, a recent analysis of Maryland's hospital global budget model suggests that although inpatient use was reduced, it was not clear that net Medicare spending was reduced (Haber et al. 2018, Roberts et al. 2018). In addition, Maryland is unique in that the level of Medicare payments under the global budget is far higher than what Medicare payments would have been under traditional FFS rates. Expanding the Maryland model to other states would be difficult, and it is not clear that overall spending would decline, given the high level of spending in Maryland and the lack of clear findings on changes in Maryland's overall Medicare spending.

Savings from commercial ACOs may be difficult to replicate in Medicare ACOs (cont.)

of savings resulting from using lower priced services rather than fewer services.

- For most ACO cohorts, the savings from reduced service use began to exceed the incentive payments provided to the ACO in the later years.
- Quality of care process measures improved as did outcome measures for hypertension and diabetics' control of glycated hemoglobin.
- A study of differences in AQC performance among lower and higher socioeconomic status groups found: "Quality improved for all enrollees in the Alternative Quality Contract after their provider organizations entered the contract. Process measures improved 1.2 percentage points per year more among enrollees in areas with lower socioeconomic status than among those in areas with higher socioeconomic status. Outcome measure improvement was no different between the subgroups; neither were changes in spending" (Song et al. 2017).

While the results from the AQC are promising, Song and colleagues warned that they may not be generalizable for other ACO arrangements such as Medicare because 29 percent of the AQC savings in early years resulted from using lower cost providers (a price effect) rather than using fewer services (a quantity effect). For example, savings could occur when volume shifts from a higher priced hospital to a lower priced hospital. Similar savings may be more difficult to achieve in Medicare in part because Medicare sets prices administratively. In addition, some have noted that the model is more easily implemented with an HMO population than in more open coverage arrangements, such as preferred provider organizations (PPOs) or Medicare ACOs. In 2016, the AQC expanded to include Massachusetts's BCBS PPO members, and providers have continued to accept two-sided risk for both HMO and PPO members under these contracts. A formal evaluation of results in the PPO context, similar to the evaluation conducted on the HMO model, is under way. ■

Increasing specialist engagement with ACOs

Some stakeholders contend that ACOs need to meaningfully engage specialists in efforts to practice conservatively. Several factors can influence specialists' participation in ACOs, such as the potential to increase their referrals from the ACO's primary care physicians, to share in savings if the ACO reduces spending below its benchmark, and to receive a 5 percent incentive payment from Medicare if the ACO qualifies as an advanced alternative payment model (A-APM) (clinicians with substantial participation in an A-APM receive a payment worth 5 percent of their professional services payments in a lump sum from 2019 through 2024).²

ACOs might want to include specialists as participating physicians because, through incentives, they can influence specialists to practice conservatively and avoid unnecessary services. However, ACOs may not see a need to include specialists because beneficiaries are

mainly assigned to ACOs based on their primary care visits with primary care clinicians. Even if specialists do not participate in an ACO, the ACO can still influence specialists' practice patterns if the ACO's primary care physicians influence referrals to specialists.

Interviews with ACO leaders and focus groups with physicians provide insights into whether ACOs seek to include specialists and how these organizations manage the use of specialty services. These findings come from two sources: (1) interviews that Commission staff conducted in 2018 with leaders of 17 ACOs in 3 states that were participating in the MSSP and NextGen programs and (2) focus groups conducted by Commission staff in 2019 with physicians in markets that have Medicare ACOs.³

Among the ACOs we interviewed, the share of participating specialists varied widely. ACOs led by primary care physician groups may be more selective about their participating physicians than other ACOs and

may not include any specialists, but many of the health system–affiliated ACOs (and one led by a multispecialty group practice) include more specialists than primary care physicians. Health system–affiliated ACOs tend to include all their employed physicians in their organization, which might explain why these ACOs have more specialists than primary care physicians. ACOs that include specialists told us that participating specialists may be less aware than primary care physicians that they are part of an ACO. According to the physician focus groups we conducted, specialists who participate in an ACO may or may not receive a bonus when their ACO produces shared savings. Some specialists felt frustrated that they were not financially rewarded when their ACO reduced spending.

The ACOs interviewed said they use various approaches to manage referrals to specialists. One technique is to encourage primary care clinicians to refer patients to lower cost specialists. For example, one ACO gives its primary care physicians data on how specialists are ranked based on their use of services. According to ACOs, when specialists know that information on their cost and use of services will be shared with primary care clinicians, it gives specialists a strong incentive to change their behavior. Another tool to reduce the cost of specialty care is to give specialists information about their service use (e.g., the number of tests, procedures, and follow-up visits).

Our analysis of physician participation in ACOs found that the share of specialists participating in MSSP and NextGen ACOs in 2018 was similar to the share of specialists among all physicians participating in Medicare. Of physicians participating in MSSP ACOs and NextGen ACOs, specialists accounted for 63 percent and 60 percent, respectively. By comparison, in 2018, 64 percent of all physicians participating in Medicare were specialists. The share of specialists is generally higher in hospital-affiliated ACOs than physician-led ACOs. Among MSSP ACOs in 2018, 65 percent of physicians in hospital-affiliated ACOs were specialists, compared with 50 percent of physicians in physician-led ACOs. The gap is larger among NextGen ACOs: In 2018, in hospital-affiliated ACOs, 63 percent of physicians were specialists, compared with 36 percent in physician-led ACOs. One explanation for the higher share of specialists in hospital-affiliated ACOs could be that these types of ACOs tend to include all of a hospital's employed physicians.

To explore whether MSSP ACOs that earn shared savings share the savings with specialists, we looked at public

websites for a sample of 200 MSSP ACOs from the 2018 performance year. Of those ACOs, 69 (35 percent) had easily searchable websites that listed how they distributed shared savings. On average, those ACOs distributed 58 percent of their savings to providers, although the share distributed to providers varied widely. The remaining ACOs' shared savings went to administration and infrastructure. Only eight ACOs reported how they distributed shared savings among provider types. Six ACOs distributed 60 percent of their shared savings to providers, all of which went to primary care clinicians. One ACO reported that, of the 75 percent of shared savings distributed to providers, 60 percent went to physicians (whether the physicians were primary care physicians or specialists was not specified) and 40 percent went to hospitals. Another ACO reported that it distributed 70 percent of its shared savings to providers; 60 percent went to primary care physicians, 35 percent to specialists, and 5 percent to hospitals.

Although few studies examine the impact of specialists' participation in ACOs on volume and spending, one study found that MSSP ACOs with a high share of primary care physicians were more likely to reduce the number of visits with specialists than ACOs with a high share of specialists (Barnett and McWilliams 2018). These results are consistent with the authors' hypothesis that ACOs with more primary care physicians have a stronger incentive than other ACOs to reduce the use of specialty care because they do not lose FFS revenue when they provide less specialty care. Another study found that independent primary care group ACOs in the MSSP reduced total Medicare spending but independent multispecialty group ACOs did not (McWilliams et al. 2016a, McWilliams et al. 2016b).

Challenges in bringing Part D drug spending into ACO benchmarks

Medicare ACOs are held accountable only for the cost of Part A and Part B services. Notably absent are the costs of outpatient prescription drug spending, even though ACO clinicians directly prescribe medications for their patients.

Despite the important role pharmaceuticals play in treating many conditions, Part D, Medicare's program for outpatient drugs, operates separately from Part A and Part B. Not all beneficiaries in FFS Medicare enroll in Part D, but those who do are enrolled in one of the typically dozens of privately run stand-alone prescription drug plans (PDPs) that operate in their geographic region, and they can change their enrollment decision annually.

Plan sponsors that operate PDPs usually have no direct relationship with prescribers. PDPs must provide access to a broad set of drugs most commonly needed by enrollees as recognized in national treatment guidelines, but the specific medicines included on each plan's formulary or drugs that are assigned preferred cost sharing vary. Part D's payment and enrollment systems are distinct from those of FFS Medicare, and although PDP sponsors bear financial risk for prescription drug spending, they are not at risk for medical spending.

Unlike Medicare ACOs, formal integration of medical and drug spending is common among ACOs with commercial contracts. According to one national survey of ACO executives conducted between 2012 and 2014, 76 percent of ACOs that had at least one commercial contract were held responsible for drug costs in their largest contract (Colla et al. 2015).

Approaches toward integrating medical and drug services

Increased alignment of ACOs and Part D has the potential to create a more comprehensive approach to improving the efficiency of care delivery. However, carrying out such integration would be complex. For example, CMS could include Part D spending in ACO benchmarks without formal collaboration between ACOs and PDPs. Alternatively, CMS could encourage Part D plans to contract with ACOs to reduce drug spending. Both approaches are challenging.

Approach 1: Add Part D spending to the ACO benchmark

Under the first approach, CMS would use past Part D claims for each ACO assignee to project a drug spending benchmark to add to the ACO's Part A and Part B benchmark. ACOs would have the opportunity to share savings if actual spending for combined medical and drug benefits were lower than the projected benchmark. The approach has advantages, notably giving ACOs stronger incentives to evaluate prescription use and spending in their decision-making. However, not every FFS beneficiary chooses to enroll in Part D, so CMS would not have drug claims for all ACO assignees to add to benchmarks. Because Medicare already holds PDPs accountable for some Part D spending through capitated payments, this approach of adding drug spending to the ACO benchmark would separately compensate two sets of providers (PDPs and ACOs) for bearing the same risk. In addition, projecting Part D benchmarks would be difficult. The agency would need to develop methods to attribute

rebates and discounts to individual beneficiaries to reflect their historical net drug spending, and then project forward expected future rebates. A further problem is that this model would not integrate ACO and PDP providers' decision-making regarding formularies and benefit design.

Approach 2: Encourage ACOs to contract with Part D plans

Under a second approach, CMS would encourage and support private collaboration between ACOs and PDPs. In recent years, Medicare ACOs have built partnerships with a number of entities related to prescription drug spending, including PDP sponsors such as CVS Caremark and pharmacy chains such as Walgreens. While they have had mixed success, the general goals of these collaborations include filling gaps in care (e.g., administering flu shots), sharing data, and helping to set targets for and monitor prescription drug adherence. In 2014, SilverScript, CVS Caremark's (now CVS Health) brand of stand-alone Part D plans, announced that it was entering into a shared savings arrangement with several ACOs to lower Part D drug spending for its enrollees (Avalere Health 2014).⁴ The arrangement provided ACO partners with financial incentives to reduce drug spending through one-sided shared savings for Part D costs. According to the announcement, SilverScript would benefit only from lower drug spending, not from lower FFS spending, even if those savings were a consequence of improved medication adherence. SilverScript's collaborations with ACOs appear to have continued at least through 2017 (Brennan 2017). CVS Caremark continues to promote its potential role in improving health outcomes and lowering costs by leveraging its data and the ability to screen for evidence of nonadherence or safety concerns. CVS Caremark's enthusiasm for ACO collaborations suggests that SilverScript reaped some benefits through these partnerships. However, there are currently no published studies on how effective SilverScript's ACO collaboration has been. To the extent that this model works, there may be little for CMS to do other than facilitate the exchange of information.

Potential for unwarranted shared savings from patient selection

Because Medicare savings from MSSP ACOs have been modest thus far (although still greater than most care coordination demonstrations), those savings need to be protected from unwarranted shared savings payments to

Beneficiary assignment in the MSSP

In the Medicare Shared Savings Program (MSSP), beneficiaries are assigned to MSSP accountable care organizations (ACOs) in a multistep process, as shown in Figure 2-1.

In general, the claims history of beneficiaries who are eligible for ACO assignment is reviewed. Beneficiaries are eligible for assignment if they meet certain criteria, including having been in Part A and Part B of Medicare

(continued next page)

FIGURE 2-1

ACO assignment in the Medicare Shared Savings Program

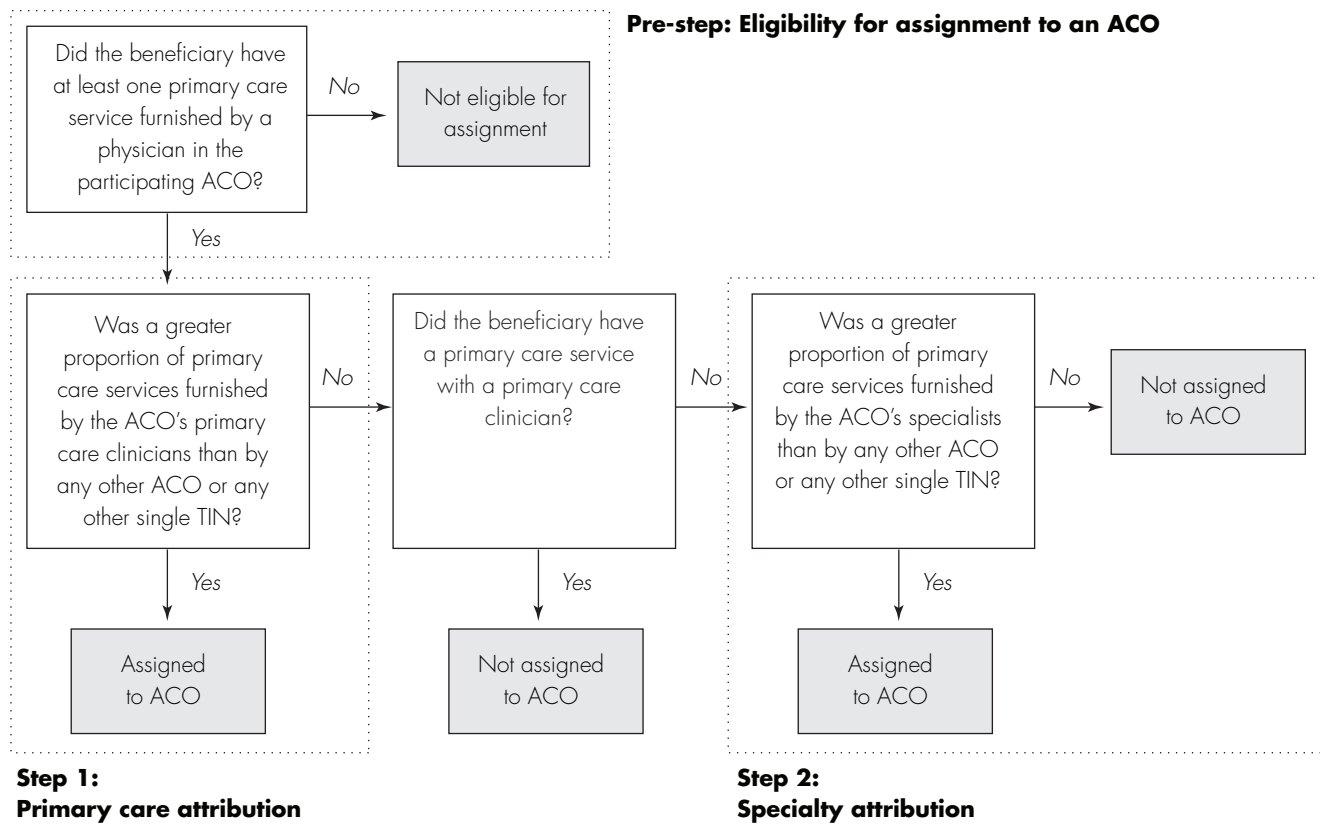

Note: ACO (accountable care organization), TIN (taxpayer identification number). According to regulations found in 42 CFR §425.20, an ACO is identified by a Medicare-enrolled TIN that alone or together with one or more other ACO participants constitutes the ACO. The proportion of primary care services is measured by Medicare-allowed charges. Specialty attribution occurs only for beneficiaries who did not have a primary care service with a primary care clinician but did have a service with an ACO specialist.

Source: Centers for Medicare & Medicaid Services. Financial and beneficiary assignment specifications Versions 3-6. <https://www.cms.gov/Medicare/Medicare-Fee-for-Service-Payment/sharedsavingsprogram/program-guidance-and-specifications.html>.

ACOs. There will always be some unwarranted shared savings payments due to random variation, but there could also be unwarranted shared savings payments due to intentional favorable patient selection. For example, if high-cost beneficiaries are disproportionately shifted

out of an ACO in the performance year—but not in the baseline years—performance-year spending will decrease in relation to the ACO's benchmark, which could result in unwarranted shared savings.

Beneficiary assignment in the MSSP (cont.)

for 12 months (so that they have a claims history) and not having been enrolled in Medicare Advantage during that time.

To be assigned to an MSSP ACO, a beneficiary must have at least one primary care service furnished by a physician in the participating ACO. Services are designated primary care services by regulation and must be furnished by an ACO physician in certain

specialties (e.g., family practice, internal medicine, cardiology, endocrinology, gynecology, nephrology, psychiatry, and oncology) but not by a nonphysician. Visits with primary care physicians take precedence in assignment. (More detail on definitions of primary care services and ACO physicians and nonphysicians can be found in online-only Appendix 6-A to the Commission's June 2019 report, available at <http://www.medpac.gov>.) ■

Under Medicare billing rules, providers bill Medicare using taxpayer identification numbers (TINs). TINs can be used to identify the source of Medicare's billings; CMS uses TINs to identify the billings that are associated with each ACO. However, TINs are not unique to each clinician. Rather, a single TIN can comprise a sole physician in one office or a multistate integrated delivery system with many clinicians. Favorable selection of physicians could occur if an ACO stopped providers with high-cost beneficiaries from billing under the ACO's TINs and had those providers bill under a non-ACO TIN. Selection could also occur if an ACO removed just a portion of a high-cost provider's patients from the ACO. The provider could bill for patients with low spending under the ACO's TINs and bill for patients with higher spending relative to their risk score under a non-ACO TIN. While we do not have evidence of widespread patient selection at this time, we did find evidence that ACOs with large shared savings payments benefited from disproportionately high-cost patients being assigned out of their ACO.

An alternative to removing high-cost patients from the ACO would be to retain low-cost patients in the ACO. ACOs appear to achieve this objective through the use of wellness visits. Whether the wellness visits are designed to retain low-cost patients, to improve quality metrics, or to better manage care, the data suggest they result in ACOs achieving a favorable selection of patients, at least when retrospective assignment is used.

ACOs appear to have generated savings for the Medicare program. However, a future risk of provider and patient selection remains. This type of selection can become more problematic if CMS does not address vulnerabilities in the

current system for assigning physicians and beneficiaries to ACOs. Even if a minority of ACOs engage in selection activities, it could diminish the program's ability to generate Medicare program savings in total. For that reason, we investigate how to make the ACO assignment mechanism less susceptible to mismatches between providers' patient spending history used to set spending benchmarks and providers' actual patient spending used to compute ACO spending in performance years.

Use of TINs for assignment in the MSSP raises concerns

To compute MSSP shared savings and losses, CMS compares actual spending for beneficiaries assigned to an ACO with a benchmark that estimates what spending was expected to be for those beneficiaries. To protect both the Medicare program and ACO participants, ACO benchmarks should be computed in a way that most accurately reflects the health care needs of the beneficiaries assigned to an ACO.

Beneficiaries are assigned to an ACO based on a list of TINs that an ACO annually submits to CMS; this collection of TINs represents the clinicians who will be the ACO's participants for the performance year.⁵ As noted above, a single TIN can range from a sole physician in one office to a multistate integrated delivery system with many clinicians (each individual clinician does have a unique national provider identifier (NPI)). To determine the beneficiaries assigned to an ACO, CMS follows a multistep process described in the text box on beneficiary assignment in the MSSP. In short, claims for each beneficiary are grouped by TINs, and if the ACO (defined as a collection

of TINs) provides the plurality of primary care for the beneficiary compared with any other ACO or individual TIN, the beneficiary is assigned to that ACO.

CMS computes an ACO's spending in the baseline years (i.e., the three years before the ACO's first performance year of its MSSP contract) and combines them to create the historical portion of the benchmark.⁶ That historical spending and regional spending are then blended and trended to the performance year to compute the benchmark against which spending in the performance year will be compared. To establish the historical portion of an ACO's benchmark, CMS computes an ACO's historical spending based on the beneficiaries who would have been assigned to the ACO in the ACO's baseline years. Assignment in the baseline years uses the same list of TINs submitted by the ACO for the performance year and uses the same claims-based multistep assignment process shown in Figure 2-1 (p. 26).⁷ (Between baseline and performance years, assigned beneficiaries are not fixed, but TINs are fixed.)

However, the NPIs associated with an ACO's TINs are not fixed—creating a potential mismatch in the calculation of ACO benchmarks. Mismatches of ACO TIN clinicians can occur when NPIs are removed from a TIN, added to a TIN, or associated with more than one TIN—including TINs in a different ACO and TINs outside of an ACO.⁸ We examined the removal of individual primary care physicians (PCPs) (as specified by their NPIs) from TINs participating in the same ACO in 2016 and 2017.⁹ Among the nearly 103,000 TIN–NPI combinations of PCPs in 2016, 7 percent were removed from ACOs in 2017. TIN-level historical benchmarks did not capture the removal of PCPs from these TINs.¹⁰ We also examined the PCP NPIs added to TINs participating in the same ACO in 2016 and 2017. Among TIN–NPI combinations of PCPs in the MSSP in 2017, 29 percent were added to ACO TINs from the previous year. These PCPs were not participants under any of the ACOs' other TINs in 2016. The NPI removals from and additions to TINs capture only the mismatch in TIN clinicians between 2016 and 2017. There was likely a greater mismatch of TIN clinicians between ACOs' performance year and baseline years, which would have spanned at least four years (the performance year and three baseline years). If ACOs manipulate these mismatches to increase the likelihood of receiving shared savings payments without lowering their growth in spending (or avoiding shared losses when increases in spending growth occur), the result creates vulnerabilities in the MSSP.

Three vulnerabilities

The reliance on TINs to compute the benchmark against which an ACO's financial performance is measured creates three vulnerabilities that could result in unwarranted shared savings.

Clinicians removed from TINs One vulnerability is that an ACO's historical benchmark (based on TINs) is not adjusted when clinicians (and their patients) are removed from its TINs in later years. An ACO could unjustifiably receive “shared savings” by removing high-cost providers from TINs in the ACO. The beneficiaries who would have been assigned to those high-cost providers would remain in an ACO's benchmark but would be removed from the ACO's performance-year spending. The illustration in Figure 2-2 shows this vulnerability in hypothetical ACOs. Before the performance year, ACO₂ removes NPI₅, who has beneficiaries with relatively high spending, from participant TIN_D. The high cost of NPI₅ continues to be in ACO₂'s baseline, which is used to calculate the ACO's benchmark. However, the ACO is not liable for NPI₅ in its performance year, leading to unwarranted shared savings.

The hypothetical example in Figure 2-2 illustrates how the assignment algorithm is vulnerable to shifting the TINs under which NPIs bill. See the text box on anomalous results using TINs (pp. 30–31) for an example of how the current assignment mechanism using TINs could have contributed to some of the anomalous shared savings payments that have been made.

Clinicians added to TINs A second vulnerability resulting from TIN-level benchmarks can occur when providers are added to TINs. In this case, the benchmark may not reflect the historical claims of those providers. In particular, primary care physicians could be added under TINs with which they have no historical claims data (that is, in the baseline years, they billed under a different TIN). An ACO could receive unwarranted shared savings by adding low-cost providers who previously billed Medicare using TINs outside of the ACO's current participant list. The low-cost providers' claims would not be included in the ACO's benchmark calculation but would be included in the ACO's performance-year spending.

Billing high-cost patients under non-ACO TINs A third vulnerability resulting from the use of TIN-level benchmarks is that providers can opt to bill high-cost patients under TINs outside of the ACO's participant list, through referrals or through directly billing to a separate

FIGURE 2-2

Illustrative example of selection resulting from changing the TIN under which an NPI bills

Baseline ACO-TIN configuration used for ACO benchmarks

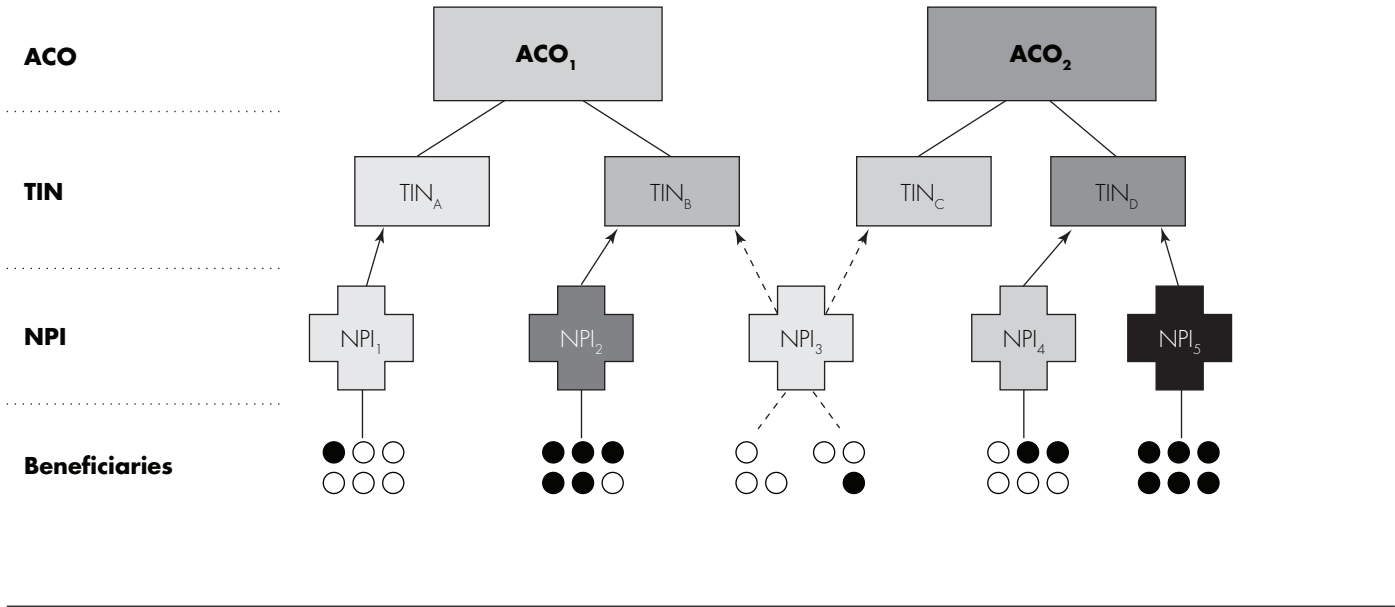

Performance-year ACO-TIN configuration

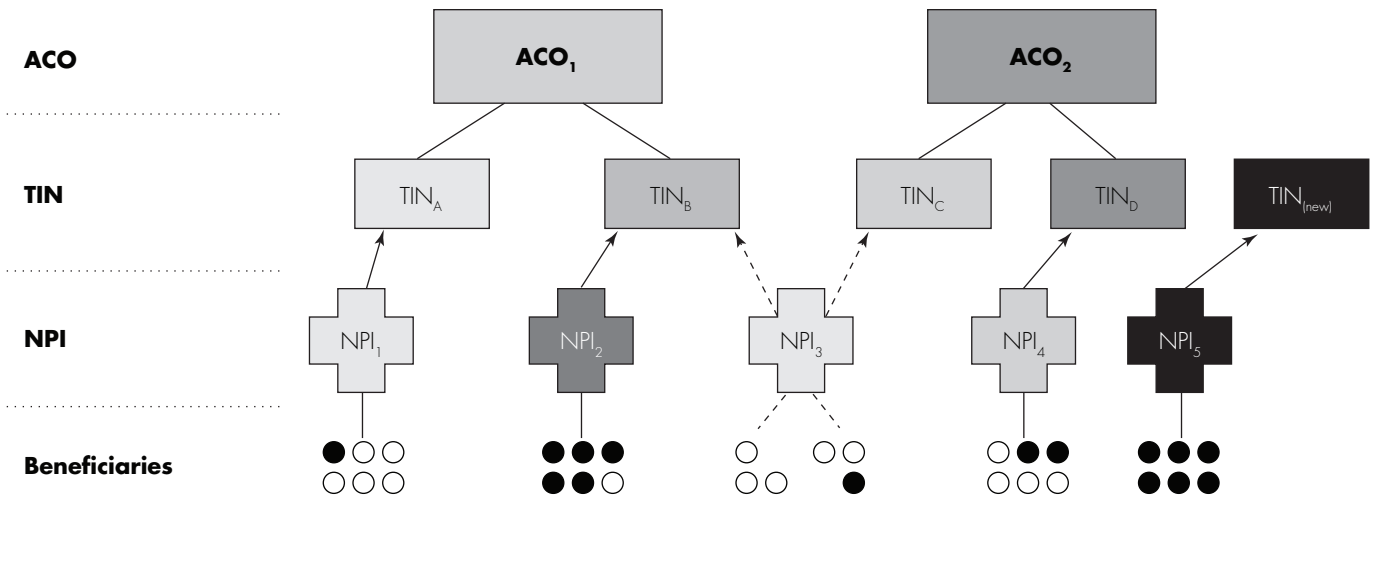

Note: ACO (accountable care organization), NPI (national provider identifier), TIN (taxpayer identification number). Each dot represents 1,000 beneficiaries. Black dots represent beneficiaries with relatively high spending; white dots represent relatively low-spending beneficiaries. Lines connect beneficiaries to the NPIs through which their ACO assignment is determined.

Source: MedPAC analysis of Medicare Shared Savings Program assignment algorithm.

Example of anomalous results using identification of ACO participants at the level of taxpayer identification numbers

To illustrate how the movement of providers' national provider identifiers (NPIs) in and out of an accountable care organization's (ACO's) taxpayer identification numbers (TINs) can be associated with anomalous results, we look at an ACO that had large savings relative to its benchmarks in 2016, 2017, and 2018 (Table 2-2). This ACO also exhibited a great deal of volatility in its roster of participating clinicians and the risk profile of its beneficiaries. There is a notable change

in the number and mix of clinicians in the ACO between 2015 and 2016. In those years, the number of primary care physicians declined from 265 to 154, and the number of specialists declined much more, from 565 to 103. This dramatic change in clinicians coincided with the renewal of the ACO's Medicare Shared Savings Program (MSSP) contract. The new contract recalculated the ACO's benchmarks based on beneficiaries assigned to the ACO's TINs from 2013 through 2015.

(continued next page)

**TABLE
2-2**

Example of an ACO with volatile enrollment and clinician participation

	2015	2016	2017	2018
PCPs	265	154	187	240
Specialists	565	103	125	154
Nonphysician providers	89	81	244	294
Assigned beneficiaries	8,597	6,051	5,742	5,451
Risk score	1.35	1.10	1.07	1.06
Benchmark per capita	\$19,859	\$20,720	\$23,181	\$22,929
Spending	\$22,987	\$15,836	\$16,262	\$15,800
Difference	-\$3,127	\$4,884	\$6,919	\$7,130

Note: ACO (accountable care organization), PCP (primary care physician). Shared savings are calculated as a percentage of the difference between the ACO's benchmark and spending. Components may not sum to totals due to rounding.

Source: MedPAC analysis of CMS Medicare Shared Savings public use files.

TIN. At least one ACO reported creating a separate TIN for physicians serving certain high-cost patients to avoid having those patients assigned to the ACO (RAND Corporation 2018). Under these scenarios, more high-cost beneficiaries would be assigned to an ACO's historical benchmark—before providers billed high-cost beneficiaries outside the ACO's TINs—compared with the ACO's performance year.

Use of TIN–NPI combinations for assignment has shortcomings

In the NextGen and Direct Contracting demonstrations, providers are identified at the TIN–NPI level rather than at the TIN level. That approach avoids the problem of the TIN-based benchmarks staying constant even if clinicians are removed. However, benchmarks based on TIN–NPI combinations remain vulnerable to inaccuracies if PCPs are added to ACO TINs. In addition, unlike TIN-based

Example of anomalous results using identification of ACO participants at the level of taxpayer identification numbers (cont.)

At the same time, the number of assigned beneficiaries changed as well, with a 30 percent drop from 2015 to 2016. Many of those beneficiaries had likely been assigned to the ACO through the providers who left. This drop was accompanied by a change in the average risk score for the beneficiaries in the ACO. Between 2015 and 2016, the average risk score dropped from 1.35 to 1.10 and then leveled off in 2017 and 2018.

The 2016 drop in risk score did not correspond with a decrease in the benchmark because the historical spending of beneficiaries assigned to the ACOs TINs did not decrease. The remaining physicians belonged

to TINs with historically high spending and risk scores (from 2013 to 2015) relative to the ACO's performance years (from 2016 to 2018). As a result, the ACO's spending compared with its benchmark switched from being substantially greater than the benchmark in 2015 to being substantially below the benchmark in 2016, 2017, and 2018 (\$4,884 per capita, \$6,919 per capita, and \$7,130 per capita, respectively). After collecting over \$35 million in shared savings from 2016 to 2018, this ACO discontinued its MSSP participation in 2019—when benchmarks would have been based on historical spending from 2016 to 2018. ■

benchmarks, TIN–NPI combination benchmarking would be vulnerable to unwarranted shared savings when an ACO moves an NPI between two of its TINs. In this scenario, an NPI could have spending under one of the ACO's TINs in the baseline years, but that spending would not be captured in the benchmark if the NPI began billing under a new TIN within the same ACO during the performance year. Under TIN–NPI benchmarking, an ACO could unjustifiably receive shared savings by moving low-cost providers between two of its TINs. The low-cost providers would not be in the ACO's benchmark but would be included in the ACO's performance year spending. In the NextGen demonstration, the substantial changing of TIN–NPI combinations between the first and second year of the program prompted methodological changes to how CMS's contractor evaluated the second year of the program. To evaluate quality and spending relative to a comparison group, the evaluator of the NextGen ACO demonstration in its most recent evaluation used NPI-only assignment to create a better match between baseline-year beneficiaries and an ACO's performance-year beneficiaries (NORC at the University of Chicago 2020).

Opportunities to select healthy patients

The savings achieved by ACOs for the program thus far (1 percent or 2 percent) could be vulnerable if ACOs can engage in patient selection that is not reflected in their

benchmarks and subsequently leads to unwarranted shared savings payments. This benchmarking problem could result from having low-cost patients enter into the ACO without changing the benchmark or having high-cost patients exit the ACO without changing the benchmark. We have not seen evidence of pervasive selection thus far, but we are concerned about the incentives as ACO experience matures and shared savings become more reliant on risk adjustment and regional spending.¹¹

One strategy is to use annual wellness visits (AWVs) for assigning patients to an ACO. Patients who have AWVs are generally low cost in the year of the visit. This strategy is easier to pursue under a system of retrospective assignment rather than prospective assignment. Retrospective assignment is technically known as preliminary prospective assignment with retrospective reconciliation. It is also sometimes referred to as concurrent assignment. In its MSSP assignment specifications, CMS most commonly uses the term *retrospective assignment*.

A review of retrospective and prospective assignment

As described earlier, beneficiaries are assigned to an ACO based on which ACO provided the plurality of their qualifying primary care services. Assignment can be based

Retrospective and prospective assignment of beneficiaries to accountable care organizations

To illustrate the difference between prospective and retrospective assignment, the first two figures show an example of a patient assigned to an accountable care organization (ACO) based on a single primary care visit to an ACO primary care physician on July 1, 2019, under first retrospective and then prospective assignment. As Figure 2-3 shows, under retrospective assignment, the ACO would be responsible for all spending that occurs in 2019, including the six months before the July 1 visit and the six months after the visit, and could include care from non-ACO clinicians in 2019.

Figure 2-4, by contrast, uses the same example of a patient assigned to an ACO based on a single primary care visit to an ACO primary care physician on July 1, 2019, to show that under prospective assignment, the ACO would be responsible for all spending in 2020 (for all applicable months that the beneficiary was in fee-for-service Medicare). All of that care would occur after seeing an ACO clinician, and it could include care from non-ACO clinicians in 2020.

(continued next page)

**FIGURE
2-3**

Performance period under retrospective assignment

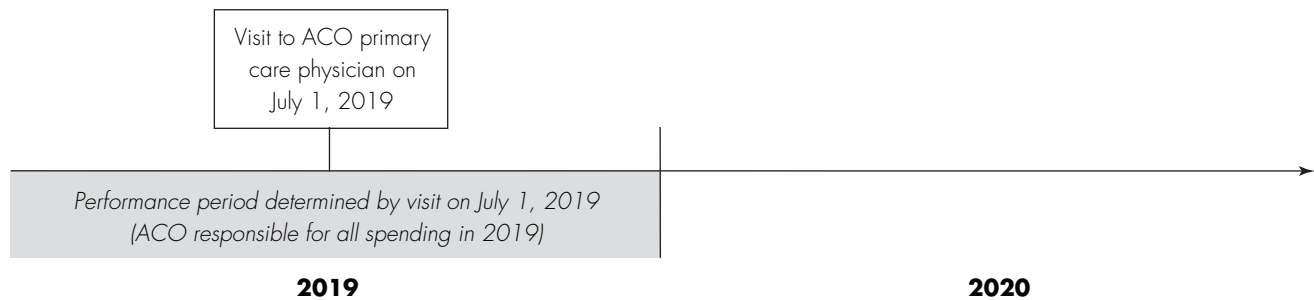

Note: ACO (accountable care organization).

on as little as one primary care visit with a physician. Different ACO programs have different rules about which primary care services determine assignment. Most ACOs in the MSSP have used retrospective assignment. Under this approach, a beneficiary is preliminarily assigned to an ACO based on primary care visits during the prior year (e.g., 2018), but the final assignment is determined retrospectively by examining the plurality of primary care visits during the performance year (e.g., 2019). The list of preliminarily assigned beneficiaries will differ from the list of finally assigned beneficiaries to the extent that patients switch clinicians over the two-year period. The difference in assignment lists can be substantial. For example, in

2017, 21 percent of beneficiaries assigned to an ACO preliminarily were not assigned at the end of the year, and 27 percent of those assigned finally were not on the preliminary assignment list.¹²

Under prospective assignment (as used in the NextGen ACO model), beneficiaries' final assignment is made based on their primary care visits during the fiscal year before the performance year.¹³ In other words, under prospective assignment, ACOs know with almost certainty which beneficiaries they are responsible for at the start of the year. By contrast, in retrospective assignment, an ACO ends up responsible for many beneficiaries whom the ACO will not know it is responsible for until well into

Retrospective and prospective assignment of beneficiaries to accountable care organizations (cont.)

If patients see the same primary care physician over multiple years, prospective and retrospective assignment will not differ. However, which assignment mechanism is used has substantial assignment implications for beneficiaries who switch primary care providers from one year to the next. On the one hand, one could argue that it makes sense in the example for the ACO under retrospective assignment to have responsibility for 2019 spending because an ACO physician saw the patient in 2019 and would have some influence over his or her care in the last half of the year. On the other hand, the patient could have had high

spending before July 1, 2019, and it would be unfair for the ACO to be accountable for spending that occurred before ever seeing the patient.

Under prospective assignment, in which the ACO is responsible for 2020 spending, one could argue that the ACO should have at least a small influence over 2020 spending because it will occur after an ACO physician has seen the patient, and the ACO will receive updates on the beneficiary's health status and medical services received in 2020, even if the beneficiary switches to a physician outside of the ACO.

(continued next page)

**FIGURE
2-4**

Performance period under prospective assignment

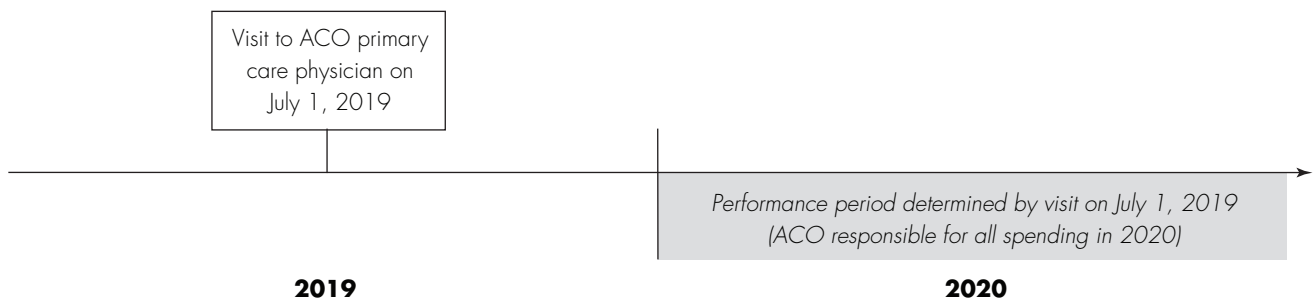

Note: ACO (accountable care organization).

the performance year, and the ACO will lose a share of patients it thought it would be responsible for, but is not. The text box on retrospective and prospective assignment (pp. 32–35) illustrates the mechanics of these approaches.

Opportunities to use wellness visits to retain low-spending beneficiaries in ACOs

While patient selection did not appear to have a significant net effect on shared savings in the initial years of the program, patient selection could represent a vulnerability for the ACO program going forward. We first consider

the potential for selection of low-spending beneficiaries in ACOs through AWVs. Currently, ACOs use AWVs more than traditional FFS, AWV patients at their initial AWV tend to have had lower historical spending than other patients, and AWVs have not resulted in Medicare savings. Second, we consider the possibilities for selection against high-spending beneficiaries. The selection of beneficiaries based on their spending patterns could result in unwarranted shared savings payments to ACOs.

Our June 2019 report explored ACOs' use of AWVs and described how AWVs could result in a favorable

Retrospective and prospective assignment of beneficiaries to accountable care organizations (cont.)

Under both retrospective and prospective assignment, the ACO of the physician who saw the patient in the prior year should receive updates on the patient’s health status, up until three months after the patient starts to see another physician. In a hypothetical example shown in Figure 2-5, a beneficiary received a September 1, 2019, visit with a primary care provider (PCP) who participates in ACO 1. The patient then has a hospital admission in February 2020 followed by a primary care visit on July 1, 2020, with a different PCP, who participates in ACO 2. In this example, under prospective assignment, ACO 1 would have responsibility for the beneficiary’s spending in 2020. Under retrospective assignment, ACO 2 would have

responsibility for the beneficiary’s spending in 2020. In both cases, the performance year in question is 2020.

Given this illustrative example of the timing of physician visits, we contrast the Medicare Shared Savings Program’s retrospective assignment and information flow with Next Generation ACOs’ fully prospective assignment under this scenario (Table 2-3).

The assignment method used can make a difference in which ACO is responsible for a beneficiary’s spending in a given year. Under prospective assignment, ACO 1 is responsible for Beneficiary A’s spending in 2020; under retrospective assignment, ACO 2 is responsible.

(continued next page)

FIGURE 2-5

Assignment under retrospective and prospective assignment for Beneficiary A

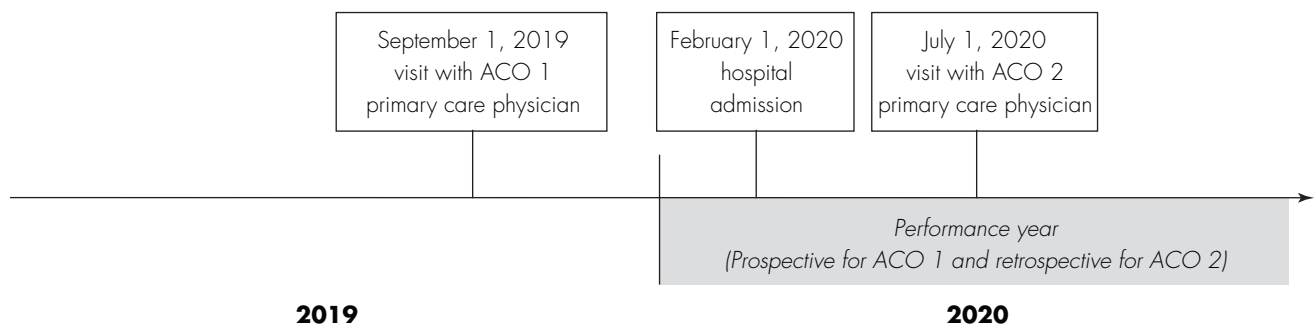

Note: ACO (accountable care organization).

selection of patients. While ACOs’ motivation for AWVs could be care coordination or improvements on MSSP quality metrics (e.g., to document counseling on smoking cessation or screening for clinical depression), they could also result in keeping relatively healthy beneficiaries assigned to the ACO and receiving higher risk scores from the health risk assessments performed during the wellness visit. In a study of motivations for AWVs, ACOs mentioned patient care needs, performance on quality metrics, assignment, revenue, and Medicare’s

hierarchical condition category (HCC) coding of patients (Briggs et al. 2019). However, the study did not find any better performance on cost or quality among ACOs using AWVs as a care management strategy. In addition, the Commission has noted the use of health risk assessments—an essential element of AWVs—to increase HCC scores and has recommended that diagnoses stemming only from these services be excluded from risk score calculations both in FFS and in MA (Medicare Payment Advisory Commission 2016).

Retrospective and prospective assignment of beneficiaries to accountable care organizations (cont.)

There are advantages to prospective assignment. First, under prospective assignment, the ACO that receives information on the patient’s health status and health care services at the start of the year will be the ACO responsible at the end of the year. This approach (which mirrors the Medicare Advantage approach) makes population health analytics easier (Table 2-3). Second, prospective assignment makes it easier to construct algorithms to work with other payment policies. For

example, to avoid paying twice for the same savings, CMS would want to know at the beginning of the year whether a patient is in an ACO and not allow that patient to be in a bundled payment initiative in the same year. Making this determination requires prospective assignment so that whether the patient is in an ACO is known with certainty. (An ACO could still initiate its own bundled payment initiative with physicians if it wanted.) ■

**TABLE
2-3**

Information flow under prospective and retrospective assignment

	Under prospective assignment (e.g., NextGen) (Beneficiary A assigned to ACO 1)	Under retrospective reconciliation (e.g., MSSP) (Beneficiary A assigned to ACO 2)
Early January 2020	ACO 1 is told it is responsible for all health care costs in 2020 for Beneficiary A.	ACO 2 receives information on patients it saw in 2019, but receives no information on Beneficiary A because it did not see the beneficiary in 2019.
January	ACO 1 is told about Beneficiary A’s historical spending during 2019.	
February 1	If ACO 1 has a relationship with the hospital, the hospital lets ACO 1 know Beneficiary A was admitted.	
April	ACO 1 is told by CMS that Beneficiary A was admitted to the hospital.	
July 1	ACO 1 is initially unaware of the visit to a PCP in ACO 2.	ACO 2 knows that Beneficiary A was seen by one of its doctors and it may be responsible for all costs during 2020.
October	ACO 1 gets an updated report on all spending in the prior quarter including the visit to the PCP in ACO 2 on July 1.	ACO 2 is told by CMS that Beneficiary A may be assigned to it because ACO 2 has the most 2020 PCP-visit allowed charges. ACO 2 first learns about Beneficiary A’s 2019 and 2020 spending.
January 2021	ACO 1 is held responsible for all Beneficiary A spending during 2020 (despite being assigned on the basis of a visit in September 2019).	ACO 2 is held responsible for all Beneficiary A spending during 2020 (including during the six months before having any information on the patient).

Note: NextGen (Next Generation), ACO (accountable care organization), MSSP (Medicare Shared Savings Program), PCP (primary care physician).

The possibility of AWVs resulting in patient selection is particularly concerning in light of patients' relative health status before receiving their initial AWV. We examined the historical risk scores of patients continuously assigned to the same ACO from 2014 to 2016 who had been eligible for ACO assignment since 2012. We compared patients who received their first AWV in 2015 with those who did not.¹⁴ Although both sets of patients were about the same average age (74 years in January 2015), the average risk score of patients who received their initial AWV was relatively lower before receiving the visit. In addition, patients with wellness visits (particularly in the second half of the year) tended to have relatively low spending in the year of the visit, even after adjusting for risk using HCC scores. This finding implies that beneficiaries who are relatively healthy (even adjusting for risk scores) may be more likely to receive wellness visits compared with beneficiaries who need more resource-intensive care.

Support for AWVs is rooted in the assumption that the visits are important elements of care coordination and early intervention that could lead to reduced future spending. However, a November 2019 study found that AWVs did not result in improvements in care or reductions in Medicare spending in FFS from 2008 to 2015 (Ganguli et al. 2019).

It is possible that some ACOs have leveraged AWVs to improve care coordination and patient outcomes. However, the limited evidence thus far suggests that AWVs have had no overall effect on appropriate screening rates, low-value screening rates, referrals for neuropsychiatric and functional issues, emergency department visit rates, or hospitalization rates (Ganguli et al. 2019). While some suggest that AWVs improve patient satisfaction, our beneficiary focus groups suggest that patients have not found AWVs useful for their own care needs. A number of beneficiaries noted the long list of questions that they were asked to answer. Many said they were given the questions in written form, or even online, to fill out before the visit. Some beneficiaries felt that most of the questions did not apply to them. Beneficiaries who spoke favorably of the AWV did not feel the AWV was personally useful to them but spoke of the visit's potential usefulness to high-risk beneficiaries (e.g., those with dementia, home safety issues, or food security issues).

The lack of evidence that AWVs result in Medicare savings exacerbates concerns about their future impact on patient selection and diagnostic coding. The modest savings that ACOs have achieved thus far may have

resulted from care management methods outside of the AWV (e.g., extended office hours) or from eliminating unnecessary care. If most ACOs continue to outpace non-ACO providers in their use of AWVs without any corresponding savings for Medicare or improvement in patient outcomes, the selection of patients through AWVs—even if unintentional—will be an overall vulnerability to the MSSP and could result in unwarranted shared savings.

Opportunities to select against high-spending beneficiaries in ACOs

As with opportunities to select low-spending beneficiaries, there is the potential for selection against high-spending beneficiaries. To determine this potential, we observed characteristics of high-spending beneficiaries that affected their assignment to ACOs and assessed ways the program could be vulnerable to selection against such beneficiaries.

As discussed in our June 2019 report, the assignment of beneficiaries to ACOs and the loss of their assignment often occurs because of changes in beneficiaries' health status; individuals who change health status tend to have rapidly increasing spending compared with those who are continuously assigned (Medicare Payment Advisory Commission 2019). Beneficiaries whose assignments are changed are more likely to have had a hospitalization and use post-acute care during the year their assignment changed. If assignment entry and exit were consistent in the baseline and performance years, such changes would not be an issue. However, if exit of high-spending beneficiaries increases in the performance year and the difference in spending among beneficiaries continuously assigned and those who lose assignment is large, it could improve an ACO's performance relative to its benchmark and lead to unwarranted shared savings.

Techniques to increase the exit of high-spending beneficiaries could include actions at the ACO level, such as moving clinicians with high-spending patients from the ACO to a different TIN, or actions at the PCP level, such as billing those patients under a TIN outside the ACO or counseling patients to seek care elsewhere (presumably from a colleague or other PCP providing care of a similar quality). We found that the shared savings of individual PCPs could be relatively high—providing a material incentive to adjust backroom operations to improve patient selection. We examined earned "shared savings" for each ACO and divided that bonus payment by the number of the ACO's participating PCPs. We found

that 50 ACOs had earned shared savings per PCP of over \$50,000. (The highest was over \$300,000.) Although these ACOs may have used some of the shared savings for ACO administrative costs or shared them with other clinicians, it appears that some ACOs could have had a material incentive to take actions to select against high-spending patients.

Use of NPI for assignment would improve benchmark validity and reduce unintended incentives

Basing benchmarks directly on the individual NPI claims data of an ACO's participating clinicians would be the most accurate method of validly capturing historical spending for purposes of calculating benchmarks and reducing undesirable incentives. Using NPIs' claims data would improve the comparability of beneficiaries assigned in baseline years to those assigned in performance years—reducing opportunities to manipulate shared savings. Because all of an NPI's applicable claims would be used for beneficiary assignment, providers who would be added to or removed from TINs would not affect NPI assignment. Similarly, NPI assignment would not be affected by providers who changed their TIN billing patterns for particular services or beneficiaries. Consequently, the potentially negative incentives associated with TIN-level assignment do not apply to NPI-based assignment.

Implementation of NPI-based assignment for benchmarks could largely follow the same processes as MSSP's TIN-level assignment in which CMS recalculates benchmarks based on an ACO's most recent participant list. Assignment by NPI rather than TIN would not require any change to an ACO's structure, the relationships that ACO clinicians have with other providers, or the billing arrangements of ACO clinicians. MSSP participant lists would continue to consist of TINs (or CMS certification numbers when applicable), but MSSP historical benchmarks would be based on a collection of NPIs that billed to ACO TINs during the performance-year assignment period. All of an NPI's claims in the ACO's market—irrespective of the TIN—would be included in assignment computations. For purposes of calculating benchmarks and performance-year assignment, each clinician's NPI would be associated with only one ACO. For clinicians who bill under TINs spanning multiple

ACOs, the clinician's longest standing participation in an ACO could take precedence. CMS would remove the clinician's NPI from assignment calculations for all other ACOs. Further, assignment would continue to be based on a beneficiary's plurality of primary care visits (using the collection of NPIs that billed under the ACO's TINs during the performance-year assignment period).

Implementing these changes would require that clinicians' claims be used for assignment to only one ACO (providers could continue to see any FFS beneficiary regardless of that beneficiary's ACO assignment or nonassignment). The MSSP currently allows clinicians (through their NPIs) to be listed as participants under TINs in multiple ACOs.¹⁵ Consequently, clinicians with a disproportionately wide range of TIN billing arrangements could be reluctant to participate in the MSSP. Physicians can see patients from multiple ACOs, but if their claims are being used for assignment, their NPI would be used only to assign patients to a single ACO. However, in 2017, 90 percent of ACO assignment was determined by PCP visits, and 95 percent of these clinicians were assigned to one ACO.¹⁶

One potential concern about using NPI-based benchmarking is that ACOs may have more opportunities to engage in within-practice selection—potentially sending beneficiaries with higher needs to clinicians in the same practice who are not part of the ACO but still bill under the same TIN. However, this issue could be addressed by having MSSP participant lists continue to consist of TINs, and require that all NPIs under a TIN in a performance-year assignment period automatically be designated as ACO participants—limiting opportunities for ACOs to benefit from changing the profile of clinicians' patient panels within a practice. Any changes to the case mix between clinicians under the same TIN during the performance year would not reduce the accuracy of the calculation of ACO spending in the baseline years used for the ACO's benchmark.

A second concern about NPI-level assignment relates to movement of clinicians from one geographic area to another. If the clinician joins an ACO or leaves an ACO midway through the performance-year assignment period, his or her Medicare claims history from outside the ACO's market should not be used to compute the ACO's assignment for the performance or baseline years. Doing so would be problematic if the clinician's non-ACO practice area was one with higher or lower payment rates or utilization rates relative to the ACO's market.

**TABLE
2-4****Methods of defining providers for ACO historical benchmarks**

ACO assignment	Current use	Potential inaccuracies	Unintended incentives
Collection of TINs	MSSP	<p>Providers removed from TINs are not accounted for in historical benchmarks.</p> <p>Benchmarks may not reflect the historical claims of providers added to TINs.</p> <p>Providers can use TINs outside an ACO for high-cost beneficiaries without affecting the benchmark.</p>	<p>An ACO could receive unwarranted shared savings by:</p> <ul style="list-style-type: none"> • Removing high-cost providers from TINs. The high-cost providers would remain in an ACO's benchmark but would be removed from performance-year spending. • Adding low-cost providers who previously used TINs outside the ACO. The low-cost providers would not be in the ACO's benchmark but would be included in performance-year spending. • Using TINs outside the ACO for high-cost beneficiaries. High-cost beneficiaries would disproportionately remain in the ACO's benchmark but would not be included in performance-year spending.
Collection of TIN–NPI combinations	Next Generation ACO Model	Providers added to TINs do not necessarily reflect the historical claims of those providers.	An ACO could unjustifiably receive shared savings by adding low-cost providers to TINs. Claims histories of the low-cost providers would not be included in the ACO's benchmark but would be included in performance-year spending.
Collection of NPIs	N/A	When clinicians move from one geographic area to another, they would bring historical spending from their former area unless those claims were excluded.	Physicians used for assignment would have all their patients assigned to a single ACO, meaning that specialists working with two ACOs would have to choose which ACO to assign their patients to in the rare case that the specialist consultation determines assignment.

Note: ACO (accountable care organization), TIN (taxpayer identification number), MSSP (Medicare Shared Savings Program), NPI (national provider identifier), N/A (not applicable). There is no current use of NPI-level historical benchmarks.

Source: Analysis of MSSP provider data and CMS program rules for benchmark calculations.

For example, if a physician moved from San Francisco to Tulsa, CMS would not want to include historical claims from patients who received most of their care in San Francisco when computing assignment for the Tulsa ACO's benchmarks because claims for San Francisco beneficiaries would reflect higher payment rates and different utilization patterns and thus would be a poor predictor of likely spending for similar patients in Tulsa. To address this problem, CMS would base assignment only on claims from within the ACO's (performance-year) market.

Our findings show that the use of NPI data for benchmarks would reduce the potential for unwarranted shared savings and that under TIN-level definitions, changes in the clinicians who make up an ACO's TINs weaken the utility of historical assignment and benchmarks. Table 2-4 is an abbreviated list of the potential methods of and concerns about defining providers when calculating historical benchmarks.

To address (1) the potential mismatch between the clinicians considered in an ACO's baseline years and its

performance years and (2) the incentives to select low-spending patients and exclude high-spending patients, CMS should use NPIs to identify ACO clinicians' claims for assignment in the performance year and those same clinicians' claims for assignment in the baseline year. Properly matching the clinicians included in an ACO's baseline and performance years will allow a more accurate assessment of an ACO's performance and reduce opportunities for unwarranted shared savings.

RECOMMENDATION 2

The Secretary should use the same set of national provider identifiers to compute both performance-year and baseline assignment for accountable care organizations in the Medicare Shared Savings Program.

The set of NPIs used would be those of the clinicians responsible for the ACO's performance-year spending. The recommendation would make the baseline and performance-year spending better reflect the practice patterns of the ACO's performance-year clinicians.

Three corollaries to this recommendation would need to be included:

- If an NPI is used to bill under an ACO's participating TIN during the performance-year assignment period, CMS should use all primary care visits in the ACO's market billed from that NPI (regardless of what TIN the visits are billed under) to assign beneficiaries to that ACO in its performance year and baseline years. Doing so would prevent the ACO from allocating high-spending patients to a TIN not in the ACO. Thus, it would partially address selection against high-spending patients.
- Claims occurring outside the ACO's current market should be removed from assignment calculations to prevent claims from other areas being considered if clinicians either join the ACO after moving from a different market or leave the ACO midway through the performance assignment period and move to a different market.

- Clinicians' claims would be used only for assignment to a single ACO to prevent selection among patients by a clinician billing under multiple TINs.

RATIONALE 2

The integrity of using historical benchmarks requires reliably matching the ACO's performance-year clinicians with the ACO's historical primary care visits. The risk is that allowing ACOs to benefit from changing NPI participation in TINs creates potentially perverse incentives and could produce unwarranted shared savings. ACOs should be rewarded for improving patient outcomes and achieving real savings due to appropriately managing utilization—not for apparent gains that result from mismatches between performance-year and benchmark-year clinicians (whether intentional or unintentional). The recommendation would help reduce unwarranted shared savings by using the same NPIs to compute baseline spending as are used to compute performance-year spending. ACOs that shift providers to TINs outside the ACO would not be able to benefit from a mismatch of NPIs used to create benchmarks and NPIs used to evaluate performance.

IMPLICATIONS 2

Spending

- The recommendation is expected to generate a small reduction in Medicare spending due to reduced shared savings payments. The Congressional Budget Office estimates savings of less than \$50 million over one year and less than \$1 billion over five years.

Beneficiaries and providers

- The recommendation is not expected to affect beneficiaries' care. The recommendation will affect ACOs' shared savings payments only to the extent that ACOs shift NPIs into or out of the TINs under which the ACO submits claims. ■

Endnotes

- 1 In 2019, new ACOs joined the program in July, not January as they had in other years.
- 2 Clinicians with a minimum share of professional services payments (or patients) coming through an A-APM qualify for the 5 percent incentive payment. To qualify for the incentive payment in 2020, for example, clinicians must have received at least 25 percent of their Medicare professional services payments through an A-APM in 2018 or delivered services to at least 20 percent of their patients through an A-APM in 2018. A-APMs include Next Generation ACOs and MSSP ACOs in the highest level of the basic track and in the enhanced track.
- 3 The ACOs we interviewed included physician-led and health system-affiliated ACOs, and the states were in the Southwest, South, and Midwest.
- 4 CVS Caremark has previous partnerships with five other Medicare ACOs through its SilverScript PDP. In 2014, it expanded its ACO collaborations to include an additional seven ACOs (Pioneer and MSSP ACO partners all located in California, Florida, or New Jersey) (Avalere Health 2014).
- 5 In lieu of TINs, the MSSP assigns beneficiaries based on a CMS certification number for ACO participants that are federally qualified health centers, rural health clinics, critical access hospitals, and electing teaching amendment hospitals. For these types of providers in the NextGen ACO demonstration, CMS assigns beneficiaries using a combination of a CMS certification number and a national provider identifier.
- 6 Historical expenditures from the first and second baseline years are trended forward to the third baseline year. Expenditures from the first and second baseline years are also adjusted based on their average risk score differential (represented by a ratio of average risk scores relative to baseline year 3). In computing the historical portion of the benchmark, the third baseline year (most recent) is weighted at 60 percent, the second baseline year is weighed at 30 percent, and the first baseline year is weighted at 10 percent.
- 7 CMS annually recalculates historical benchmarks based on the updated list of TINs submitted by the ACO. The list of participating TINs in each ACO can differ markedly from year to year. We examined the consistency of TINs participating in MSSP ACOs in 2016 and 2017. Among the TINs that were reported as participating in MSSP ACOs in 2016, 15 percent were removed from the ACOs' participant lists in 2017. The share of TINs removed in 2017 was higher for physician-only ACOs (20 percent) than for ACOs with a hospital (12 percent). Among MSSP TINs in 2017, 22 percent were added to ACOs from the previous year. ACOs with a hospital added a slightly greater share of TINs (24 percent) compared with physician-only ACOs (21 percent).
- 8 NPIs included in multiple ACOs also create potential ambiguity in assignment for beneficiaries who voluntarily align themselves with an ACO through their designation of a primary care clinician on the MyMedicare.gov website. At any time during the year, a beneficiary may log into MyMedicare.gov and designate a primary care clinician who they believe is responsible for coordinating their overall care. However, to date, this option has seldom been used by beneficiaries.
- 9 PCPs were identified by specialty codes for general practice, family practice, internal medicine, pediatric medicine, and geriatric medicine. To be eligible for assignment, beneficiaries must have an office visit from at least one of these specialties. The determination of assignment—as measured by the plurality of primary care visits—includes nonphysician providers such as physician assistants and nurse practitioners. However, these providers do not currently report a specialty, which raises some issues such as those who work for an orthopedist being assumed to be providing primary care. The Commission has recommended that these practitioners use their own NPI for billing and report a specialty (Medicare Payment Advisory Commission 2019).
- 10 Among ACOs in the MSSP in 2017, 16 ACOs removed more than 20 percent of the TIN-NPI combinations of PCPs from the previous year.
- 11 For ACOs starting a second MSSP agreement in 2017 or later and for any MSSP ACOs starting any agreement as of July 2019 or later, benchmarks are calculated using a blend of the ACO's own historical spending and the ACO market's regional spending. Each subsequent MSSP agreement requires benchmarks to place greater weighting on regional spending (up to a cap of 50 percent). Before January 2019, ACOs could not increase their risk scores for continuing enrollees beyond the average increase for assignment-eligible beneficiaries with the same demographic characteristics. As of July 2019, ACOs can increase their risk scores by up to 3 percent relative to the assignment-eligible beneficiaries with the same demographic characteristics.
- 12 When examining 2017 preliminary and final assignment, we included only beneficiaries who (1) resided in the same county from 2016 to 2017, (2) did not have any 2017 enrollment in MA, and (3) had at least one month of enrollment in Medicare Part A and Part B in 2017.

- 13 There is a third type of assignment that is partly prospective. Under MSSP prospective assignment, the patient is preliminarily assigned to the ACO based on the prior year's visits. But to maintain that assignment, the patient needs to receive some kind of primary care visit with the ACO (but not necessarily the plurality of visits). Some commercial ACOs apply prospective assignment differently from the NextGen program. For example, under the AQC HMO model in Massachusetts, enrollees pick a primary care physician and then are prospectively assigned based on that choice of primary care physician.
- 14 To compare patients who received their first AWV in 2015 with those who did not, we included only markets where the ACO had at least 100 assigned beneficiaries that received an AWV in 2015. Markets were defined as urban metropolitan statistical areas within a state or all rural counties within a state.
- 15 "Any ACO participant, as identified by the taxpayer identification number (TIN), that has a specialty used in assignment (42 CFR §425.402) and bills Medicare for primary care services must be exclusive to a single Shared Savings Program ACO. However, individual practitioners, identified by individual National Provider Identifiers (NPIs), are free to participate in multiple ACOs if they bill under several different TINs" (<https://www.cms.gov/Medicare/Medicare-Fee-for-Service-Payment/sharedsavingsprogram/for-providers>).
- 16 PCPs and eight specialties accounted for nearly all MSSP assignment in 2017. Cardiology and hematology accounted for about half of the beneficiaries assigned through specialties.

References

- Avalere Health. 2014. CVS Caremark announces new partnerships with Medicare ACOs to reduce drug spending. <https://avalere.com/insights/cvs-caremark-announces-new-partnerships-with-medicare-acos-to-reduce-drug-spending/>.
- Barnett, M. L., and J. M. McWilliams. 2018. Changes in specialty care use and leakage in Medicare accountable care organizations. *American Journal of Managed Care* 24, no. 5 (May 1): e141–e149.
- Brennan, T. 2017. Evaluating adherence in accountable care organizations. CVS Health commentary. <https://payorsolutions.cvshealth.com/sites/default/files/cvs-health-payor-solutions-evaluating-adherence-in-accountable-care-organizations-commentary-jul-2017-download.pdf>.
- Briggs, A. D. M., T. K. Frazee, A. L. Glick, et al. 2019. How do accountable care organizations deliver preventive care services? A mixed-methods study. *Journal of General Internal Medicine* 34, no. 11 (November): 2451–2459.
- Centers for Medicare & Medicaid Services, Department of Health and Human Services. 2018a. Medicare program; Medicare Shared Savings Program; accountable care organizations—Pathways to Success and extreme and uncontrollable circumstances policies for performance year 2017. Final rule. *Federal Register* 83, no. 249 (December 31): 67816–68082.
- Centers for Medicare & Medicaid Services, Department of Health and Human Services. 2018b. Medicare program; Medicare Shared Savings Program; accountable care organizations—Pathways to Success. Proposed rule. *Federal Register* 83, no. 160 (August 17): 41786–41951.
- Colla, C. H., V. A. Lewis, B. R. Beaulieu-Jones, et al. 2015. Role of pharmacy services in accountable care organizations. *Journal of Managed Care & Specialty Pharmacy* 21, no. 4 (April): 338–344.
- Ganguli, I., J. Souza, J. M. McWilliams, et al. 2019. Association of Medicare’s annual wellness visit with cancer screening, referrals, utilization, and spending. *Health Affairs* 38, no. 11 (November): 1927–1935.
- Haber, S., H. Beil, P. Amico, et al. 2018. *Evaluation of the Maryland all-payer model: Third annual report*. Report prepared for the Centers for Medicare & Medicaid Services. Prepared for the Centers for Medicare & Medicaid Services. Waltham, MA: RTI International.
- McWilliams, J. M., M. E. Chernew, B. E. Landon, et al. 2015. Performance differences in year 1 of Pioneer accountable care organizations. *New England Journal of Medicine* 372, no. 20 (May 14): 1927–1936.
- McWilliams, J. M., L. A. Hatfield, M. E. Chernew, et al. 2016a. Early performance of accountable care organizations in Medicare. *New England Journal of Medicine* 374, no. 24 (June 16): 2357–2366.
- McWilliams, J. M., L. A. Hatfield, M. E. Chernew, et al. 2016b. Supplementary appendix to: McWilliams, J. M., L. A. Hatfield, et al. Early performance of accountable care organizations in Medicare. *New England Journal of Medicine* 374: 2357–2366. http://www.nejm.org/doi/suppl/10.1056/NEJMsa1600142/suppl_file/nejmsa1600142_appendix.pdf.
- McWilliams, J. M., L. A. Hatfield, B. E. Landon, et al. 2018. Medicare spending after 3 years of the Medicare Shared Savings Program. *New England Journal of Medicine* 379, no. 12 (September 20): 1139–1149.
- Medicare Payment Advisory Commission. 2019. *Report to the Congress: Medicare and the health care delivery system*. Washington, DC: MedPAC.
- Medicare Payment Advisory Commission. 2016. *Report to the Congress: Medicare payment policy*. Washington, DC: MedPAC.
- Muhlestein, D., W. Bleser, R. Saunders, et al. 2019. Spread of ACOs and value-based payment models in 2019: Gauging the impact of Pathways to Success. *Health Affairs* blog. October 21. <https://www.healthaffairs.org/doi/10.1377/hblog20191020.962600/full/>.
- NORC at the University of Chicago. 2020. *Second evaluation report: Next Generation Accountable Care Organization Model evaluation*. Report prepared by staff from NORC at the University of Chicago for the Center for Medicare & Medicaid Innovation. Bethesda, MD: NORC.
- NORC at the University of Chicago. 2018. *First annual report: Next Generation Accountable Care Organization (NGACO) Model evaluation*. Report prepared by staff from NORC at the University of Chicago for the Center for Medicare & Medicaid Innovation. Bethesda, MD: NORC.
- RAND Corporation. 2018. *Effects of health care payment models on physician practice in the United States: Follow-up study*. Research highlight. Santa Monica, CA: RAND.

Roberts, E. T., J. M. McWilliams, L. A. Hatfield, et al. 2018. Changes in health care use associated with the introduction of hospital global budgets in Maryland. *JAMA Internal Medicine* 178, no. 2 (February 1): 260–268.

RTI International. 2012. *Evaluation of the Medicare Physician Group Practice Demonstration*. Report prepared by RTI International for the Centers for Medicare & Medicaid Services. Baltimore, MD: CMS.

Song, Z. 2020. Personal communication with the author, February 7.

Song, Z., Y. Ji, D. G. Safran, et al. 2019. Health care spending, utilization, and quality 8 years into global payment. *New England Journal of Medicine* 381, no. 3 (July 18): 252–263.

Song, Z., S. Rose, M. E. Chernew, et al. 2017. Lower- versus higher-income populations in the Alternative Quality Contract: Improved quality and similar spending. *Health Affairs* 36, no. 1 (January 1): 74–82.

CHAPTER

3

**Replacing the
Medicare Advantage
quality bonus program**

R E C O M M E N D A T I O N

- 3** The Congress should replace the current Medicare Advantage (MA) quality bonus program with a new MA value incentive program that:
- scores a small set of population-based measures;
 - evaluates quality at the local market level;
 - uses a peer-grouping mechanism to account for differences in enrollees' social risk factors;
 - establishes a system for distributing rewards with no "cliff" effects; and
 - distributes plan-financed rewards and penalties at a local market level.

COMMISSIONER VOTES: YES 17 • NO 0 • NOT VOTING 0 • ABSENT 0

Replacing the Medicare Advantage quality bonus program

Chapter summary

The Commission maintains that Medicare program payments should take into account the quality of care delivered to beneficiaries. In our June 2018 report to the Congress, we formalized a set of principles for designing Medicare quality incentive programs. Medicare’s quality bonus program (QBP) for assessing quality performance in the Medicare Advantage (MA) program is not consistent with these principles. In our June 2019 report to the Congress, we outlined flaws of the QBP program, which:

- scores too many measures, including “insurance function” or administrative measures;
- uses measures reported at the MA contract level, even for contracts encompassing disparate geographic areas, making plan ratings not necessarily a useful indicator of quality provided in a beneficiary’s local area;
- has allowed companies to consolidate contracts to obtain unwarranted bonuses;
- does not appear to adequately account for differences in enrollee social risk factors;
- has moving performance targets that do not permit plans to know ahead of time how their quality results translate to a QBP score; and

In this chapter

- Quality in Medicare Advantage is difficult to evaluate and the quality bonus program is flawed
- Design of the new MA–VIP addresses flaws in the current MA quality bonus payment system
- Illustrative scoring and payment adjustments under the MA–VIP model
- Replacing the Medicare Advantage quality bonus program with a new value incentive program

- is not budget neutral because it is financed with additional program dollars—unlike quality incentive programs in Medicare’s traditional fee-for-service program that are either budget neutral (balancing penalties and rewards) or penalty only.

The flaws of MA quality measurement must be addressed so that Medicare can have confidence that the MA program encourages and appropriately rewards high quality in a manner that ensures that program dollars are wisely spent.

Fixing MA’s quality incentive program is particularly important. More than one-third of Medicare beneficiaries receive their care through MA plans, and overall program payments in MA totaled about \$274 billion in 2019. In the same year, MA’s QBP cost \$6 billion and is projected by the Congressional Budget Office to cost \$94 billion over 10 years. The Commission has discussed moving Medicare into more value-based payment models in which an entity is accountable for both the cost and quality of care provided to Medicare beneficiaries on a population basis. MA is such a model, but the current state of quality reporting and measurement in MA does not provide a basis for properly evaluating the effectiveness of this model.

In the June 2019 report, we introduced an alternative MA value incentive program (MA–VIP). In this report, the Commission recommends that the Congress replace the QBP with an MA–VIP that includes the five key design elements described below. This recommendation would produce savings for the Medicare program and its beneficiaries. In making this recommendation, which involves a reduction in overall MA payments, the Commission is not rendering a judgment on the appropriate level of aggregate payments to MA plans.

The Commission’s recommended MA–VIP would:

- ***Score a small set of population-based measures.*** The MA–VIP measure set would be tied to clinical outcomes as well as patient/enrollee experience. CMS should develop the MA–VIP measure set through a public review and input process. We anticipate that the MA–VIP measure set would continue to evolve as the quality and completeness of MA encounter data improve and patient-level clinical data from electronic health records and other clinical sources become available for quality measurement.
- ***Evaluate quality at the local market level.*** The MA–VIP would evaluate MA plan quality at the level of local market areas because it provides information about the quality of care delivered in the localities in which beneficiaries seek and receive care.

- ***Use a peer-grouping mechanism to account for differences in enrollees' social risk factors.*** In determining the distribution of quality-based payments in each market area, the MA–VIP would consider differences in plans' enrolled population by stratifying results by defined peer groups, using social risk factors such as eligibility for Medicaid, eligibility for the Part D low-income subsidy, disability status, and area deprivation indexes. Comparing performance among groups with similar characteristics accounts for social risk factors without masking disparities in plan performance, as would be the case if measure results themselves were adjusted by population social risk characteristics.
- ***Establish a system for distributing rewards with no “cliff” effects.*** The MA–VIP would reward or penalize a plan based on the plan's performance relative to other plans in the market using a continuous, prospectively set performance-to-points scale for each measure. The use of continuous performance-to-points scales allows plans that improve to earn points and avoids the “cliff” effect, whereby only those plans achieving a certain level of quality receive bonuses.
- ***Distribute plan-financed rewards and penalties at the local market level.*** The MA–VIP would redistribute a pool of dollars (made up of a share of plan payments within a market area) as rewards and penalties based on a plan's performance compared with the market area's other plans.

To test the proof of concept of the MA–VIP design, we modeled a prototype MA–VIP using currently available data. We calculated quality measure results using administrative data for a set of six measures tied to clinical outcomes, along with patient-reported outcomes and experience measures based on survey data. We modeled the MA–VIP scoring and payment adjustments in 61 local market areas that had at least 3 parent organizations meeting minimum sample size requirements for all measures in our modeling measure set. We used nationally determined performance-to-points scales to convert each parent organization's quality results to MA–VIP points. We accounted for social risk factors in plan populations by stratifying parent organizations' enrollees in each market into two peer groups based on their enrollees' fully dual-eligible status. Each peer group in a market area had a pool of dollars based on 2 percent of the parent organization's payments tied to the peer group.

Overall, our illustrative MA–VIP prototype demonstrates the feasibility of implementing a quality performance measurement program that is consistent with the Commission's principles. In stratifying results by peer groups, the MA–VIP accounts for differences in the social risk factors of plan populations and gives plans the opportunity to earn more rewards for higher quality care provided to their fully

dual-eligible population as compared with their non-fully dual-eligible populations. We found stratifying by social risk factors to produce more fair competition in the majority of markets in our illustrative modeling. We also found that, compared with the QBP, the MA-VIP stratification into peer groups and the market-level comparison approach helps to narrow disparities in payments for plans serving higher shares of fully dual-eligible beneficiaries.

Our results indicated that an MA-VIP was feasible. An illustrative withhold of 2 percent of payments yielded small penalties and rewards for each peer group for most parent organizations in a market area. The magnitude of payment adjustments would change based on the size of the reward pool (our modeling used 2 percent of plan payments, but the percentage could be set higher) and how the performance-to-points scale for each measure is set. Policymakers should consider performance scale methodology and an appropriate amount of payment to fund the reward pool that would drive quality improvement.

The current practice of collecting data and measuring quality at the MA contract level limited the availability of data to use in our modeling, which was conducted at the parent organization and local market level. Moreover, the model is not meant to be an exact formula for how the Congress and CMS should implement an MA-VIP. If a new value incentive program is enacted by the Congress, CMS should use the formal rule-making process to select measures, set performance-to-points scales, define the social risk factors that are accounted for in peer groups, and determine the share of plan payments used to fund reward pools. ■

Quality in Medicare Advantage is difficult to evaluate and the quality bonus program is flawed

The Commission maintains that Medicare payments should not be made without considering the quality of care delivered to beneficiaries and has formalized a set of principles for designing Medicare quality incentive programs (Medicare Payment Advisory Commission 2018a). The Commission has been working to redesign Medicare's range of quality incentive programs to be consistent with these principles, such as with the recommendation to implement a hospital value incentive program (Medicare Payment Advisory Commission 2019c).

Reports by the Commission in 2018 and 2019 discuss at length the difficulties in evaluating the quality of care in Medicare Advantage (MA) (Medicare Payment Advisory Commission 2019c, Medicare Payment Advisory Commission 2018b). Indeed, the state of quality reporting in MA is such that the Commission's yearly updates to MA can no longer provide an accurate description of the quality of care in MA. Also, the current quality bonus program (QBP) is overly complex, distributes financial rewards inequitably, and reports inaccurate information on quality. These flaws must be addressed to ensure that the MA program promotes and appropriately rewards high quality and provides accurate information to beneficiaries and policymakers.

The QBP is costly to Medicare and to taxpayers and beneficiaries who finance the program. The QBP is financed with added program dollars, and the number of entities receiving bonus dollars has increased to the point that the financial incentives of the program no longer achieve the original intention of recognizing only the best performing entities, given that over half of all MA contracts, representing 83 percent of MA enrollment, are in bonus status. The current QBP used trust fund and taxpayer dollars to increase MA payments by about 2.3 percent, or \$6 billion, in 2019. Financing the QBP with additional program dollars is inconsistent with the budget-neutral nature of most fee-for-service (FFS) quality incentive programs (some of which involve only penalties), creating an uneven playing field between MA and FFS (including the quality incentive programs for accountable care organizations (ACOs) in FFS).

Fixing MA's quality measurement and quality incentive program is of the highest importance since more than one-third of beneficiaries receive their care through MA plans, and program payments in MA totaled about \$274 billion in 2019. The Commission has discussed moving Medicare into more value-based payment models in which an entity is accountable for both the cost and quality of care provided to Medicare beneficiaries on a population basis. MA is such a model, but the current state of quality reporting and measurement in MA does not provide a basis for properly evaluating the effectiveness of this model, nor does the current system provide accurate information to beneficiaries. The flaws of MA quality measurement must be addressed so that Medicare can have confidence that the MA program encourages and appropriately rewards high quality in a manner that ensures that program dollars are wisely spent. While the QBP was intended to reward high quality, the QBP has also been the source of added program payments unrelated to quality.

The quality bonus program and its flaws

The Affordable Care Act of 2010 called for CMS to institute a QBP for MA beginning in 2012. The law specifies that a 5-star rating system be used to determine MA plans' eligibility for bonus payments. The statute did not provide additional guidance on the structure or operation of the star system, but CMS had already been using a 5-star rating system to inform beneficiaries of MA quality. Plans rated 4 stars or higher ("in bonus status") are rewarded by receiving an increase in their MA benchmarks of 5 percent or, in some counties, 10 percent. (A higher benchmark can result in an increased level of extra benefits for plan enrollees, but when a benchmark increases because of bonus payments, there is no requirement that all the bonus dollars be used to finance extra benefits. A higher benchmark can also result in a plan increasing its bid—that is, increasing its payments to providers for the Medicare benefit package and retaining more dollars for profit and administration rather than applying the benchmark increase toward the computation of rebate dollars that finance extra benefits.)

MA star ratings are based on 45 measures of clinical quality, patient experience, and administrative performance. For each measure, a contract receives a score from 1 to 5 stars. The categories of measures, as defined by CMS, have different weights: 1 for process measures, 1.5 for access and patient experience measures,

3 for outcome measures, and 5 for the two improvement measures that CMS computes. The overall star rating is the weighted average of all the measures a plan can report (and the plan must report at least half of the measures). Certain adjustments are made to arrive at a final overall star rating, including an adjustment for contracts with high shares of low-income enrollees and enrollees entitled to Medicare on the basis of disability.

For most of the star measures, CMS grades plan performance using a “tournament model” to determine the threshold, or “cut point,” for each level of the star ratings (e.g., the measure value that is the cut point distinguishing between a 4-star and 5-star result for the measure). Under this model, plans are measured against each other’s performance, not against a set performance target. Each year, individual measure results are classified (clustered) into five groups, with the highest group at 5 stars and the lowest at 1 star. Under this system, each of the cut points distinguishing the five groupings can be higher or lower from year to year, thus producing shifting performance targets.

In addition to being the basis of bonus payments, the star rating system is intended to be a source of information about MA quality for beneficiaries (see text box about public reporting of quality information and the MA value incentive program (MA-VIP), p. 59). Star ratings—both the overall ratings and star levels for individual measures—are posted on the Medicare Plan Finder site of Medicare.gov. The ratings are updated each October for the October–December annual election period (when beneficiaries can move among plans or between MA plans and FFS Medicare).

As of February 2020, among MA contracts with any star rating, about 83 percent of MA beneficiaries were enrolled in MA plans in bonus status under the 2020 ratings released in October 2019. We estimate that the QBP constitutes about 2.3 percent of aggregate payments to MA plans, or about \$6 billion a year in additional program costs. This level of additional program expenditure means that all of the nearly 60 million Medicare beneficiaries who have Medicare Part B are obligated to pay an additional \$1 per month in their Part B premium—an obligation that also strains state finances because the states pay the Part B premium for the 12 million Medicare beneficiaries who are dually eligible for Medicare and Medicaid.

The QBP has undergone several changes over the years. Some have been in response to, or consistent with,

recommendations or observations the Commission has made with a view toward improving the QBP. At the same time, policy decisions allowing companies to use the contract consolidation strategy to raise star ratings—by merging lower rated contracts with higher rated contracts and allowing plans to choose the higher rating as applicable to the entire consolidated contract—have been detrimental to the program (Medicare Payment Advisory Commission 2019a).

In addition to concerns about cost, the QBP is flawed in that:

- too many measures are scored, diluting results aimed at assessing quality;
- reporting units do not represent market area performance;
- plans are scored against moving, rather than preset, targets; and
- the QBP’s method of accounting for differences in enrollees’ social risk factors does not appear to be effective at addressing these differences.

Overpayments in the MA QBP persist as information on quality continues to become less reliable

Both before the QBP and in its early years, very few enrollees were in plans rated 4 stars or higher in CMS’s 5-star system that predates the QBP. In 2011, about 23 percent of MA enrollees were in such plans, and in 2012, the first year of the QBP, about 28 percent of enrollees were in plans meeting the statutory requirement for bonus eligibility (a rating of 4 stars or higher). However, since its inception in 2012, the QBP has been characterized by excess payments unrelated to quality in that CMS used its demonstration authority from 2012 through 2014 to implement an MA-wide demonstration to pay bonuses to contracts rated below 4 stars. Virtually all contracts received bonus payments under the demonstration (e.g., for 90 percent of enrollees in 2012). The Government Accountability Office found that the demonstration resulted in payments of \$8 billion to plans rated below 4 stars (and for payments exceeding other limits the Affordable Care Act of 2010 imposed on QBP payments) and that the demonstration was implemented using questionable legal authority (Government Accountability Office 2012).

In addition, beginning with the March 2015 report to the Congress, each year the Commission has called attention

FIGURE 3-1

The share of MA enrollees in plans rated 4 stars or higher increased from about one-third to over 80 percent between 2013 and 2020, with consolidations adding to the share in recent years

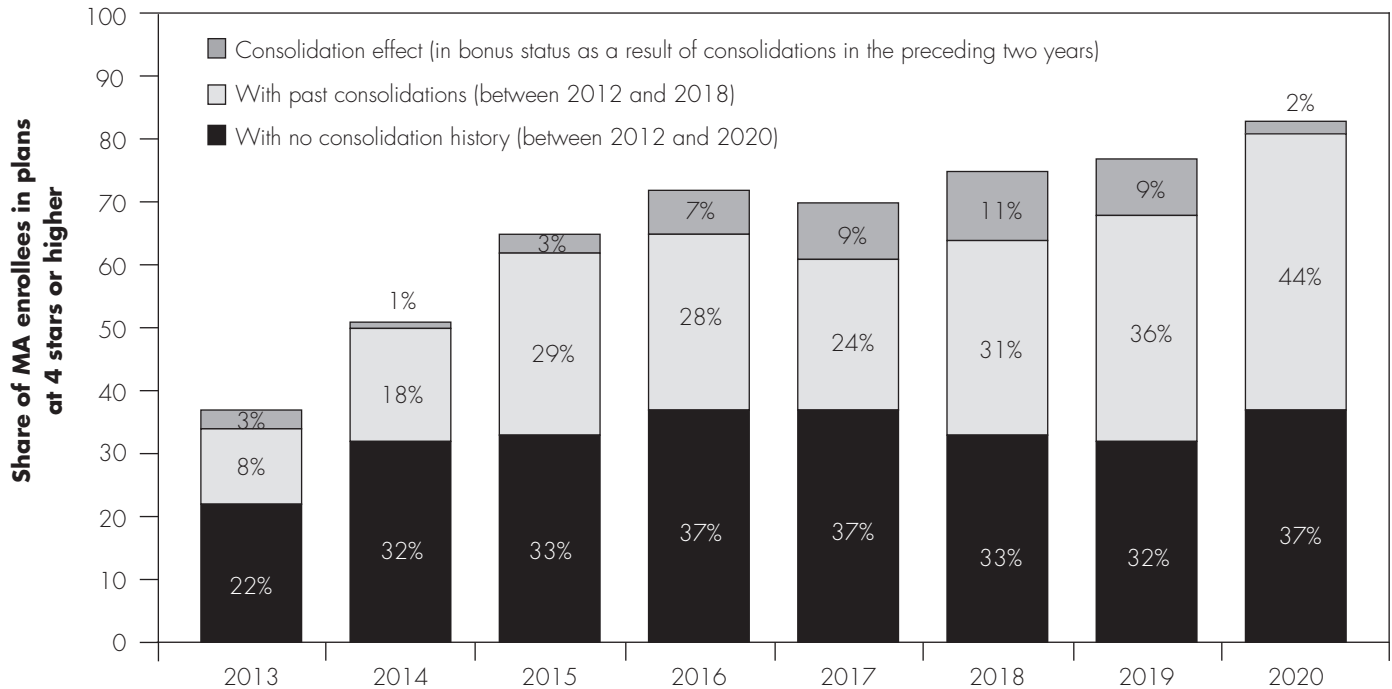

Note: MA (Medicare Advantage). Numbers are rounded amounts. The consolidation effect (marginal consolidation effect) is the share of beneficiaries in bonus-status plans as a result of consolidation, which is the sum of the enrollment moved to bonus status over the two years preceding the year indicated and excluding any enrollees not in a bonus-status plan in the second year of the consolidation effect. It is not until the third year of a consolidation that there can be a star rating that incorporates quality results for enrollees added through a contract consolidation.

Source: MedPAC analysis of CMS enrollment and star rating reports.

to a practice resulting in unwarranted bonuses, which is the use of contract consolidations to achieve bonus status through the mechanism discussed in detail most recently in the March 2018 and March 2019 reports to the Congress (Medicare Payment Advisory Commission 2019c, Medicare Payment Advisory Commission 2018b). Between 2013 and 2020, 81 MA contracts were involved in contract consolidations that moved millions of MA enrollees to bonus-status contracts. Between 2014 and 2018, slightly over 4 million MA enrollees were moved to bonus-status contracts, with plans receiving unwarranted bonuses for those enrollees over at least 2 years (owing to the timing of how star ratings affect payments to plans). In many cases, contracts that were the result of consolidations became absorbed through subsequent consolidations that would maintain the enrollees in bonus-level contracts. By

2020, 83 percent of MA enrollees were in plans with 4 or more stars, up from 33 percent in 2013 (the sum of the three numbers for each year in Figure 3-1). Looking at the shares of 2020 enrollment in any plan with an overall star rating, of the share of enrollees in bonus-level plans (plans rated 4 stars or higher): 37 percent of enrollment is in contracts with no history of any consolidations between 2012 and 2020; 44 percent in contracts that had at least one consolidation between 2012 and 2018; and 2 percent in bonus status as a result of contract consolidations to move to bonus status in the preceding two years (in this case (year 2020), only at the end of 2018, because there was no such consolidation activity at the end of 2019).

Contracts that have had consolidation activity comprise the majority of enrollment in bonus-level contracts (10.7 million of 19.2 million enrollees (56 percent) are in

**FIGURE
3-2**

There is a two-year effect on contract bonus ratings after a consolidation and before results for combined populations can be factored into star ratings

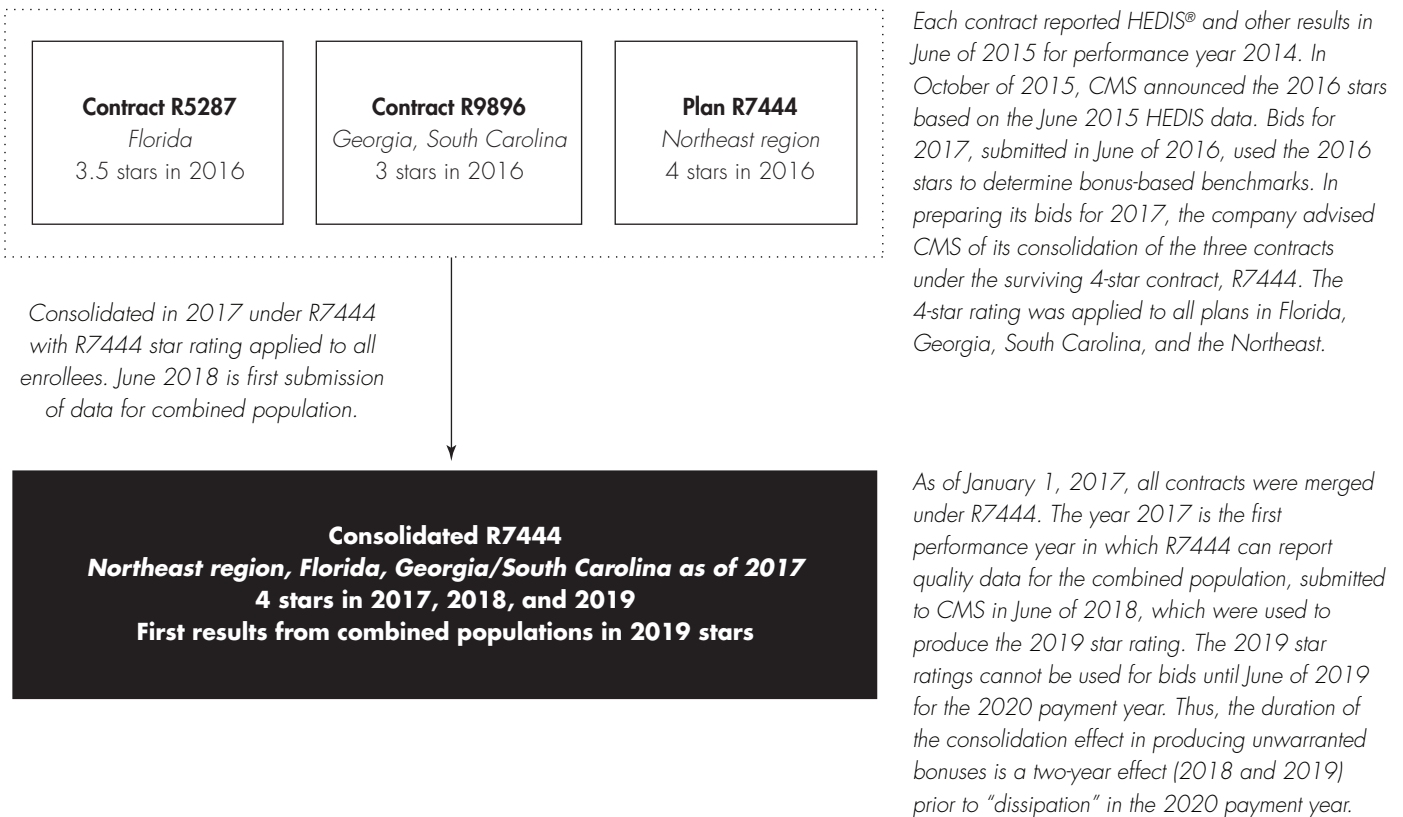

Note: HEDIS® (Healthcare Effectiveness Data and Information Set®). Northeast region for regional plans consists of Connecticut, Massachusetts, Rhode Island, and Vermont.

Source: MedPAC analysis of CMS stars and enrollment data.

contracts with a bonus-level star rating); contracts that include at least one consolidation comprise the majority of enrollment in contracts with any star rating (12.1 million of 23.2 million enrollees, or 52 percent). (Data not shown in Figure 3-1 (p. 53).)

Recent legislation, effective January 1, 2020, changed the policy with respect to consolidations so that consolidated contracts receive the weighted average star rating of the combined contracts. The new policy still permits organizations to obtain unwarranted bonuses by combining lower rated contracts with higher rated contracts when the averaging method yields an overall bonus-level star rating. The legislation has thus narrowed, but not eliminated, the

opportunities for plans to obtain unwarranted bonuses through consolidations.¹

Plans are also employing other strategies to obtain unwarranted bonuses. One strategy capitalizes on the CMS policy that gives new contracts under an existing parent organization the average star rating of the parent organization. In one instance, a company started a new contract as of January 1, 2020, but was able to move more than 100,000 enrollees from counties where it terminated a prior contract into the new contract. The new contract will have a 4-star rating for bidding purposes for the 2021 payment year (2020 bids) as well as for the 2022 payment year (if the company maintains a 4-star average) because

the new contract will not receive its own star rating until October 2021—too late to use for the June 2021 bidding that affects payments in 2022. Medicare beneficiaries will not see star ratings for new contracts until at least two years after the inception of the contract.

CMS has also permitted a company to deconsolidate a set of regional preferred provider organization (PPO) contracts after a consolidation that allowed the company to receive unwarranted bonuses (Medicare Payment Advisory Commission 2017). By restoring the preconsolidation contract configuration, the company is likely to have at least one contract in bonus status while the consolidated configuration would have been a nonbonus situation for all enrollees. The option of deconsolidation after a consolidation, and the ability to change from a consolidated to a deconsolidated configuration (or vice versa) from one year to the next—particularly if the option extends to local contracts as well as regional contracts—is thus another strategy that can result in unwarranted bonus payments.

The lasting effects of consolidations

In addition to being the source of unwarranted bonus payments, past consolidations have produced large multistate contracts, resulting in beneficiaries receiving inaccurate information about MA quality in their local market area. The detrimental effect of past consolidations on the accuracy of plan information about quality cannot be undone. As we have noted, more than half of all MA enrollees are in plans in which the star ratings and quality data reported at the Medicare.gov website are unlikely to accurately reflect the local quality of care. While the recent legislation lessens the concern over unwarranted bonus payments, the continuing ability of plans to consolidate has the potential to exacerbate the information vacuum that beneficiaries have faced because of past consolidations. In addition, CMS continues to permit contracts with wide, disparate geographic areas for new contracts, which perpetuates the problem.

When does the consolidation effect dissipate?

An issue that the Commission has discussed revolves around the estimate of the program expenditures for the bonus program and whether the figure of approximately \$6 billion annually will be less in future years as the effect of consolidations on star ratings dissipates. To be clear about what the \$6 billion represents, it is the total program cost of the QBP—not solely the dollars expended for

unwarranted bonuses. The assumption of a dissipation effect is that the total program cost of the QBP will be less in the future because the star rating of the consolidated organization will decline once the rating is determined based on results for the combined set of enrollees. Figure 3-2 shows how the effect of a consolidation on star ratings will manifest after two years in a specific case.

For all plans, the 2020 star ratings, affecting 2021 payments, are based on performance in 2018 (for Healthcare Effectiveness Data and Information Set[®] (HEDIS[®]) measures) and therefore do not reflect any effects from consolidations occurring before 2018.² Because there was no consolidation activity at the end of 2019, the consolidation effect on 2020 stars is composed entirely of consolidations at the end of 2018. The 2018 consolidations affected 9 contracts with about 550,000 enrollees, and the total number of enrollees after consolidations, in the remaining 6 combined contracts, was a little over a million enrollees. It appears that of the 1 million enrollees in this set of beneficiaries, about 380,000 will be in contracts with a star rating below 4 stars, based on the computation of a weighted average of the last known ratings of the individual contracts. Therefore, about 2 percent of all enrollees in bonus-level plans reflects the effect of consolidations on 2020 star ratings. Thus, the potential for future dissipation of the consolidation effect is of limited magnitude and will not materially reduce the number of enrollees in bonus-level plans.

Design of the new MA–VIP addresses flaws in the current MA quality bonus payment system

In the June 2019 report to the Congress, we described an alternative to the QBP. The MA–VIP is designed to be patient oriented, encourage coordination across providers and time, and promote delivery system change but not be financed with added program dollars (consistent with the Commission’s original conception of a quality incentive program for MA). The MA–VIP to replace the QBP would:

- score a small set of population-based measures,
- evaluate quality at the local market level,
- use a peer-grouping mechanism to account for differences in enrollees’ social risk factors,

**TABLE
3-1**

How the proposed MA-VIP design addresses flaws in the current MA quality bonus program

Issue

How addressed in the MA-VIP

Too many measures, not focused on outcomes and patient/enrollee experience: The QBP adjusts payment based on plan performance on more than 40 measures that include process and insurance function measures. Many measures are collected through sample medical record reviews.

Score a small set of population-based measures: The MA-VIP adjusts plan payment based on plan performance on a small set of measures tied to clinical outcomes as well as patient/enrollee experience measures.

Contract-level quality measurement is too broad and inconsistent: Contracts can encompass broad, noncontiguous areas, and companies have had financial incentives to create larger multistate contracts. Contract-level reporting does not provide an accurate picture of quality for many areas.

Evaluate quality at the local market level: Evaluation of quality is at the local market level and no longer determined at the contract level.

Ineffective accounting for social risk factors: It is not clear that the current MA peer-grouping mechanisms are effective. Plans serving high-needs populations are less likely to receive bonus payments.

Use a peer-grouping mechanism to account for differences in enrollees' social risk factors: The MA-VIP stratifies enrollees into peer groups based on social risk factors and then calculates quality scores for each peer group.

"Cliff" effect system of awarding bonuses in which only plans receiving a set rating receive bonuses: The QBP scoring has a cliff effect, whereby only those contracts at or above a 4-star overall average receive bonuses.

Establish a system for distributing rewards with no "cliff" effects: The MA-VIP scores plan quality measure results against a continuous, performance-to-points scale that is known ahead of time.

Bonus financing is reward only: With financing from additional program dollars, the QBP is inconsistent with the budget-neutral FFS quality incentive programs and inconsistent with the Commission's original conception of a quality incentive system for MA plans.

Distribute plan-financed rewards and penalties at local market level: The MA-VIP redistributes a pool of dollars (made up of a share of plan payments) as rewards and penalties based on a plan's performance compared with the market area's other plans.

Note: MA-VIP (Medicare Advantage value incentive program), QBP (quality bonus program), FFS (fee-for-service).

- establish a system for distributing rewards with no "cliff" effects, and
- distribute plan-financed rewards and penalties at a local market level.

Table 3-1 summarizes the MA-VIP design and how it would address the QBP's design flaws.

Ideally, an evaluation of quality in MA would be based in part on a comparison with the quality of care in traditional FFS Medicare, including accountable care organizations, in local market areas (Medicare Payment Advisory Commission 2010a). Some research suggests that MA does have better quality, but a definitive finding is not possible because data sources for comparing MA with traditional FFS at the local market level are limited

(Medicare Payment Advisory Commission 2019c). Therefore, our proposed MA-VIP design does not yet include a component for FFS comparison. In the future, better encounter data from MA and expanded patient experience and patient-reported outcome surveys will help enable comparisons of the two programs.

Score a small set of population-based measures

Over the past several years, the Commission has expressed concern that the QBP is "overbuilt," by including "insurance function" or administrative measures and by relying on many clinical process measures that are weakly correlated with health outcomes of importance to beneficiaries and the program. The majority (31 of the

45 measures in the 2020 star ratings) are either process measures loosely tied to clinical outcomes (e.g., adult body mass index assessment, which simply indicates whether a person's body mass index was recorded in the medical record) or administrative measures (e.g., call center foreign language interpreter and TTY, or teletypewriter, availability). Many are plan-reported measures and require medical record review from a sample of enrollees. The proliferation of measures that are scored in the QBP gives plans several avenues to achieve a bonus-level overall rating, even if their performance is uneven and their results for outcome measures are below bonus-level performance.

Among the Commission's principles for Medicare quality incentive programs is the need to include a small set of population-based measures tied to clinical outcomes as well as patient/enrollee experience. Table 3-2 (p. 58) presents an illustrative example of an MA–VIP measure set consistent with this principle.³ The set includes measures that plans can influence through access to evidence-based clinical care, care coordination, and medication reconciliation. This illustration is not intended to be a definitive list, and CMS should develop the MA–VIP measure set through a public review and input process.⁴

The illustrative set of MA–VIP measures does not include many of the process measures and insurance function measures that are currently scored in the QBP, under the rationale that health plans should be held accountable for their insurance functions through compliance standards and enforcement and through public reporting, not through a quality payment program. Outside of the MA–VIP measures tied to payment, Medicare can use other quality measures and compliance standards to monitor MA plan performance and publicly report this information to encourage improvement (e.g., star ratings and display measures) (see text box on public reporting of quality information and the MA value incentive program, p. 59). For example, Medicare can continue to collect, track, and publicly report plan disenrollment rates.

So that the MA–VIP measures are not unduly burdensome for plans and providers, they should generally be calculated or administered by CMS, preferably with data that are already reported, such as claims, encounters, and enrollee survey data. In November 2019, the Commission discussed the importance of including in the MA–VIP measure set a small number of prevention and chronic care

management measures that are tied to clinical outcomes. Because of the lack of clinical information currently available in administrative data, plans would need to continue to gather data (e.g., hemoglobin A1c lab results for diabetic patients) from a sample of enrollee medical records and report validated measure results to CMS for some of the measures (for example, the HEDIS measures).

The MA–VIP measure set should evolve as better data and measures (e.g., lung cancer screening, patient-reported outcomes for depression and musculoskeletal conditions) become available. As MA plans continue to report encounter data to CMS for risk adjustment and other purposes, the completeness of the encounter data—specifically outpatient encounter data—may improve. Also, measure developers are beginning to produce specifications for plans to calculate measure results using data outside of traditional administrative (claims/encounter) data. The National Committee for Quality Assurance recently published measure specifications for health plans to calculate a small number of HEDIS measures using electronic clinical data systems, such as electronic health records, immunization information systems, and disease/case management registries.⁵ These digital measures have the potential to reduce plan and provider burden in collecting measure results and for plans to calculate measure results on the entire plan population as opposed to a sample of patient/enrollee medical records. However, these digital measure specifications are early in development and implementation and thus would not be available for scoring in the MA–VIP in the near future.

The illustrative MA–VIP measure set covers five measure domains (or measure groupings): (1) ambulatory care-sensitive (ACS) hospitalizations, (2) readmissions, (3) patient-reported outcomes, (4) patient/enrollee experience, and (5) staying healthy and managing long-term conditions. The five domains are generally consistent with the MA star rating domains. We assume that, like the star rating measure set, CMS would seek public input in developing the domains and that weighting of those domains would take into account interests shared by the Medicare program and its beneficiaries. When determining a star rating for each domain, CMS currently weights outcome and patient experience measures more than process measures.

The illustrative measure set includes 12 measures across the 5 domains (Table 3-2, p. 58), focusing on measures

**TABLE
3-2**

Illustrative MA-VIP measure set tied to clinical outcomes and patient/enrollee experience

Domain	Measures	Data source used to calculate measure results
ACS hospital use	1. ACS hospitalizations 2. ACS emergency department visits	Administrative data
Readmissions	3. Risk-adjusted rate of unplanned readmissions	Administrative data
Patient-reported outcomes	4. Improved or maintained physical health status 5. Improved or maintained mental health status	HOS survey data
Patient/enrollee experience	6. Getting needed care 7. Rating of health plan	CAHPS® survey data
Staying healthy and managing long-term conditions	8. Annual flu vaccine 9. Breast cancer screening 10. Colorectal cancer screening 11. Controlling high blood pressure 12. Diabetes: hemoglobin A1c poor control	CAHPS survey data, administrative data, medical record review

Note: MA-VIP (Medicare Advantage value incentive program), ACS (ambulatory care-sensitive), HOS (Health Outcomes Survey), CAHPS® (Consumer Assessment of Healthcare Providers and Systems®). Data sources used to calculate quality measure results include administrative (claims, encounter) data, information from medical record review, and survey data. Consumer Assessment of Healthcare Providers and Systems® is a registered trademark of the Agency for Healthcare Research and Quality.

that are patient oriented and that encourage coordination and promote delivery system changes. They are also closely tied to clinical outcomes and patient/member experience.

One important note about the illustrative measure set is that it would allow the Medicare program to compare MA plan quality within and across market areas, but would not allow a comparison of FFS and MA plan quality in market areas, which is an ultimate goal for the Medicare program. Such a comparison is not possible mainly because some of the measures (e.g., controlling high blood pressure) require MA plans to use clinical data to calculate results, and the Medicare program cannot currently access this level of clinical information from FFS providers. Also, CMS currently collects FFS Consumer Assessment of Healthcare Providers and Systems® (CAHPS®) results and reports them at a state level (and substate level for larger states) and not market-area level.⁶ CMS no longer fields the Health Outcomes Survey (HOS) for the FFS population. The Commission recommended in 2010 that the Secretary collect and

report HOS data for the FFS population (Medicare Payment Advisory Commission 2010b).

The MA-VIP illustrative measure set includes the following:

- **ACS hospital use:** Hospitalizations and emergency department (ED) visits due to ACS conditions such as diabetes and pneumonia are potentially preventable if ambulatory care is provided in a timely and effective manner. Patients may have required acute-level services at the time they sought care, but the need for the admission or ED visit might have been avoided with appropriate ambulatory care and coordination activities. Rates of ACS hospitalizations and ED visits can reflect an MA plan’s quality of care because high-quality MA plans should be able to manage beneficiary, hospital, and physician relations to coordinate care and provide appropriate access (Wholey et al. 2003). In practice, not every ACS hospitalization or ED visit can be avoided, but risk-standardized rates can reveal relative quality.

Public reporting of quality information should complement the MA value incentive program

CMS annually calculates the Medicare Part C (Medicare Advantage (MA)) and Part D star ratings to represent the quality of health and drug services received by beneficiaries enrolled in MA and in prescription drug plans (MA prescription drug plans and stand-alone prescription drug plans, or Part D plans). CMS publishes overall ratings for contracts, consisting of 1 to 5 stars (5 is the highest rating), on the Medicare Plan Finder website for each MA plan available to beneficiaries. On the Plan Detail web pages, consumers (i.e., beneficiaries, family members, counselors, brokers) have the option to view more about a health plan's and drug plan's quality information, including domain summary star ratings such as Staying Healthy, Managing Chronic Conditions, and Member Experience, as well as star ratings for the individual measures that make up each domain. CMS also reports some newer measure results that are not part of the star-rating calculations.

There are two main objectives for publicly reporting Medicare quality information. The first is to increase the accountability of health care organizations and providers, which offers patients, payers, and purchasers a more informed basis on which to hold providers accountable (e.g., directly through purchasing and treatment decisions). The second objective is to maintain standards and stimulate improvements in the quality of care through economic competition (reputation and increased market share) and by appeals

to health care professionals' desire to do a good job (Marshall et al. 2003). Researchers have identified and tested best practices on how to display comparative information to best meet the objectives of public reporting. Many such practices are incorporated in the MA star ratings—for example, using only a small number of data points (or the single data point of an overall star rating), with more detailed information available in a second or even third layer for those who want it (Agency for Healthcare Quality and Research 2020, *Aligning Forces for Quality* 2009).

Concurrent with the MA value incentive program's direct financial incentive for MA plans to improve care, CMS should continue to have a system and vehicle for publicly reporting quality information to beneficiaries. The design elements of both the quality payment and public reporting programs should generally align. For example, the local market area unit of measurement provides a more accurate picture of quality both for financially rewarding or penalizing performance and for informing beneficiary choice. Medicare should tie performance-based payment to a small set of measures linked to outcomes, but public reporting could include additional measure results to hold MA plans accountable for those measures. What quality information to report and how to report that information to consumers is a separate program design question that should be informed by research, best practices, and stakeholder input. ■

- **Readmissions:** Hospital readmissions are disruptive to patients and caregivers and costly to the health care system; they also put patients at additional risk of hospital-acquired infections and complications. Measuring and adjusting payments based on a plan's readmission rates holds the plan accountable for ensuring that beneficiaries have the discharge information they need and encourages the plan to facilitate coordination with other providers.
- **Patient-reported outcomes:** Beneficiaries are a valuable source of information on outcomes, so the MA–VIP should include enrollee-reported outcomes to assess the quality of care MA enrollees receive. MA plans are required to collect HOS results from a random sample of their Medicare enrollees and, two years later, to survey the same beneficiaries again (if they are still enrolled in the plan). Because the HOS often produces results showing no significant

outcome differences among MA plans, we encourage CMS to continue to improve the HOS instrument to meaningfully capture patient-reported outcomes, for example, by revising the number of surveys required to calculate reliable results (Medicare Payment Advisory Commission 2010b, Rose et al. 2019, Safran 2019).⁷

- **Patient/enrollee experience:** The MA–CAHPS is a national standardized survey instrument and data collection method for measuring enrollees’ perspectives on the quality of health services provided by MA plans. The survey results are used to calculate seven core measures of enrollee experience; they are star measures in the QBP and are publicly reported on the Medicare Plan Finder website, but the MA–VIP could score a subset of these measures, such as the measure for getting needed care and enrollees’ rating of their health plan.
- **Staying healthy and managing long-term conditions:** Preventive services, such as cancer screenings, are an important aspect of health care because they help beneficiaries stay healthier and get more-effective treatment. Chronic disease management is essential to both improving individuals’ health outcomes and potentially containing costs for the Medicare program. MA plans have multiple mechanisms (e.g., clinician incentives, case management, beneficiary screening reminders) to improve the preventive care and chronic care management their enrollees receive, so related measures tied to clinical outcomes should be included in the MA–VIP. These related measures include annual flu vaccine, breast cancer screening, colorectal cancer screening, controlling high blood pressure, and monitoring and controlling diabetes.

Evaluate quality at the local market level

The Commission has a long-standing recommendation that Medicare collect, calculate, and report quality measurement results in MA at a geographically local level because of differences in quality across geographic areas (Medicare Payment Advisory Commission 2010b). A major reason for the flaws in the current QBP is that the unit of measurement for evaluating and reporting on quality is the MA contract, yet MA contracts can cover disparate geographic areas. For example, one insurance company was allowed to have a contract with a service area consisting of counties in Hawaii and Iowa. The star rating for this contract would reflect performance

in two completely different service areas and may not accurately reflect plan quality in either area—making it impossible for the Medicare program to evaluate quality and for beneficiaries in these areas to reliably compare the quality of care when choosing an MA plan. As previously discussed, for 2020, CMS has permitted a number of new multistate contracts covering noncontiguous states. Another problem with using contract-level quality measures is that MA organizations can consolidate contracts, as discussed in an earlier section of the chapter.

We calculated quality results for the illustrative MA–VIP model, looking at each parent organization as identified in CMS data (e.g., United, Aetna, Kaiser Foundation Health Plans, Anthem) within a local market area (e.g., Washington, DC) rather than at the contract level.⁸ We included all the parent organization’s MA products (e.g., HMOs, PPOs, special needs plans) in the local market area quality results. Measuring at the product-type level would likely be too narrow for calculating results; measuring at the level of the parent organization is preferable because provider networks are substantially similar across product types, and Medicare should have the same expectations across all MA products.

Use a peer-grouping mechanism to account for differences in enrollees’ social risk factors

In evaluating quality, Medicare should consider, as necessary, differences in enrollee populations, including social risk factors. Medicare should stratify plan enrollment into groups of beneficiaries with similar social risk factors to determine payment adjustments. Comparing performance among groups with similar characteristics accounts for social risk factors without masking disparities in plan performance, as would be the case if measure results themselves were adjusted by population characteristics. (Outcome measures can be adjusted for patient-level clinical factors such as age, sex, and comorbidities.)

Currently, the QBP takes into account differences in a plan’s enrolled population, including social risk factors, by adjusting overall star ratings. CMS instituted a type of peer-grouping mechanism that modestly adjusts a contract’s overall star rating based on a contract’s share of low-income and disabled enrollees. Nevertheless, in our June 2019 report to the Congress, we showed that plans with a higher proportion of lower income enrollees continue to have lower overall star ratings.

We propose calculating the MA–VIP within a local market area with stratified quality scores for fully dual-eligible enrollees (Peer Group 1) and all other enrollees (Peer Group 2).⁹ In our illustrative MA–VIP model, we use eligibility for full Medicaid benefits (a Medicare beneficiary’s “dual eligibility”), as we do in the hospital value incentive program (HVIP), as a proxy for whether a plan’s enrollees are more difficult to treat. Individuals with full Medicaid benefits are much more likely than other Medicare beneficiaries to be disabled, have multiple chronic conditions, and have functional impairments. Policymakers could consider using other social risk factors to define peer groups, such as beneficiaries qualifying for the Part D low-income subsidy, disability status (which is a current adjustment factor in the MA QBP), and area deprivation indexes, with the definitions subject to refinement as more data became available. When determining the number of peer groups, policymakers will need to weigh the reporting burden (e.g., collecting a reliable sample of patient experience surveys for each group) and the ability to calculate valid measure results for smaller populations.

Establish a system for distributing rewards with no “cliff” effects

The Commission holds that Medicare quality programs should give rewards based on clear and absolute performance targets. However, as currently implemented, MA’s QBP bases bonuses solely on a comparison of results achieved among plans in each year—regardless of overall trends in performance and without assessing whether there should be an expected minimum level of performance for bonus eligibility. Plans do not know in advance whether a certain level of performance is or is not bonus-level performance for a given measure. For most of the MA star system’s measures, CMS retrospectively determines yearly star ratings based on the relative performance of all contracts over a past performance period (e.g., 2020 star ratings were determined using data that plans reported in June 2019 for the 2018 performance period). CMS uses a clustering algorithm—a method of grouping like-performing contracts—to identify “cut points” for assigning contracts to the five possible star levels for each of the measures (essentially forcing a five-group distribution). The weighted average of up to 45 individual-measure star ratings determined in this way constitutes a contract’s overall average rating (which, if at or above 3.75, will result in the bonus-level overall average rating of 4 stars or better).¹⁰ The retrospective clustering

method decreases a plan’s ability to predict what star level will be assigned to a particular measure result in each year because, for example, the cut point separating a 3-star rating from a 4-star rating can be very different each year. A plan might have achieved a 4-star rating for a measure in one year that in the following year falls in the 3-star cluster, or a plan that had no change in results (or had a decline in performance) may move from a 3-star cluster to a 4-star cluster solely because of the distribution of results in the measurement year.¹¹ This unpredictability makes it difficult for providers and plans to manage their quality improvement efforts.

Unlike the current QBP, the MA–VIP is designed to reward or penalize a plan using a continuous, prospectively set scale for each measure. The performance scale could be set for each measure using different methods. For example, the performance-to-points scale can be set based on a broad distribution of historical data so that most entities have the opportunity to earn credit for their performance. Medicare can assess the performance-to-points scale annually and, if needed, revise the scale depending on whether expectations for quality achievement are met.¹² By making this scale continuous—that is, there are no cut points that need to be crossed in order for changes in quality to register—every improvement in quality is recognized by the MA–VIP. Unlike in the all-or-nothing QBP point system, in which a plan might determine that it is unable to achieve a 4-star (bonus) rating and the plan lessens its emphasis on quality improvement, in the MA–VIP, MA plans are always better off improving quality than not because the continuous scale provides incentives to achieve as high a score as possible for each measure.¹³

Prospectively set performance targets can drive quality improvement because plans are able to see how they will be rewarded for improvements in performance on measures. Under the MA–VIP, plans would be able to predict approximate rewards, given advance knowledge of the national performance-to-points scale for each measure (i.e., how their performance on measures translates to more points) as well as the approximate payment multiplier (i.e., the conversion of points to payment adjustments) for each peer group. The MA–VIP distributes rewards and penalties within a market area, and it would be administratively complex for CMS to accurately estimate and release these prospective payment multipliers (e.g., potentially 500 market areas with at least 2 peer groups in each). However, a couple of years after

FIGURE 3-3

Illustrative example of how a plan could adjust bids and rebates if 5 percent add-on to benchmarks were to be discontinued

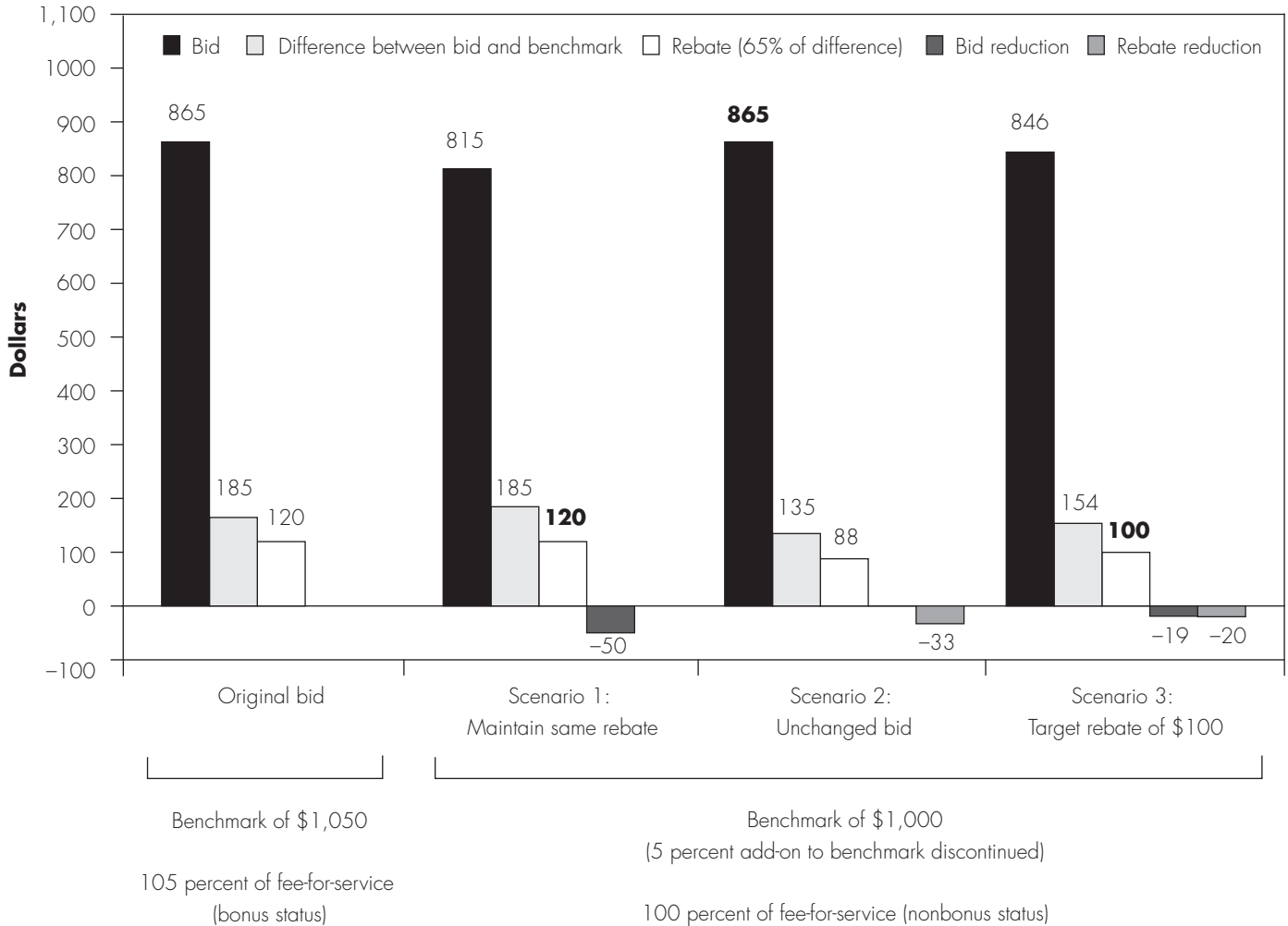

Note: Illustrative example only, which assumes a plan in bonus status with rebate level of 65 percent, bidding for a population with a 1.0 average risk score, in a geographic area with a benchmark of 100 percent of fee-for-service spending, no cap on the benchmark level and in a non-double-bonus county. Totals may not sum due to rounding.

MA-VIP implementation, plans will have a general sense of how much of a reward they can receive for improved performance.

Distribute plan-financed rewards and penalties at a local market level

The MA-VIP is designed as a system of rewards and penalties. In this section, we discuss why and how the program will be financed through a portion of plan payments and the mechanism to fund a pool of dollars to distribute as rewards and penalties.

The MA-VIP will not be financed with added program dollars

When the Commission recommended a value incentive program for Medicare health plans in 2004, it was in the form of a system in which a small share of plan payments would be used to fund a pool of dollars that would redistribute money among plans based on their relative performance on quality metrics. No program dollars would have been added to fund the quality incentive program—unlike the current MA QBP, which uses additional program dollars to fund bonus payments.

An approach consistent with the Commission's long-standing recommendation in this regard achieves greater parity between MA and FFS (including ACO) quality incentive programs. This approach also results in savings to the Medicare program—reducing Part A expenditures and preserving trust fund dollars and providing savings to taxpayers, beneficiaries, and state Medicaid programs through reduced Part B expenditures and the premiums that all beneficiaries are obligated to pay to finance Part B.

The MA–VIP would be financed in the manner originally contemplated by the Commission: Quality incentive payments would be financed through a pool funded by a share of plan payments (as is currently done for the Medicare–Medicaid financial alignment demonstration plans through a withhold of up to 5 percent of total payments). The redesigned system would be a means of imposing financial pressure on health plans to increase their efficiency.

What is the potential effect of moving from a rewards-only to a plan-financed reward or penalty program?

For plans currently benefiting from higher benchmarks because they are in bonus status, the impact of discontinuing the use of added program dollars will depend on plans' bidding behavior and how they fare financially in the MA–VIP. Reduced Medicare revenues can affect plans' administrative expenses and profits, the level of extra benefits for enrollees, or payments to the plan's providers—or a combination of these factors.

Figure 3-3 illustrates various scenarios showing the effect on bids and rebates for a geographic area in which the benchmark changes from 105 percent (bonus) to 100 percent of FFS (nonbonus). A plan can decide (1) to change the plan bid to maintain the current rebate level; (2) leave the bid unchanged, with a resulting reduction in the value of extra benefits; or (3) modify the plan bid to achieve a certain target rebate level (\$100 in our illustrative example). (Though Figure 3-3 uses illustrative numbers, the rebate dollars as well as the amounts for bids and benchmarks are close to actual averages across MA.)

In the illustrative example, if the benchmark is \$1,000 rather than \$1,050, a company could decide to keep the rebate at \$120, which would require the plan to reduce its bid by \$50 (that is, a reduction in the cost of providing care, administrative costs, or profit, or a combination thereof) or it could decide to maintain a bid of \$865, which would reduce rebates by \$33 per month. Alternatively, the company could pursue a mixed strategy of only partly

reducing its rebates and could reduce its bid by less than \$50. If the company decided to set a rebate level of \$100, it would result in \$20 less in rebates for enrollees, but the company's bid would have to decline by only \$19.

The illustrative example of Figure 3-3 does not exactly convey what happens between one year and the next; it is more a comparison of bonus plans versus nonbonus plans in a given year in a given area. That is because, year over year, MA benchmarks increase due to inflation and other cost increase factors in MA and FFS (because FFS rates determine MA rates), or the benchmark in an area could change because of the change in the FFS quartile a county is assigned. If, for example, benchmarks were to rise by 5 percent year over year and QBP bonuses were no longer available, a plan could continue a rebate of \$120 without any change to its bid. Beginning in 2021, plans will no longer be required to pay the 2 percent health insurer fee instituted by the Affordable Care Act of 2010. The fee is 2 percent of revenue (the CMS payment of the plan's bid plus the rebate dollars). In the illustrative example of Scenario 3, 2 percent of revenue would average about \$19 per member per month (2 percent of revenue of \$946 (\$846 + \$100)), meaning that in the last example, the \$19 bid reduction to arrive at a rebate of \$100 could be offset entirely by the added revenue resulting from the repeal of the health insurer fee. However, bids also change from year to year for various reasons—such as a plan's practice of passing on benchmark increases to its providers, a change in the provider network to include higher cost providers, or changes in the competitive environment that would put pressure on a plan to increase its extra benefits.

Our past analysis of actual bidding behavior suggests that plans have a strong motivation to try to avoid reductions in extra benefits while at the same time not necessarily increasing extra benefits when revenue from CMS increases. That is, declines in a plan's revenue do not result in a dollar-for-dollar decline in extra benefits, nor do increases in revenue result in dollar-for-dollar increases in extra benefits. Our previously presented analysis of the bids for 2019 shows that most of the extra dollars from bonus payments were not used to provide extra benefits to MA enrollees, and only those plans that saw a decline in their benchmarks due to the loss of bonus status reduced their costs of providing the basic Medicare benefit package (see Figure 3-4, p. 64). The text box (pp. 64–67) provides additional details about the actions plans took between 2018 and 2019 in reaction to changes in MA revenue.

Changes in bids between 2018 and 2019 show that plans reduce administrative costs and profits to maintain extra benefits

Figure 3-4 shows the change in bids and benchmarks between 2018 and 2019 based on plans' bonus status or change in bonus status. The bids and benchmarks are standardized amounts, representing amounts for a population of average risk. The "standardized bid change" amounts show the level of plans' medical inflation for the Medicare Part A and Part B benefit package (the cost of the benefit, administration, and profit). For plans that maintained the same bonus (or nonbonus) status

between 2018 and 2019, the cost of providing the Medicare benefit—including administrative costs and profit—rose by a risk-standardized 4 percent. For such plans, benchmarks increased 6 percent (for a population of average risk). For plans that had an increase in their Medicare payments because they moved from nonbonus status to bonus status, the reported cost of providing the Medicare benefit rose by 10 percent—over twice the increase for the other bonus status categories of plans shown in Figure 3-4. The

(continued next page)

FIGURE 3-4 Additional quality bonus payments resulted in higher bids, while plans losing bonus status reduced their bids for the Medicare benefit package between 2018 and 2019

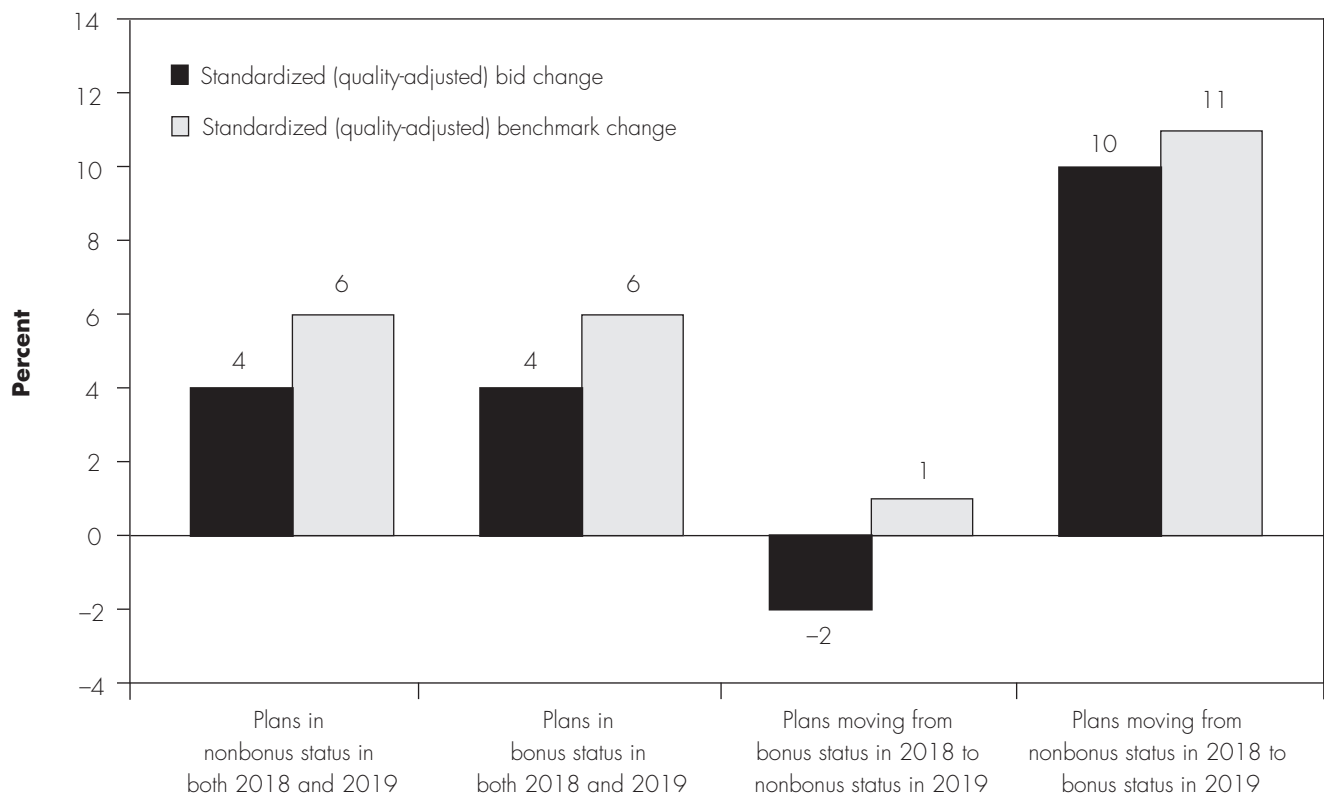

Note: Special needs plans are excluded. Excludes plans with changes in segments (subplan classifications) that materially differ between the two years. All bid data pertain to the Medicare Part A and Part B benefit package.

Source: MedPAC analysis of 2019 Medicare Advantage bid data.

Changes in bids between 2018 and 2019 show that plans reduce administrative costs and profits to maintain extra benefits (cont.)

rise in medical inflation for these plans (10 percent) nearly matched the rise in quality-adjusted benchmark levels (11 percent). In contrast, plans moving from bonus status to nonbonus status reduced their cost of providing the Medicare benefit in the face of only a small increase in the benchmark.

Table 3-3 breaks down the components of the payment changes for plans' bonus status categories, showing plans that lost bonus status did not reduce their level of extra benefits but changed other factors in their bids. The table compares (1) actual bids (not standardized for risk—i.e., representing the actual costs plans expect to incur, based on the expected risk of the plan's enrollees) against (2) benchmarks that have been risk adjusted using the plan's projection of the risk of its enrollees. The value of rebates offered when a plan

bids below the benchmark is established by comparing risk-adjusted amounts because Medicare's payments to a plan are risk adjusted (i.e., the plan's risk-adjusted payment is more or less than the Medicare base payment). The difference between the expected payment from Medicare and the expected cost of providing the benefit is the basis for determining the rebate amount.

Table 3-3 shows that, in the case of plans leaving bonus status (bonus to nonbonus), their benchmarks increased (reflecting a base benchmark increase of 1 percent) and the projected risk scores increased for these plans (risk score data not shown in table). Such plans had an enrollment-weighted benchmark increase of \$46, of which \$32 (or 70 percent) was allotted to the rebate computation, producing a monthly beneficiary

(continued next page)

**TABLE
3-3**

In 2019, for plans newly receiving bonus payments, only a small share of the benchmark financed extra benefits, but plans leaving bonus status applied most of their benchmark increase to extra benefits

	Bonus status unchanged from prior year	Plans moving from bonus to nonbonus status	Plans moving from nonbonus to bonus status
Risk-adjusted benchmark increase	\$72	\$46	\$108
Risk-adjusted bid increase	\$48	\$14	\$83
Marginal addition to rebate computation (benchmark minus the bid)	\$24	\$32	\$26
Value of extra benefits to beneficiaries (50 percent to 70 percent of rebate, based on stars)	\$16	\$21	\$17
Share of benchmark increase applied to rebates	33%	70%	24%
Components of the risk-adjusted bid increase			
Dollar change in net medical expenses	53	\$30	\$59
Dollar change in administrative costs	-\$10	-\$5	-\$10
Dollar change in Medicare margin	\$4	-\$10	\$33

Note: Special needs plans are excluded. Table excludes plans with changes in segments (subplan classifications) that materially differ between the two years. All bid data pertain to the Medicare Part A and Part B benefit package. Dollar figures are per member per month amounts. Components may not sum to totals due to rounding.

Source: MedPAC analysis of 2019 Medicare Advantage bid data.

Changes in bids between 2018 and 2019 show that plans reduce administrative costs and profits to maintain extra benefits (cont.)

rebate amount of \$21. These plans' bids increased very little (by \$14); they reduced their margins by an average of \$10 per member per month; they reduced their administrative costs; and their Medicare Part A and Part B medical expenses increased less than those of other plans (by \$30). For the two other plan categories, plans remaining in the same bonus status and plans changing from nonbonus to bonus status, a third (\$24 of \$72) or less (\$26 of \$108) of the benchmark increase was applied toward the rebate computation, respectively. In the nonbonus-to-bonus category, 30 percent of the increased benchmarks (\$33) was used to increase plan margins, and payments for Medicare-covered health care services increased. Of the three components of the bid for the Medicare Part A and Part B benefit—medical costs, administrative costs, and margin (profit)—the administrative cost component decreased for all categories shown in the table. (Because of the increase in margins, it may have been necessary to reduce administrative costs to maintain a medical loss ratio—

the share of the bid going toward medical costs—at 85 percent or less, as required of Medicare Advantage (MA) plans.) Other factors may also play a part in the differences we see in comparing 2018 bids with 2019 bids—including the type of plans involved (preferred provider organizations tend to have higher bids than HMOs) or the geographic area involved (areas with high fee-for-service (FFS) utilization tend to have lower bids in relation to area FFS levels, allowing plans to offer richer benefits). Thus, the effect of bonus funding on plans' bids in the 2018 to 2019 period may not be the same in a different period.

The illustrative example in Figure 3-3 (p. 62) shows possible plan behavior in the face of reduced Medicare revenue and the potential effect on plan bids and extra benefits. Figure 3-4 (p. 64) and Table 3-3 (p. 65) show actual plan behavior in 2019 in the face of declines or increases in revenue. The actual behavior suggests that plans will tend to maintain a similar level of extra benefits from one year to the next and will forgo profits

(continued next page)

Mechanism to fund pool of dollars to distribute as rewards and penalties

In the MA–VIP design, the mechanism to fund the pool of dollars—through which rewards and penalties would be distributed—could be structured in (at least) two ways: through a withhold of plan payments that is returned in a lump sum determined on the basis of quality performance or through a payment adjustment that would increase or decrease all plan payments by a certain percentage based on their quality performance.

If the MA–VIP were funded through a withhold, plan payments would be reduced by 2 percent, for example, for the year in which plan performance is assessed. We assume data collection would end six months after the end of the performance year, including encounter data collected through that point, and plan performance would

be converted to an MA–VIP payment amount. MA–VIP payments would redistribute the 2 percent withhold funding based on quality scores and could be sent to plans in a lump sum based on quality performance. MA–VIP payments that are smaller than a plan's 2 percent withhold would effectively be a penalty, while payments that are larger would effectively be a reward.

An alternative to the withhold approach is to use a payment adjustment mechanism, as is done in the hospital value incentive program (HVIP). Our illustrative MA–VIP model uses terms consistent with applying a payment adjustment to future plan payments. These payment adjustments would be set equal to 2 percent of plan payments, but there would be no withholding of plan payments. Instead, plan quality would be assessed during the performance year, data collection would be completed

Changes in bids between 2018 and 2019 show that plans reduce administrative costs and profits to maintain extra benefits (cont.)

if necessary but use only a portion of added revenue to finance extra benefits. Figure 3-4 (p. 64) and Table 3-3 (p. 65) show that for plans newly in bonus status (moving from nonbonus to bonus), bonus payments are not entirely used to provide extra benefits to plan enrollees. Instead, additional dollars in 2019 were used to increase margins and payments to providers. Plans whose bonus status did not change used a greater share of payment increases to apply to the rebate computation and less toward increasing their margin; the greatest share of the payment increases went toward provider payments and other components of the cost of providing the Medicare benefit (such as quality improvement activities). For plans losing their bonus status (but still receiving higher payments because of higher risk scores), the largest share (70 percent) of their increased payment was applied to maintain or improve their level of extra benefits through the rebate. In the face of financial pressure, such plans reduced their margins and reduced their cost of providing the Medicare benefit.

The current Medicare plan payment rates finance a generous level of extra benefits for enrollees, which averages \$122 per enrollee per month in 2020. We expect changing from the quality bonus program (QBP) financing method of added program dollars to an MA value incentive program financed without added program dollars would result in a relatively small decline in the record-level rebates for MA enrollees. If the added program dollars of the QBP had been discontinued in 2020 (and assuming plans made no adjustments to their bids), we computed the potential decline in rebates to be \$27—similar to the \$33 amount in the illustrative example (Figure 3-3, p. 62).¹⁴ We estimate that, stated in relation to the current level of extra benefits, if there had been a reduction of \$6 billion in available dollars, the plan behavior described in Table 3-3 (p. 65) would have resulted in a reduction in extra benefits in the range of \$6 to \$17 per member per month. For 2020, then, the average level of extra benefits would have declined from \$122 to a range of \$105 to \$116 per month—similar to, or somewhat higher than, the \$107 level of extra benefits in the preceding year, 2019. ■

and plan performance would be converted to an MA–VIP payment adjustment the next year to apply to payments the following year. The MA–VIP payment adjustments would be the net of a 2 percent funding pool, generating negative payment adjustments (penalties) and positive payment adjustments (rewards). Under this scenario, plan performance would be assessed in year 1. After a one-year lag to collect data and calculate the size of the payment adjustments (year 2), adjustments would be applied to monthly plan payments in year 3.

Distribute rewards and penalties within local market areas

With MA plan quality evaluated at the local market level, it would be possible to distribute rewards and penalties to plans either within each market or nationally. The remainder of this section reflects the Commission’s

consideration of local and national approaches to distributing rewards and penalties, concluding with the Commission’s support for distributing rewards and penalties within each local market area.

Distributing rewards and penalties within each market area means that the value of rewards equals the value of penalties in each market, and net MA–VIP payments are zero in every market area. Under this approach, for each peer group, the parent organization with the highest quality score in the market receives the greatest reward, and the organization with the lowest score in the market receives the greatest penalty. Distributing rewards and penalties this way provides an incentive for each parent organization to improve quality within the market and for each peer group in that market. Thus, plans are rewarded for their performance in each market.

**TABLE
3-4**

Comparison of favored local market distribution of MA-VIP rewards and penalties versus national distribution

Considerations	Local market distribution	National distribution
Quality improvement incentives	<i>Improve quality in every market</i>	<i>Improve quality in every market, but plan offerings may be more numerous in markets with higher average MA quality</i>
Geographic neutrality	<i>Geographically neutral: Does not favor MA plan participation in some markets over others</i>	<i>Not geographically neutral: Favors MA participation in markets with higher average quality</i>
Neutrality with FFS Medicare	<i>Maintains neutrality: Neither MA nor FFS Medicare is favored in any market</i>	<i>Does not maintain neutrality: Favors MA in high MA quality markets and favors FFS in low MA quality markets, both without regard to FFS quality in those markets</i>
Alignment with beneficiary plan options	<i>Aligned with beneficiary plan options: Best-performing plans receive rewards and worst-performing plans receive penalties in each area</i>	<i>Partially aligned with beneficiary plan options: Performance in relation to a national standard means that worst-performing plans in an area may receive rewards and best-performing plans may receive penalties</i>
Plan accountability for exogenous market conditions	<i>Plans are not accountable for market conditions outside their control: Plans are not held accountable for exogenous market conditions</i>	<i>Plans are accountable for market conditions outside their control: Plans are held accountable for exogenous market conditions</i>
Alignment of rewards with local or national quality performance	<i>Rewards aligned with local market performance: Quality scores reflect plans' effectiveness at improving quality in each market</i>	<i>Rewards aligned with national performance: Quality scores reflect plans' effectiveness at improving quality in each market but also the underlying market conditions that affect average MA quality nationally</i>
Plan administrative burden to track performance	<i>Low performance-tracking burden: Plans track only a few MA competitors within their local market to assess relative performance and calibrate quality goals</i>	<i>High performance-tracking burden: Plans track all MA competitors in the country to assess relative performance and calibrate quality goals</i>

Note: MA-VIP (Medicare Advantage value incentive program), FFS (fee-for-service).

Distributing rewards and penalties at the market-area level holds constant the market conditions that are outside of a plan's control (e.g., availability of safety net programs like Medicaid and food assistance, transportation infrastructure, the level of social risk factors in the population, and the underlying organization of providers in each market). National distribution would hold plans accountable both for their performance and for local market conditions. In addition, national distribution could result in rewards for all plans in some markets and penalties for all plans in other markets because payments would be redistributed from markets with lower MA quality to markets with higher MA quality. Over time, increased payments in markets with higher average

MA quality and decreased payments in markets with lower average MA quality could skew the geographic distribution of plan offerings.

The Commission's HVIP distributes rewards and penalties nationally, meaning a pool of dollars is distributed to hospitals based on their quality performance, regardless of the hospital's location. Under this approach, rewards and penalties may not be distributed evenly across the country. In contrast to hospitals, MA plan sponsors can change the markets in which they operate each year. Because of this flexibility and certain benefits described below (e.g., not holding plans accountable for exogenous market conditions, not favoring MA or FFS in any market,

better aligning with beneficiary plan options, and lower administrative burden for plans tracking performance), we designed the MA–VIP to distribute rewards and penalties by market. Table 3-4 provides a comparison of the differences between local market–level and national distribution of rewards and penalties. The Commission also considered (but did not recommend) a blended market level–national approach that would enable a share of the rewards to be distributed to the highest performing plans in the market from a local reward pool financed by a portion of all plan payments in the market area. Under the blended approach, the remaining share of rewards would be distributed from a national pool of dollars financed by a portion of all plans’ payments across the country.

The Commission has maintained a standard of not favoring either the MA program or FFS Medicare with respect to their payment systems or monitoring and compliance activities. Ideally, we would compare MA plan quality with local FFS quality in each market and reward MA plans that provide higher quality than FFS in the area. However, such a comparison between MA and FFS is currently not feasible.¹⁵ Distributing MA–VIP rewards and penalties by market does not favor either the MA program or FFS Medicare because all MA–VIP plan rewards and penalties are confined within each market, having a zero-dollar net effect in every market. In contrast, national distribution of rewards and penalties favors the MA program in markets with high average MA performance and favors FFS Medicare in markets with low average MA performance, regardless of whether the MA performance is better than local FFS performance. Some or all MA plans in markets with low average quality may offer higher quality than local FFS Medicare, yet those plans would receive a penalty under national distribution. Conversely, MA plans performing below local FFS in markets with high average quality would receive a reward under national distribution. Until FFS comparisons are possible, distributing rewards and penalties within each market maintains neutrality between the two programs.

Medicare beneficiaries generally do not move their residence to a different market on the basis of their local Medicare FFS and plan options. Distributing rewards and penalties by market aligns MA–VIP payments with the best MA plan options in each market, providing a payment increase to the best MA performers and payment decrease to the worst performers. Distributing rewards and penalties nationally maintains MA plan performance in each market as the basis of evaluation, but could provide rewards to

the worst performing plan options or penalties to the best performing plan options available to beneficiaries in a given market.

MA quality scores are a function of factors under the plan’s control (e.g., provider network management and incentive programs) and market conditions outside an MA plan’s ability to control (such as the availability of safety net programs like Medicaid and food assistance). Factors within a plan’s control can differentiate plan quality scores within a market, but market conditions outside a plan’s control tend to explain why average MA quality varies across markets, including differences in average MA quality in markets with the same set of parent organizations. Our initial modeling shows wide variation in average MA quality across markets (see Figure 3-5, p. 80, and Figure 3-6, p. 81). Distributing rewards and penalties within each market would not hold plans accountable for market conditions that are outside of their control, and differences between parent organization quality scores within each market would generally reflect plans’ effectiveness in improving quality in that market. Distributing rewards and penalties nationally would hold plans accountable for factors outside their control, and differences in quality scores would jointly reflect differences in market conditions and differences in plans’ effectiveness in improving quality in a given market.

Aside from the question of accounting for differences in market factors, a further consideration is whether rewards and penalties should be tied to a plan’s local performance or the plan’s performance in relation to a national standard. This consideration does not involve whether performance results should be reported locally or nationally, but whether local or national performance is more justified as a basis for distributing rewards and penalties. For example, if rewards and penalties were distributed locally, some parent organizations with quality scores above the national average would receive a penalty for performing below average in their market, while some parent organizations with quality scores below the national average would receive a reward for performing above average in their market. The level at which rewards and penalties are distributed determines whether plans are held accountable for local market conditions outside of their control. If plans are held harmless for exogenous factors that exist in their local markets, as with local distribution of rewards and penalties, the perceived misalignment of rewards and penalties across markets is not a concern (plan performance is assessed in comparison to local

plans operating under the same market conditions). Conversely, if plans are judged on all factors affecting their quality score including market conditions outside their control, as with national distribution, then rewards and penalties would be aligned across markets, but in such a case, the use of national standards for determining rewards and penalties should be weighed against the other considerations noted in Table 3-4 (p. 68).

A final consideration is the ability of plans to track their performance and assess any MA–VIP rewards or penalties. Plans attempting to track and set goals for MA–VIP rewards or penalties will track not only their own performance but also the performance of competitors. When MA–VIP rewards and penalties are distributed by market, the burden of performance tracking is relatively low because competition is limited to the other plans in the same market; however, this burden increases when distributing MA–VIP rewards and penalties nationally, as competition encompasses every plan in the country. Applying a local and national blend to distribute rewards and penalties would impose the highest burden, requiring plans to track their local performance and national performance.

The Commission assessed the merits of using a blended approach in which a share of a plan’s ultimate reward or penalty would be based on a nationally distributed pool of dollars, while the rest would be based on a pool of dollars distributed within the plan’s local market. The relative size of the national pool and market pools of dollars would be determined by weighting the local and national components of the blend. The overall reward or penalty for a parent organization in a given market would depend on the weight of each component as well as the relative magnitude of rewards and penalties garnered by the plan from the national pool and from the local market pool. Under a blended approach, a plan with above-average quality performance in its market but below-average quality performance nationally would receive a reward for its high market-area quality performance and a penalty for its low national quality performance.

The Commission generally does not support a blended approach, which would share the attributes of both a local and national approach: It would not maintain geographic neutrality or neutrality between MA and FFS programs (features of a pure local approach); it would not align rewards and penalties with beneficiary local plan options (local performance) or national performance; it would hold plans partially accountable for market conditions outside

their control; and it would require the greatest complexity for plans to assess their performance, by requiring them to assess their local performance and their national performance. Given these considerations, the Commission supports the distribution of rewards and penalties within each local market over a national approach.

Illustrative scoring and payment adjustments under the MA–VIP model

To analyze potential MA plan performance under the MA–VIP design, we modeled scoring and calculating payment adjustments in a subset of market areas based on currently available data. To account for differences in the social risk factors of plan populations, within each market area, we stratified each parent organization’s enrolled population into two peer groups: fully dual-eligible enrollees and all other enrollees. We converted the performance of each MA plan peer group to an MA–VIP payment adjustment that converts to a reward or penalty. (See text box on converting quality performance to rewards or penalties, pp. 72–73.) For many market areas, we do not have sufficient data that would allow us to calculate MA plan performance on the full set of our MA–VIP model measures; however, our model results show that the MA–VIP design elements can feasibly be incorporated into a redesigned and improved quality incentive program to replace the QBP. Also, as intended in the design of the MA–VIP methodology, the peer group with more social risk factors receives a relatively higher reward for higher quality. The modeling results also demonstrate that, as compared with the QBP, the MA–VIP reduces the disparity between fully dual-eligible enrollees and other populations when determining how financial incentives are distributed.

Calculate plan performance on a small set of measures

We modeled the MA–VIP using MA plan performance on 6 of the 12 measures presented in the illustrative measure set in Table 3-2 (p. 58). We were limited in the data available to calculate meaningful (reliable) measure results for the MA–VIP reporting unit (parent organization in a market area) because MA quality measurement is currently done at the contract level and some contracts span multiple market areas.

The lack of complete MA encounter data also limits the administrative data–based measures we can include in

the MA–VIP model. The Commission has previously recommended that, given the value of complete encounter data, CMS should improve plan performance metrics to include assessments of data completeness, implement a payment withhold to introduce the financial incentive to submit complete and accurate data, and require submissions of providers’ claims directly to Medicare administrative contractors if encounter data performance thresholds are not met (Medicare Payment Advisory Commission 2019b). Through its consideration of the recommendation, the Commission expressed broad support for using the encounter data in many applications to improve incentives for increasing the completeness and accuracy of the data.

For ACS hospitalizations, we can supplement inpatient encounter data with MA inpatient data reported in the Medicare Provider Analysis and Review (MedPAR) file.¹⁶ However, for ACS ED visits, there is no other data source to supplement outpatient encounter data, so we determined that we cannot measure ACS emergency department visits at this time.¹⁷ We did not include the readmissions measure in the model because of technical issues converting the encounter data that would be used to calculate risk-adjusted readmissions results.

For the six measures that we can include in our MA–VIP model, we calculated measure results for each reporting unit (parent organization in a market area and, where relevant, peer group) using four available data sources: (1) encounter data MA plans submit to CMS supplemented with other administrative data sources (i.e., MedPAR hospital inpatient data reported by hospitals on all Medicare FFS and MA inpatient stays); (2) beneficiary-level patient-reported outcomes data from the HOS (collected by certified survey vendors on behalf of plans); (3) beneficiary-level patient/enrollee experience data from CAHPS surveys (collected by certified survey vendors on behalf of plans); and (4) beneficiary-level data on HEDIS measures that plans submit to CMS. The measure calculations are based on existing Commission, CMS, or HEDIS measure specifications. We also applied existing CMS or industry minimum sample sizes to determine whether a reporting unit had complete performance results. Table 3-6 (p. 74) summarizes the measure calculations used in our MA–VIP model.

To increase the number of observations in our model, we pooled three years of data (2015 to 2017) for most of our measure calculations. This amount of data was especially

important to increase the number of reporting units that would meet the minimum sample sizes for surveys to be scored in MA–VIP modeling since we use beneficiary-level survey responses that are based on a sample of enrollees at the contract level and rescore them into results for the MA–VIP reporting units based on where the enrollee resides. (Under the MA–VIP, each parent organization meeting a minimum enrollment threshold in a market area would be required to work with a third-party survey vendor to collect CAHPS and HOS responses from enrollees at the market-area level, as opposed to the contract level.)

In implementing the MA–VIP, policymakers will need to determine how many years of data to use in measure calculations. Using the most recent year of data holds MA plans accountable for the quality of their most recent care provided to enrollees and is likely a better predictor of the quality of care in the subsequent year. Using measure results based on multiple years of data reduces random variation from smaller sample sizes and allows Medicare to measure the quality of care for low-volume plans. However, to reward performance that improved (or declined) over the multiple-year period, the model could weight recent-year performance more heavily than performance in earlier years. The model could also use the most recent year of data for plans that meet minimum sample size requirements and multiple years for those that do not meet the minimum sample size in the most recent year. One disadvantage of this approach is that small plans would be held accountable for their performance through multiple years, while large plans would be held accountable for only one year of performance, which could be perceived as applying different accountability standards to small versus large plans.

The key components of our model calculate performance within a local market area with stratified scoring and separate pools of dollars for fully dual-eligible enrollees and all other enrollees. Thus, we calculate separate measure results for a reporting unit’s fully dual-eligible population and all-others population. Consistent with the Commission’s principles for quality measurement, the specifications for the ACS hospitalization measure we developed do not include social risk factors (such as dual eligibility for Medicare and Medicaid) in the risk adjustment model. Therefore, we calculate ACS hospitalization results for both peer group populations of each reporting unit that meets the minimum sample size requirement (i.e., 150 fully dual-eligible enrollees and 150

Using peer groups to convert quality performance to rewards or penalties in a local market area

In the following example, a local market area has three Medicare Advantage (MA) parent organizations (referred to in this example as “three MA plans”) for which to calculate performance measure results. We stratify each plan’s enrollee population into two peer groups: fully dual-eligible enrollees (Peer Group 1) and all other enrollees (Peer Group 2). Following several steps, we convert each of the MA plans’ peer group quality measure performance to a payment adjustment and combine the peer groups’ payment adjustments into one total Medicare Advantage value incentive program (MA–VIP) adjustment. Specifically, we followed six steps:

Step 1: For each peer group, calculate each MA plan’s performance on the quality measures; this step produces a performance rate for each plan’s peer groups for each measure. The calculations are based on either beneficiary-level administrative data or survey data.

Step 2: Convert each MA plan’s performance on the quality measures for each peer group to points based on the same continuous performance-to-points scale (nationally determined).

Step 3: Calculate the weighted average of each MA plan’s points on the quality measures to determine total MA–VIP points for each peer group. (Assume higher weighting for outcome measures.)

Step 4: For each peer group, create a pool of expected MA–VIP payments to plans, based on a specified percentage tied to plan payments for each peer group (e.g., 2 percent of each plan’s payments for their peer group’s population).

Step 5: For each peer group, calculate the payment multiplier or percentage adjustment to payment per MA–VIP point, which converts total MA–VIP points to dollars and results in spending each group’s pool of dollars defined in Step 4.

Payment multiplier = MA–VIP pool for peer group / sum of (each MA plan’s payment tied to the peer

group × each MA plan’s total MA–VIP points for the peer group)

Step 6: Compute each MA plan’s adjustment for the coming year based on past performance and its peer groups’ payment multiplier.

MA plan’s total MA–VIP adjustment = (Peer Group 1 payment multiplier × MA plan’s total MA–VIP points for Peer Group 1) + (Peer Group 2 payment multiplier × MA plan’s total MA–VIP points for Peer Group 2)

Table 3-5 illustrates the conversion of MA–VIP points to payment adjustments using peer grouping in a local market area with three MA plans that have different numbers of fully dual-eligible and other enrollees. We calculate quality measure results based on administrative and survey data for each plan’s fully dual-eligible enrollees (Peer Group 1) and all other enrollees (Peer Group 2) for each of the five measure domains. Using the same nationally determined continuous performance-to-points scales, we convert each peer group’s quality performance to points for each domain. We average each plan’s performance by peer group to determine MA–VIP total points for each plan’s peer groups. The table shows that MA Plan A earns the highest performance across both peer groups (8 points). MA Plans B and C both earn lower points for their fully dual-eligible population (4 points) compared with their other-enrollee population (6 points).

We create a pool of dollars based on 2 percent of each of the MA plan’s payments tied to each of the peer groups. Since MA Plan C has the largest number of enrollees, its contribution to the pool of dollars is largest. The pool to be redistributed for Peer Group 2 (other enrollees) is larger than Peer Group 1’s pool because more enrollees and payments are in Peer Group 2. For each peer group, we calculate a payment multiplier or percentage adjustment to payment per MA–VIP point. The payment multiplier for each peer group is the group’s pool of dollars divided by the

(continued next page)

Using peer groups to convert quality performance to rewards or penalties in a local market area (cont.)

sum of each plan's total payments times their MA–VIP total points. Because Peer Group 1 has a larger point multiplier than Peer Group 2, the plan with higher performance for its fully dual-eligible enrolled population can earn a higher reward.

We calculate payment adjustments based on each peer group's MA–VIP points and payment multiplier. In total, MA Plan A has the highest performance for both

peer groups and so earns a reward of 1.21 percent, net of its 2 percent of payment that went into the pool. On net, MA Plan A earns a reward of \$3.5 million for Peer Group 1 and a reward of \$1.3 million for Peer Group 2, for a total reward of \$4.8 million. MA Plans B and C both receive small penalties because they receive fewer points for both their fully dual-eligible enrollees and all other enrollee populations. The entire pool of dollars is distributed to the MA plans in the market. ■

**TABLE
3–5**

Converting MA–VIP points to payment adjustments in a local market area: An illustrative example

	Peer Group 1 (fully dual-eligible beneficiaries)			Peer Group 2 (all others)		
	Plan A	Plan B	Plan C	Plan A	Plan B	Plan C
Number of beneficiaries	10,000	100,000	54,000	20,000	620,000	820,000
MA–VIP total points (Steps 1–3)	8	4	4	8	6	6
Plan payments tied to each peer group's beneficiaries	\$200M	\$2,000M	\$1,080M	\$200M	\$6,200M	\$8,200M
2 percent of plan payments tied to each peer group's population	\$4M	\$40M	\$21.6M	\$4M	\$124M	\$164M
Total pool of dollars for peer group (Step 4)		\$65.6M			\$292 M	
Payment multiplier for peer group [group's pool / sum (plan payments × points)] (Step 5)		0.47%			0.33%	
MA–VIP payment adjustments [points × multiplier] (Step 6)	3.77%	1.89%	1.89%	2.65%	1.99%	1.99%
MA–VIP payments [multiplier × plan payments]	\$7.5M	\$37.7M	\$20.4M	\$5.3M	\$123.4M	\$163.3M
Net payments	\$3.5M	–\$2.3M	–\$1.2M	\$1.3M	–\$0.6M	–\$0.7M
Total MA–VIP payment adjustment (net after 2 percent of payment)						
Plan A			+1.21% (+\$4.8M)			
Plan B			–0.03% (–\$2.9M)			
Plan C			–0.02% (–\$2.0M)			

Note: MA–VIP (Medicare Advantage value incentive program), M (million). This example assumes a local market area has three Medicare Advantage plans. Fully dual-eligible beneficiaries qualify for a full range of Medicaid benefits. MA–VIP total points range from 0 to 10 points. Totals may not sum to components due to rounding.

**TABLE
3-6**

Illustrative MA-VIP model: Calculating performance on a small set of available measures

Domain	ACS hospital use	Patient-reported outcomes	Patient/enrollee experience	Staying healthy and managing long-term conditions
Measures	ACS hospitalizations	Improved or maintained physical health status Improved or maintained mental health status	Getting needed care Rating of health plan	Breast cancer screening
Years / time period	2015–2017	One time period: change between 2015–2017	2015–2017	2015–2017
Minimum sample size	150 enrollees ^a	30 completed enrollee surveys ^b	100 completed enrollee surveys ^c	30 women meeting inclusion criteria ^d
Risk or case-mix adjustment	Risk-standardized rates based on method developed by RTI International for the Commission	CMS HOS case-mix adjustment	CMS CAHPS [®] case-mix adjustment	Not adjusted
Modeling data sources	Encounter data, MedPAR	Beneficiary-level HOS survey data	Beneficiary-level CAHPS survey data	Beneficiary-level HEDIS [®] data
Stratification	Fully dual eligible All others	None	None	Fully dual eligible All others

Note: MA-VIP (Medicare Advantage value incentive program), ACS (ambulatory care-sensitive), MedPAR (Medicare Provider Analysis and Review), HOS (Health Outcomes Survey), CAHPS[®] (Consumer Assessment of Healthcare Providers and Systems[®]), HEDIS[®] (Healthcare Effectiveness Data and Information Set[®]). “Minimum sample size” is the number of observations required across the years included or time period to be included in the MA-VIP model. The MA-VIP calculates stratified scoring for two groups (fully dual-eligible enrollees and all other enrollees). The MA-VIP scores the ACS hospitalization and breast cancer screening measures with separate rates for each of the groups, but the same rate across both groups for the two survey-based measure domains because case-mix adjustment factors address group differences.

^a Based on minimum sample size for similar HEDIS measure.

^b CMS statement regarding minimum sample to determine differences among plans.

^c RAND-determined minimum sample size for health plan CAHPS.

^d National Committee for Quality Assurance HEDIS measure-specific minimum (e.g., women ages 50–74).

non-fully dual-eligible enrollees for ACS hospitalizations). For the two survey-based measure domains (CAHPS and HOS), the CMS methodology includes eligibility for Medicaid in the case-mix adjustment. We therefore use the result based on the entire MA population to determine the score for both peer groups in the reporting unit. For example, a reporting unit’s result of 65 percent on the HOS “improved or maintained physical health” measure based on a sample of all MA enrollees would apply to MA-VIP scoring in both groups. CMS has identified differences between breast cancer screening (BCS) rates between the two populations, so we also calculated a separate BCS rate for each group.

For the patient-reported outcome measures, we followed CMS’s method of producing case-mix-adjusted HOS measure results to determine the share of enrollees showing maintenance or improvement of their physical health and mental health. (Enrollees were surveyed in 2015 and again in 2017 to determine changes in health status for those remaining in the same MA contract over the two-year period.) CMS currently collects survey responses from a sample of enrollees selected at the contract level, not at the parent organization and market-area levels. When one contract’s service area consists of counties in two noncontiguous states, such as Hawaii and Iowa, the HOS results for that contract are based

on a sample of enrollees residing in Hawaii and Iowa. In contrast, under the MA–VIP model, we mapped individual enrollee HOS results, which include person-level identifiers, to a local market area using the enrollee’s county of residence and to a parent organization using the enrollee’s plan identifier. To be included in the MA–VIP model, a parent organization in a market area must have 30 or more beneficiaries with HOS results attributed to the organization. Based on the survey responses attributed to an MA–VIP reporting unit, we calculated case-mix-adjusted HOS measure results (e.g., improved or maintained physical and mental health status) for each reporting unit.

We used 2015 to 2017 beneficiary-level CAHPS survey responses to calculate case-mix-adjusted patient experience results for each MA–VIP reporting unit. As with the HOS, CMS currently collects survey responses from a sample of enrollees selected at the contract level, not at the parent organization and market-area level. Thus, for the MA–VIP model, we mapped individual enrollee CAHPS surveys to a local market area using the enrollee’s county of residence and to a parent organization using the enrollee’s plan identifier. To be included in the model, a parent organization in a market area would have to have 100 or more surveys attributed to it. Based on the survey responses attributed to an MA–VIP reporting unit, we calculated case-mix-adjusted CAHPS measure results (e.g., getting needed care, rating of health plan) for each reporting unit.

Identify market areas and parent organizations to be included in the MA–VIP

Our MA–VIP model’s unit for assessing plan quality and payment adjustments is the MA parent organization in the local market area. Parent organizations are identified by CMS as reported by plans (e.g., United, Aetna, Kaiser Permanente, Anthem) and include national and regional plans. We use MedPAC market areas in our MA–VIP model.

Estimated number of market areas with sufficient parent organization enrollment to be included in the MA–VIP when implemented

To estimate how many local market areas would have sufficient parent organizations that meet enrollment requirements to calculate the illustrative MA–VIP measure set, we defined market areas as the roughly 1,200 MedPAC market areas designed to reflect local health care markets using 2017 MA plan enrollment data.¹⁸ To be included

in the model, each reporting unit (parent organization and market area) and peer group (where applicable) needed to meet the minimum sample size requirements identified in Table 3-6. For the HOS and CAHPS results, CMS would have to adapt MA–VIP requirements for fielding those surveys. An option is to apply a minimum sample of 600 to each reporting unit based on CMS’s current requirement that any contract with at least 600 enrollees must collect CAHPS results and a minimum of 500 enrollees must collect HOS results. Applying this requirement to each reporting unit (parent organization and market area combination) would likely increase the total number of surveys required, compared with the current number. However, MA plans currently field more than the minimum number of required surveys because they seek to oversample certain populations. Because the measure domains using HOS and CAHPS data do not use peer groups, the requirement to field the surveys would be 600 enrollees in each market area, regardless of full dual-eligibility status.

To determine the feasibility of applying the proposed reporting units to the MA–VIP model, we calculated the number of reporting units that meets the 600-enrollee requirement and the share of MA enrollment included in those reporting units.¹⁹ Table 3-7 (p. 76) shows the number of market areas with 0, 1, 2, and 3 or more parent organizations meeting the 600-enrollee requirement.

To implement the MA–VIP, we believe three parent organizations are necessary in a market area to ensure adequate comparison and distribution of rewards and penalties. Table 3-7 (p. 76) shows that there are 481 market areas with at least 3 parent organizations that meet a minimum sample of 600 enrollees; enrollment in those parent organizations accounts for 89 percent of MA enrollment. Our model’s minimum of 3 parent organizations excludes 749 market areas (generally nonmetropolitan areas), accounting for about 11 percent of MA enrollment, from the model’s bonus program, without a policy to include additional market areas.

Table 3-7 (p. 76) shows that 270 market areas have no parent organizations meeting the minimum enrollment of 600, covering 4 percent of current MA enrollment. It is not possible for the MA–VIP to operate in these markets. However, alternative approaches could be considered to include more of the 479 areas with only 1 or 2 parent organizations meeting the minimum enrollment of 600. One option is to combine market areas with too few parent organizations meeting the minimum criteria with

**TABLE
3-7**

Illustration of the number of parent organizations in MedPAC market areas that met related MA enrollment requirements, 2017

Category of market areas	Number of MedPAC market areas	Share of:		
		Total fully dual-eligible MA enrollment	All other MA enrollment	Total MA enrollment
Reporting units that met the 600-enrollee requirement for illustrative MA-VIP				
3 or more parent organizations	481	90.0%	88.6%	88.8%
2 parent organizations	233	3.5	5.5	5.3
1 parent organization	246	1.1	2.0	1.9
0 parent organizations	270	5.4	3.9	4.0
Total	1,230	100	100	100

Note: MA (Medicare Advantage). There are 1,230 MedPAC market areas designed to reflect health care markets. Parent organizations are the companies that operate the MA plans. We applied a minimum sample of 600 enrollees to the parent organizations based on CMS's current requirement that any plan with at least 600 enrollees must collect Consumer Assessment of Healthcare Providers and Systems[®] data and with at least 500 enrollees must collect Health Outcomes Survey results. Share of enrollment is based on the MA enrollment in the parent organizations in market areas that meet the category's criteria.

Source: MedPAC analysis of 2017 MA enrollment data.

contiguous market areas to meet the minimum three or more parent organizations with sufficient enrollment. For example, we could combine 499 Parent Organization A enrollees in X market area with the neighboring 11,200 Parent Organization B enrollees in Y market area for quality measurement and distributing MA-VIP rewards and penalties. Alternatively, the minimum number of parent organizations in a market area could be set at two. However, allowing only two parent organizations in a market area would consistently result in a direct transfer of dollars distributed from the worse performing parent organization to the better performing parent organization in that market area.

Number of market areas with sufficient quality results to be included in the MA-VIP model

Our model is also limited by the number of reporting units with sufficient data. Specifically, we are limited by the current availability of the HOS and CAHPS survey measures because the surveys are currently collected at the contract level and not at the parent organization and market-area level. Given this limitation, fewer parent organizations and market areas are included in our MA-VIP model.

After applying all criteria, our model includes 61 MedPAC market areas and 78 unique parent organizations for a total

of 258 reporting units (parent organization and market area combinations). On average, each market area includes about 4 parent organizations, ranging from 3 to 12 parent organizations in a market area. Using enrollment data from 2015 to 2017, these 61 areas represent about 40 percent of current MA enrollment (45 percent of fully dual-eligible enrollees and 39 percent of all other enrollees).

Convert performance on a small set of measures to MA-VIP points

Unlike the current QBP, which scores plans' performance on quality relative to other plans' performance scores, which are unknown until CMS applies the scoring, the MA-VIP is designed to reward or penalize a plan based on the plan's performance relative to prospectively set performance-to-points scales for each measure domain. For our MA-VIP model, we calculated each MA plan's performance (in the 61 market areas that met our criteria) on the 6 measures in the 4 measure domains we can include in the model. Using those results, we created a national performance-to-points scale for each measure. For the proposed MA-VIP model, we set the performance scale along a broad distribution of national historical data so that most plans would have the opportunity to earn points. We set the continuous points scale using a beta distribution, which helps to smooth the extremes of

**TABLE
3-8**

Illustration of point system to score performance under our illustrative MA-VIP model

Measure domains and measures

	ACS hospital use	Patient-reported outcomes		Patient/enrollee experience		Staying healthy and managing long-term conditions
	Risk-standardized rate of ACS hospitalizations per 1,000 MA enrollees (lower is better)	Improving or maintaining physical health status (higher is better)	Improving or maintaining mental health status (higher is better)	Getting needed care (higher is better)	Rating of health plan (higher is better)	Breast cancer screening (higher is better)
0 points	97	52%	73%	71%	76%	42%
2 points	59	61	80	81	82	63
4 points	49	64	82	84	84	69
6 points	41	67	84	87	86	74
8 points	33	70	86	89	88	80
10 points	16	77	90	95	92	92

Note: MA-VIP (Medicare Advantage value incentive program), ACS (ambulatory care-sensitive). Each of the six measures in the MA-VIP model is scored from 0 to 10 points; only a subset of points is displayed here. The national performance-to-points scale is based on the performance of the 258 parent organizations' peer groups in the 61 market areas with sufficient data to include in the model. The performance-to-points scales are set using a beta distribution. MA plans would technically receive only 10 points or 0 points with the best possible or worst possible scores, respectively.

Source: MedPAC analysis of MA quality data, 2015-2017.

a distribution by providing estimates of a true percentile independent of associated problems such as ceiling effects. MA plans earn up to 10 points for their performance on each of the 6 quality measures based on a continuous scale (see text box on reporting quality information, p. 59). Because Medicare is a national program, we score each plan's results against the same national performance-to-points scales, but a pool for dollars would be based on payments inside a market area and be given as rewards and penalties within that market area.

Table 3-8 presents a subset of our model's performance-to-points scale. The scales are set using historical data from the model's 258 reporting units. For example, the reporting unit in the lowest percentile of performance for the ACS hospitalization measure had a score of 97 ACS hospitalizations per 1,000 MA enrollees, which is set equal to 0 points. The reporting unit in the highest percentile of performance for that measure had a rate of 16 ACS hospitalizations per 1,000 MA enrollees, which

is set equal to 10 points. The MA-VIP scores each plan's peer group against the national standards. If a plan's peer-group ACS hospitalization score was about 33 ACS hospitalizations per 1,000 MA enrollees, it would earn about 8 points on that measure domain.

For each parent organization's peer group, we calculated a total MA-VIP score, which is a weighted average of the number of points earned for each domain. We followed CMS's QBP weighting approach with the most weight (factors of 3) given to the outcome domains (ACS hospital use and patient-reported outcomes), second highest weight (factor of 2) to the patient experience domain, and lowest weight (factor of 1) to the process measure (breast cancer screening).

Table 3-9 (p. 78) presents the average points across the peer groups in the 258 reporting units for the model's available measures. To convert performance to points for each peer group, we applied the national performance-to-points scale shown in Table 3-8 to each reporting unit.

**TABLE
3-9**

Illustrative average MA-VIP points for each peer group

MA-VIP points, by measure domains and measures

Peer group	ACS hospital use	Patient-reported outcomes		Patient/enrollee experience		Staying healthy and managing long-term conditions	Total MA-VIP
	Risk-standardized rate of ACS hospitalizations per 1,000 MA enrollees	Improving or maintaining physical health status	Improving or maintaining mental health status	Getting needed care	Rating of health plan	Breast cancer screening	
Fully dual-eligible enrollees (Peer Group 1)	3.5	5.0	5.1	5.1	4.9	3.5	46
All other enrollees (Peer Group 2)	6.4	5.0	5.1	5.1	4.9	6.6	54

Note: MA-VIP (Medicare Advantage value incentive program), ACS (ambulatory care-sensitive). Each measure in the MA-VIP model is continuously scored from 0 to 10 points. The national performance-to-points scale is based on the performance of the 258 parent organizations' peer groups in the 61 market areas with sufficient data to include in the model. The model scores two peer groups, one based on the quality of care provided to fully dual-eligible enrollees and one for all other enrollees.

Source: MedPAC analysis of MA quality data, 2015-2017.

The fully dual-eligible peer groups produced fewer points on average than the all-others peer groups on the ACS hospitalizations measure (3.5 points vs. 6.4 points) and on the BCS measure (3.5 points vs. 6.6 points), which is expected based on previous analyses of the BCS measure. The differential in the peer groups' performance supports the use of applying stratified payment adjustments to account for the social risk factors of plan populations. It is important that measure results not be adjusted because the differences in plan performance for the two populations could result from the problem that the fully dual-eligible population is more difficult to treat and manage or that plans covering those populations do not provide as high-quality care.

The patient-reported outcomes and patient/enrollee experience measures are survey based and are already case-mix adjusted for fully dual-eligible status, so a score based on a sample of the entire MA enrollment population is applied to both peer groups for MA-VIP scoring. On average, reporting units received 5.0 and 5.1 points for the patient-reported outcome measures and 5.1 and 4.9 on the patient/enrollee experience measures.

Converting MA-VIP points to payment adjustments using stratification into peer groups

Consistent with the Commission's principle that quality incentive programs should account for differences in providers' populations as needed, including social risk factors, our MA-VIP model stratifies the market-level populations it scores and redistributes pools of dollars for two peer groups: fully dual-eligible enrollees (Peer Group 1) and all other enrollees (Peer Group 2). The model uses eligibility for full Medicaid benefits, as in the HVIP, as a proxy for whether a plan's enrollees are more difficult to treat because these Medicare beneficiaries are much more likely than others to be disabled, have multiple chronic conditions, and have functional impairments. Policymakers should consider using other social risk factors to define peer groups, such as receiving the low-income drug subsidy, disability status (which is a current adjustment factor in the MA QBP), and area deprivation indexes, with the definitions subject to refinement as more data become available.

In each of the 61 market areas, for each of the 2 stratifications of enrollees, we created a pool of expected MA–VIP payments to plans based on 2 percent of each plan’s payments for its enrollees in that stratification. (As discussed earlier in the chapter, the percentage of plan payments that are used to create the pool of dollars could increase over time, and policymakers should consider the appropriate amount to incentivize quality improvement.) We also calculated the payment multiplier, or the percentage payment adjustment per MA–VIP point, which converts total points to dollars and results in spending each peer group’s pool of dollars. On this basis, we computed each plan’s MA–VIP payment adjustment by multiplying the peer group’s payment multiplier by the peer group’s total points earned.

In this way, the MA–VIP accounts for differences in social risk factors of plan populations and allows plans potentially to earn more rewards for higher quality care for their fully dual-eligible population than under the current QBP, owing to a higher payment multiplier for the fully dual-eligible enrollee peer group. This peer group on average has lower performance on quality measures, so when calculating a multiplier to redistribute a peer group’s pool of dollars, the multiplier will be higher than for the all-others peer group, which has higher MA–VIP points on average. In our MA–VIP model, we found that 93 percent of the market areas had higher percentage payment adjustments per quality point multipliers for the fully dual-eligible peer group.²⁰ These peer groups had a median payment multiplier of 0.42 percent (range: 0.30 percent to 0.74 percent); the all-others peer groups had a lower median payment multiplier of 0.35 percent (range: 0.23 percent to 0.50 percent). Thus, as intended, in the vast majority of market areas included in our model, plans have the potential to earn more points for high-quality care provided to their fully dual-eligible population.

Distribution of rewards and penalties by local market area and peer group

The MA–VIP will distribute rewards and penalties within each local market. However, for the Commission’s consideration, we produced results based on a national distribution of rewards and penalties (see text box illustrating a national distribution, pp. 82–83). For a discussion of the merits of local versus national distribution of rewards and penalties, see the section titled “Distribute rewards and penalties within local market areas” (p. 67).

Under our MA–VIP model, a market area’s parent organizations with better quality scores (i.e., more MA–VIP points) receive a net positive payment adjustment, or a reward, and those with worse quality scores receive a net negative payment adjustment, or a penalty. Figure 3-5 (p. 80) and Figure 3-6 (p. 81) summarize the quality scores (MA–VIP points) achieved and net payment adjustments, by peer group, for the 78 parent organizations in the model’s 61 markets (totaling 258 parent organization and market observations for each peer group).

Figure 3-5 (p. 80) shows the results for three markets’ fully dual-eligible enrollees (Peer Group 1). Market 1 had low average performance (ranked 54th for both peer groups among all markets), Market 3 had high average performance (ranked 2nd and 3rd for each peer group), and Market 2 had average performance, near the middle of all markets. Parent organizations (shown with circles) in each market are distributed according to the average points achieved, and the size of each circle is proportional to enrollment. In Market 1, two parent organizations received a reward and one parent organization received a penalty. The dotted line in each market shows the threshold for receiving a penalty or reward in that market. Because rewards are distributed within each market, the threshold varies by market.

The size of any reward or penalty depends on the distribution of points achieved and distribution of enrollment among parent organizations in the market area. In Market 1, the parent organization with the largest share of fully dual-eligible enrollees in the market achieved 2.2 points and received a penalty of 0.35 percent, offsetting rewards of 0.57 percent (percent not shown) for a parent organization with very small enrollment achieving 3.5 points, and of 1.48 percent for a parent organization with moderate enrollment achieving 4.7 points. Figure 3-6 (p. 81) shows results for all other enrollees (Peer Group 2) for the same three markets.

Overall, parent organizations’ other-enrollee peer group (Peer Group 2) performed better—that is, scored more points under the model. Ninety-seven percent of parent organizations achieved more points for Peer Group 2 than Peer Group 1, and the thresholds for receiving a reward or penalty were higher in every market for Peer Group 2.

For both peer groups, the range of points across markets varied from about 1 to 5 points (out of 10 points) and was not strongly correlated with the average performance in the market (i.e., markets with higher average performance

FIGURE 3-5

Illustrative MA-VIP: Points achieved and net payment adjustment for parent organizations in three markets, fully dual-eligible enrollees (Peer Group 1)

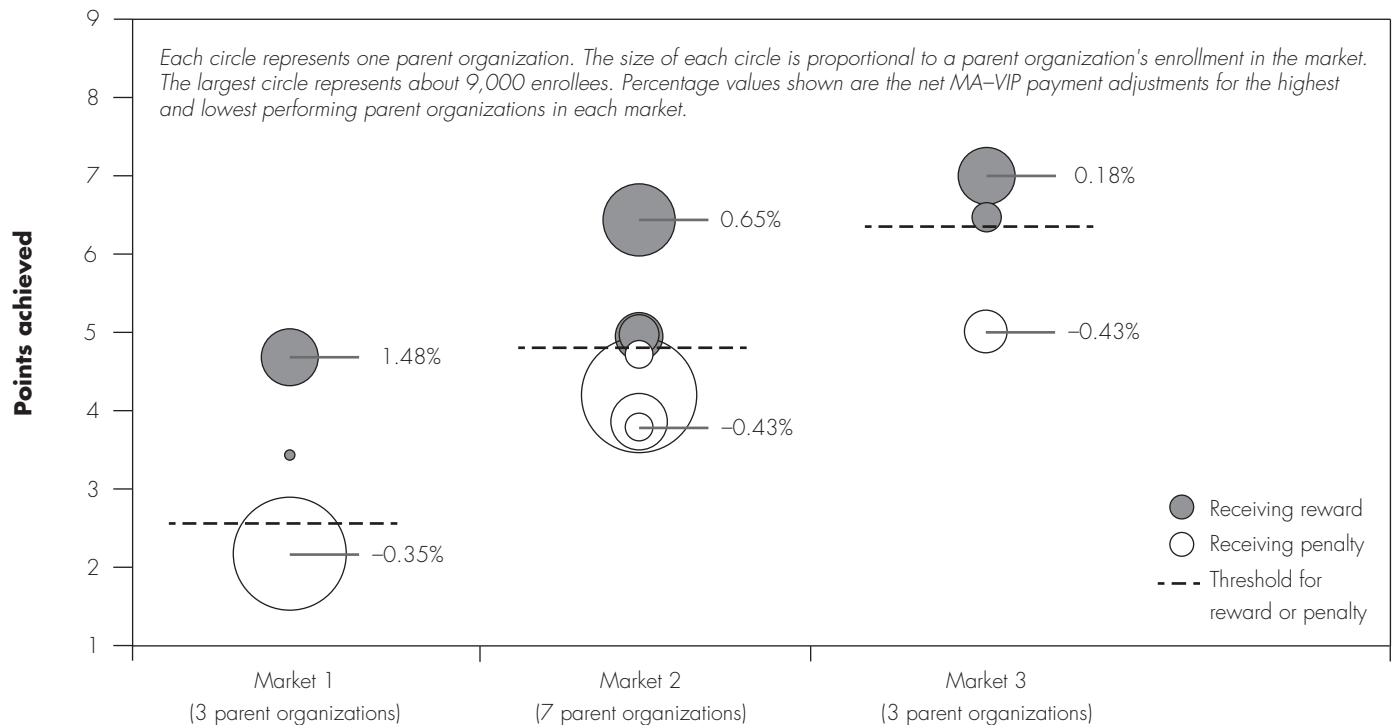

Note: MA-VIP (Medicare Advantage value incentive program). Each circle represents one parent organization, where the size of the circle is proportional to enrollment for that peer group. Parent organizations receiving a reward are shown in gray, and parent organizations receiving a penalty are shown in white. The line in each market shows the threshold for receiving a penalty or reward in that market. The net MA-VIP payment adjustment (percent) is shown for the highest and lowest performing parent organizations in each market.

Source: MedPAC analysis of MA quality and payment data, 2015–2017.

did not tend to have a wider or narrower range of points achieved). However, the range of points achieved was moderately correlated with the number of parent organizations in the market, meaning that markets with more parent organizations tended to have a slightly wider range of points achieved.

Our MA-VIP modeling uses 2 percent of total plan payments as the basis for each reward pool; however, payment adjustments of nearly -2 percent or 2 percent would require extremes in performance in the same market. In our modeling, Figure 3-8 (p. 84) shows that net payment adjustments varied from a penalty of 1.5 percent of payment to a reward of 1.5 percent of payment for the fully dual-eligible enrollee peer groups (Peer Group 1), and from a penalty of 1.5 percent of payment to 1.0

percent of payment reward for the all-other peer groups (Peer Group 2). Most parent organizations in a market area had net payment adjustments between -0.5 percent (penalty) and 0.5 percent (reward) for each peer group.

Figure 3-9 (p. 85) shows the distribution of net payment adjustments aggregated to the parent organization (combining net payment adjustments across peer groups and market areas). Parent-organization payment adjustments ranged from about -1.1 percent to about 1.0 percent, with 76 of the 78 parent organizations receiving a net payment adjustment roughly between -0.6 percent and 0.6 percent, and a little more than half of all parent organizations receiving a net payment adjustment between -0.2 percent and 0.2 percent.

FIGURE 3-6

Illustrative MA-VIP model: Points achieved and net payment adjustment for parent organizations in three example markets, all other enrollees (Peer Group 2)

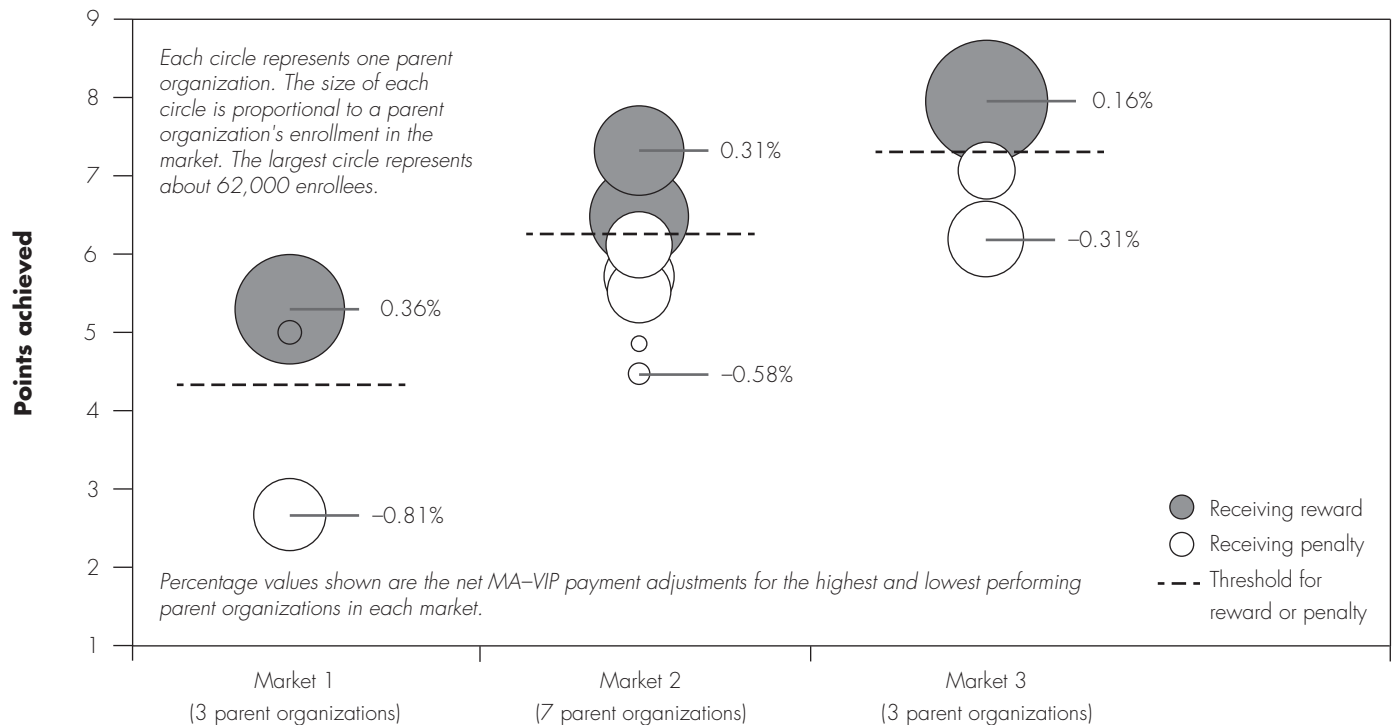

Note: MA-VIP (Medicare Advantage value incentive program). Each circle represents one parent organization, where the size of the circle is proportional to enrollment for that peer group. Parent organizations receiving a reward are shown in gray, and parent organizations receiving a penalty are shown in white. The line in each market shows the threshold for receiving a penalty or reward in that market. The net payment adjustment (percent) is shown for the highest and lowest performing parent organizations in each market.

Source: MedPAC analysis of MA quality and payment data, 2015–2017.

The black bars in Figure 3-9 (p. 85) represent 11 parent organizations participating in 5 or more markets (and therefore tending to have greater total enrollment). Collectively, these parent organizations accounted for 161 of the observations in our model (62 percent) and received a reward 42 percent of the time. Because they participated in more markets and received both rewards and penalties, these parent organizations received offsetting rewards and penalties. The share of markets in which they received a reward ranged from 23 percent to 80 percent, whereas 55 parent organizations received only rewards or only penalties (45 of these parent organizations participated in only one market).

Modifying the magnitude of rewards and penalties

Because small rewards and penalties may not provide an adequate incentive for plans to improve quality, policymakers may want to increase the magnitude of rewards and penalties. Two aspects of the MA-VIP model could be modified to increase rewards and penalties: (1) the performance-to-points scale could be based on a truncated set of national results so that points achieved are disbursed more widely between 0 and 10 points, or (2) the size of the reward pools could be increased above 2 percent (possibly after a phase-in period) and based on a greater share of total payments. Either approach would

Illustration of national distribution of Medicare Advantage value incentive program rewards and penalties

An alternative approach to distributing rewards and penalties within each market would use a national distribution, whereby each peer group's reward pool would be distributed according to national performance results for all parent organizations in each market.²¹

Figure 3-7 shows the results of a national distribution for the other-enrollees group (Peer Group 2). The threshold for receiving a national reward or penalty

in every market was about 5.6 points. Applying the national threshold causes all parent organizations in Market 1 to receive a penalty and all parent organizations in Market 3 to receive a reward. Under this approach for the 61 markets in our model, all parent organizations in 9 markets would have received a national penalty and all parent organizations in 8 markets would have received a national reward for Peer Group 2 (about 28 percent of markets were reward only or penalty only). About 79 percent of national rewards

(continued next page)

FIGURE 3-7

Illustration of national MA-VIP distribution of rewards and penalties: Average points achieved and net payment adjustment for parent organizations in three example markets, all other enrollees (Peer Group 2)

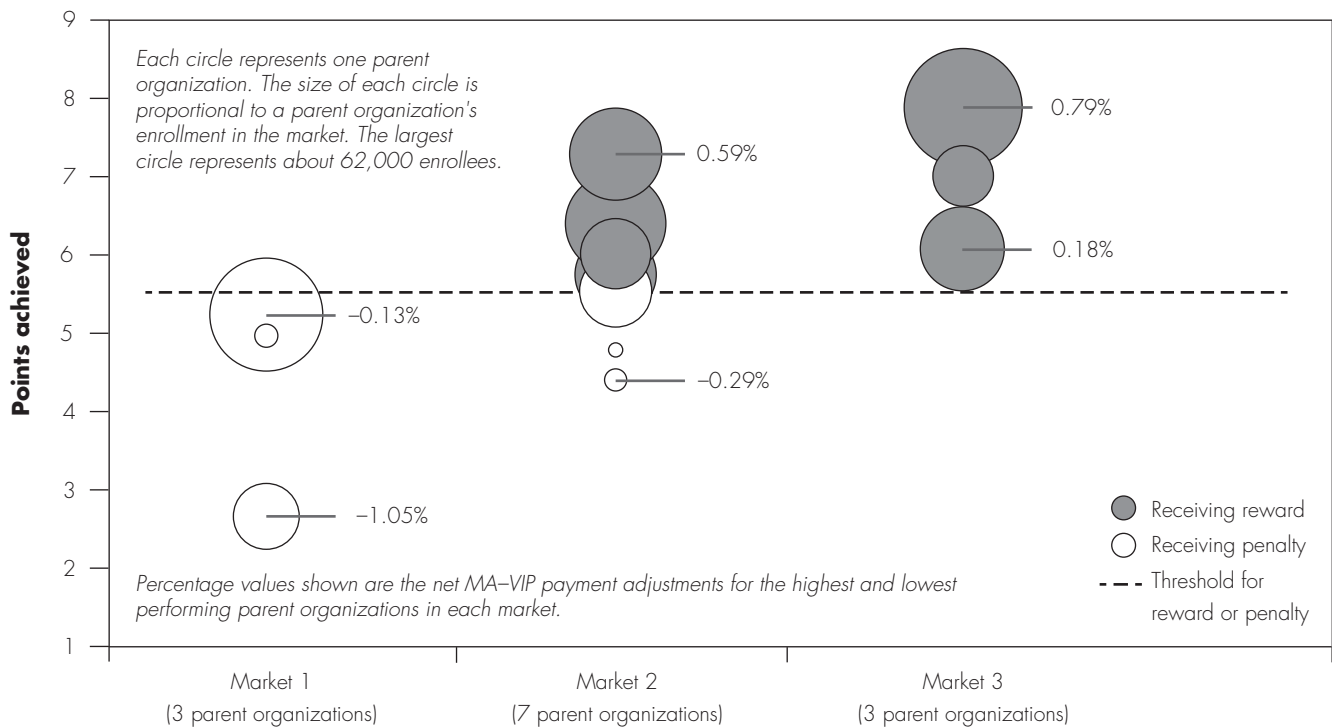

Note: MA-VIP (Medicare Advantage value incentive program). Each circle represents one parent organization, where the size of the circle is proportional to enrollment for that peer group. Parent organizations receiving a reward are shown in gray and parent organizations receiving a penalty are shown in white. The line in each market shows the threshold for receiving a penalty or reward in that market. The net MA-VIP payment adjustment (percent) is shown for the highest and lowest performing parent organizations in each market.

Source: MedPAC analysis of MA quality and payment data, 2015-2017.

Illustration of national distribution of Medicare Advantage value incentive program rewards and penalties (cont.)

for Peer Group 2 were distributed in the top half of markets (ranked by average market performance). These rewards were generated by penalties assessed mostly in the bottom half of markets, resulting in a broad transfer of rewards from lower performing markets to higher performing markets.

For fully dual-eligible enrollees (data not shown), the threshold for receiving a national reward or penalty was about 4.8 points nationally, and there were nine penalty-only markets and nine reward-only markets (about 30 percent of all markets). About 86 percent of all national rewards were distributed in the top half of markets (based on average market performance). ■

have the effect of stretching the distribution of net payment adjustments shown in Figure 3-8 (p. 84) and increasing the magnitude of rewards and penalties.²²

Comparison of MA-VIP model to existing MA QBP

Compared with the current QBP, our modeling demonstrates that the MA-VIP design would:

- address concerns about whether plans with large shares of high-needs populations are treated fairly,
- deal with geographic differences in the bonus status of population subgroups,
- eliminate the QBP's cliff effect, and
- not give an undue advantage to larger companies with more resources to manage the star system and companies that have benefited from contract consolidation.

Special populations

Under the QBP, with 83 percent of enrollees currently in bonus-level plans, nearly all MA enrollees are in plans deemed high quality. However, there are differences by population categories and by plan categories with respect to the rewarding of bonus payments under the QBP. Generally, plans with high shares of low-income enrollees, plans with high shares of enrollees under the age of 65 (entitled to Medicare on the basis of disability), and relatively smaller plans are less likely to have a bonus-level star rating. For example, in 2017, while about 75 percent of all MA enrollees were in bonus-level plans, the share among the fully dual-eligible population was

54 percent. For enrollees in employer group waiver plans (EGWPs, which provide MA coverage to employer-sponsored or union-sponsored retirees), the share in bonus plans was 92 percent in 2017. (EGWP status can be considered a proxy for higher income status, better health, and better access to health care.)

CMS employs a peer-grouping system in awarding star ratings so that plans with relatively higher shares of low-income beneficiaries and plans with higher shares of disabled beneficiaries have an adjustment to their star ratings—a feature intended to increase their likelihood of being in bonus status. However, the CMS peer grouping appears to only marginally change the bonus status of such plans. Our proposed MA-VIP instead uses a stratification approach to compare like populations. Under this model, an organization's performance for its fully dual-eligible population is compared with the performance of other organizations in the same market area for their fully dual-eligible population.

The MA-VIP stratification into peer groups and market-level comparison approach helps to level the playing field for plans serving fully dual-eligible beneficiaries (Figure 3-10, p. 86). Although in the QBP there are large differences in the share of fully dual-eligible beneficiaries versus other beneficiaries in bonus-level plans (54 percent vs. 82 percent in 2017), that difference is substantially narrower under the MA-VIP with respect to the share of enrollees in the MA-VIP peer group receiving positive financial results (53 percent vs. 57 percent).

The stratification used for the MA-VIP modeling separates only fully dual-eligible beneficiaries and all others. The Commission's past work has recognized

**FIGURE
3-8**

Illustrative MA-VIP: Most peer groups of parent organizations in a market area receive small payment adjustments (rewards or penalties)

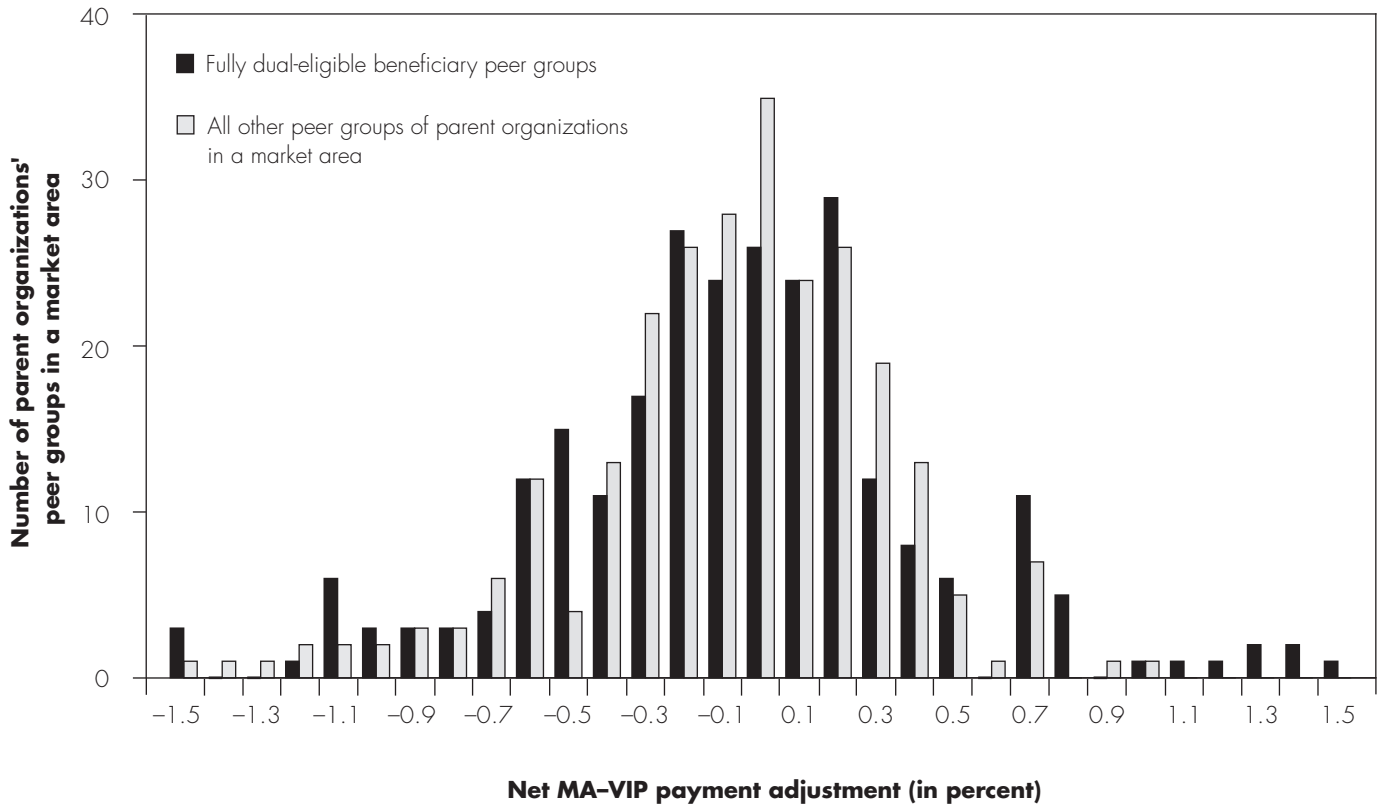

Note: MA-VIP (Medicare Advantage value incentive program). The figure represents the distribution of net MA-VIP percent payment adjustments that peer groups receive after accounting for the 2 percent payment withhold used to create the pool of dollars to be redistributed. Changing the withhold percentage would expand or contract the distribution in line with the magnitude of the change in the percentage payment amount.

Source: MedPAC analysis of MA quality and payment data, 2015–2017.

systematic differences in quality results for the EGWP and under-65 populations, and CMS makes an adjustment to star ratings for contracts with high shares of enrollees originally entitled to Medicare on the basis of disability. Figure 3-10 (p. 86) shows that in the MA-VIP model, the EGWP population continues to fare better, and the under-65 population group fares slightly less well than the fully dual-eligible beneficiary group (51 percent for the under-65 population and 62 percent for EGWP enrollees, compared with 53 percent for the fully dual-eligible population). Our modeling is meant to be an illustrative prototype of how the MA-VIP could apply peer grouping, but when implementing the program,

it might be appropriate to stratify the EGWP and under-65 populations in addition to the fully dual-eligible population.

Eliminating the cliff and leveling size and sponsorship differences

With a continuous performance-to-points scale, and in part because of determinations made at the local market level, the MA-VIP design addresses another design flaw of the QBP system, in which plans lose bonus status if they fall short of a moving target that qualifies plans for bonuses (the “cliff” in the QBP). Only contracts with an average star rating of 3.75 (rounded to 4) or better on the

FIGURE 3-9

Illustrative MA-VIP: Net payment adjustment by parent organization

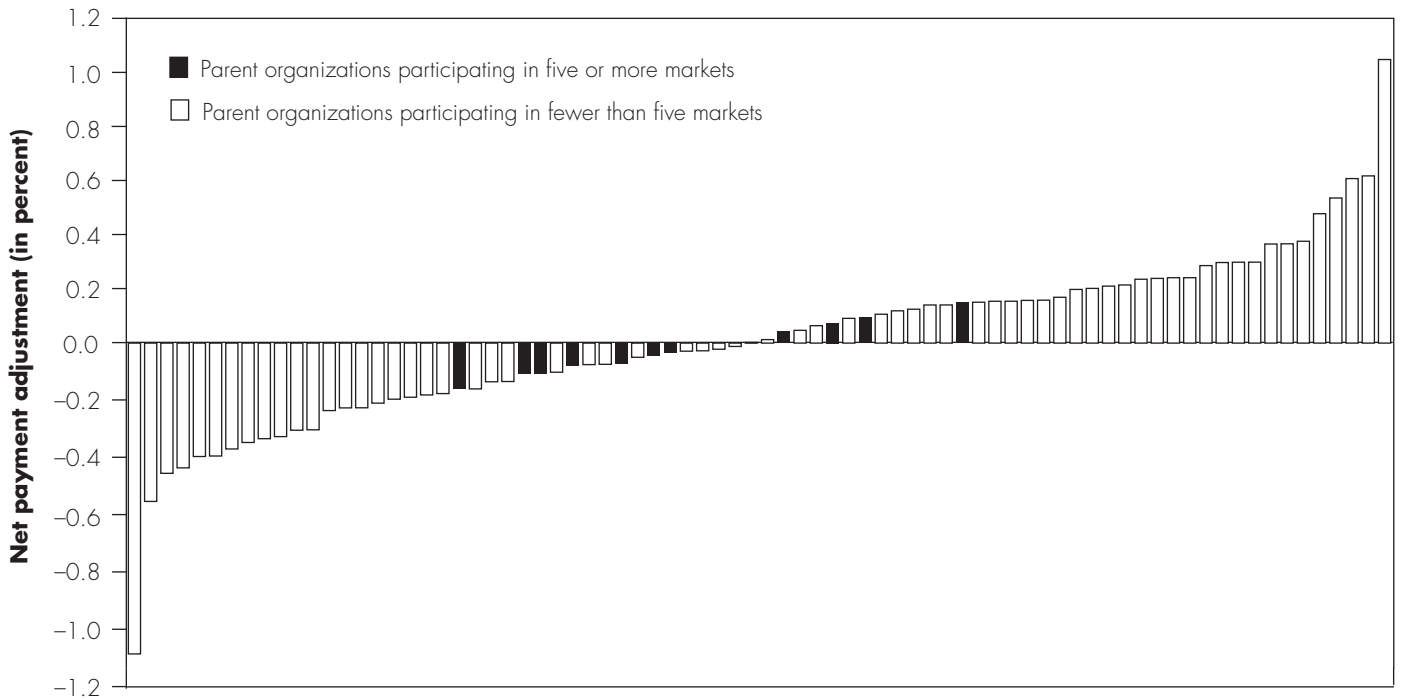

Parent organizations ranked by net payment adjustment

Note: MA-VIP (Medicare Advantage value incentive program). The figure represents the distribution of net payment adjustments received by parent organizations in the MA-VIP model. There are 78 distinct parent organizations in the illustrative MA-VIP model.

Source: MedPAC analysis of MA quality and payment data, 2015–2017.

5-star scale receive bonuses. In addition, in the QBP there are only small differences in the treatment of MA plans at or above 4 stars that could otherwise be distinguished because there are 4-star, 4.5-star, and 5-star contracts.

Among the plans included in our MA-VIP modeling, 20 parent organizations received no QBP bonus dollars in any of their markets. In our MA-VIP modeling, 8 of the 20 had positive results, ranging from a reward of 0.16 percent to 0.62 percent. These organizations are primarily regional plans (that is, plans operating in single markets or a small number of markets rather than organizations that have plans across the country). Six of the organizations operate in only one state, one operates in two states, and one has enrollment in five states.

The eight organizations benefiting under the MA-VIP compared with their QBP status had relatively small

enrollment, illustrating that, under the QBP, differences exist between large contracts and small contracts. In the 2020 star ratings, 92 percent of enrollees in contracts with over 100,000 enrollees were in bonus-level contracts. For contracts with enrollment at or below 100,000, only 64 percent of enrollees were in contracts with bonus status. The larger contracts are often multistate contracts, and many are in bonus status as a result of contract consolidations. The three largest companies in MA enrollment have from 80 percent to 90 percent of their enrollment in bonus-level plans under the QBP. In the MA-VIP modeling, however, the performance of these organizations across markets varies significantly, and the companies have penalties in some markets and rewards in others.

A final point is that all the measures used in our model—other than the ambulatory care-sensitive hospitalization

**FIGURE
3-10**

For fully dual-eligible enrollees, plans have similar shares of enrollees in bonus status or positive illustrative MA-VIP results

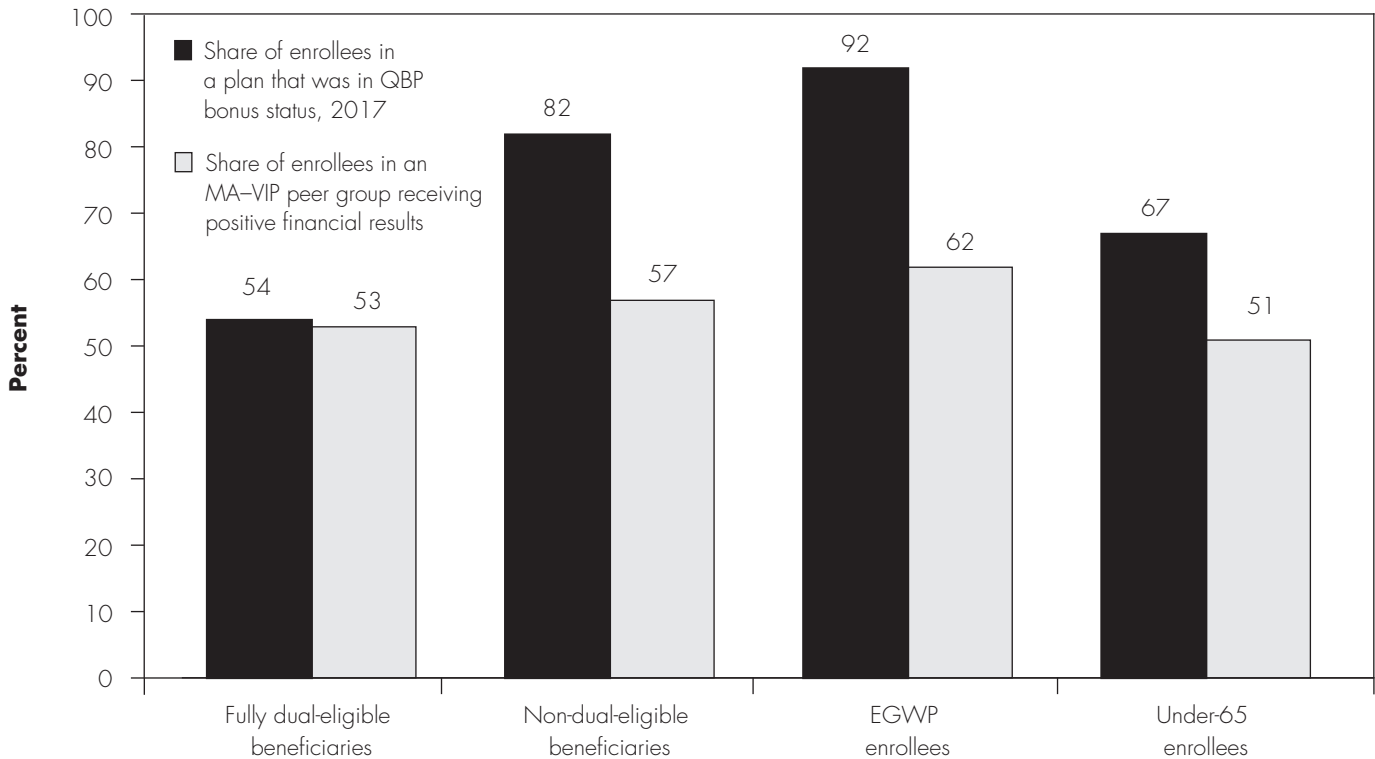

Note: MA-VIP (Medicare Advantage value incentive program), QBP (quality bonus program), EGWP (employer group waiver plan). "Positive financial result" is an MA-VIP payment adjustment that exceeds the 2 percent of plan payments used to create the pool of dollars to be redistributed.

Source: MedPAC analysis of MA quality, enrollment, and payment data, 2015–2017.

measure—are used in the current star rating system to develop an average plan rating. Other measures include administrative measures (such as the timeliness of appeals processing), and some contracts have achieved their QBP bonus status on the strength of their good performance on measures other than outcome measures. Larger plans perform well on the administrative measures. If QBP stars were assigned solely based on the outcome measures used in our model, for 2020, only about one-third of MA enrollees would be in bonus-level plans, compared with 83 percent of enrollees currently in such plans. Rather than \$6 billion in added program payments, the added payments would be more in the range of \$2.3 billion.

Replacing the Medicare Advantage quality bonus program with a new value incentive program

Because of the many flaws of the QBP and the star system, the Commission asserts that Medicare lacks reliable information on which to evaluate quality within the MA sector. Fixing MA's quality measurement and quality incentive program is of the highest importance given that more than one-third of beneficiaries receive their care through MA plans and Medicare program expenditures for MA now total \$274 billion annually. The Commission has discussed moving Medicare into more value-based

payment models in which an entity is accountable for both the cost and quality of care provided to Medicare beneficiaries on a population basis. MA is such a model, but the current state of quality reporting and measurement in MA does not provide a basis for properly evaluating the effectiveness of this model, nor does the current system provide accurate information to beneficiaries. The flaws of MA quality measurement must be addressed so that Medicare can have confidence that high quality is being appropriately rewarded based on accurate information about plan performance.

Our exercise in calculating an illustrative MA–VIP prototype has demonstrated that it is feasible for the Medicare program to implement a system that addresses the QBP’s flaws. The model distributes both rewards and penalties to plans within market areas, based on plan performance on quality measures tied to clinical outcomes and patient experience. Under this model, most plans have the potential to receive higher rewards if their enrollee populations include large shares of enrollees with social risk factors. As compared with the QBP, the modeling results also show reduced disparity in plans’ financial performance with respect to fully dual-eligible enrollees compared with the financial performance for other enrollees.

The current practice of collecting data and measuring quality at the MA contract level limited the availability of data to use in our model; thus, the model is not meant to provide an exact formula for a QBP replacement. To make a program change, CMS should use the formal rule-making process to select measures, set performance-to-points targets, and define the social risk factors that are accounted for in peer groups.

RECOMMENDATION 3

The Congress should replace the current Medicare Advantage (MA) quality bonus program with a new MA value incentive program that:

- **scores a small set of population-based measures;**
- **evaluates quality at the local market level;**
- **uses a peer-grouping mechanism to account for differences in enrollees’ social risk factors;**
- **establishes a system for distributing rewards with no “cliff” effects; and**
- **distributes plan-financed rewards and penalties at a local market level.**

MA plans will be scored on their performance on quality and value measures, such as readmissions, patient

experience, patient-reported outcomes, and clinical care measures tied to outcomes. MA plan quality will be calculated at a local market level—for example, a parent organization within a market area instead of at the contract level. To account for differences in the social risk factors of plan populations, the MA–VIP will stratify results by defined peer groups, such as eligibility for Medicaid. Comparing groups with similar population characteristics accounts for social risk factors. We expect that as more data and research about the effects of patient-level social risk factors on quality performance become available, the approaches to assigning beneficiaries to a peer group will evolve.

The MA–VIP will reward or penalize a plan based on the plan’s performance relative to other plans in the market using a continuous, prospectively set performance-to-points scale for each measure. The MA–VIP redistributes a pool of dollars (made up of a percentage of plan payments within a market area) as rewards and penalties based on a plan’s performance compared with the market area’s other plans.

RATIONALE 3

The QBP is flawed and does not provide a reliable basis for evaluating MA quality in meaningful ways; plans have also received unwarranted bonus payments under the QBP system. Compared with the QBP, the MA–VIP will provide the program and Medicare beneficiaries with more accurate information on MA quality, and it is designed to produce a fairer distribution of incentive payments across markets and across the different population groups enrolled in MA.

The QBP currently costs the Medicare program \$6 billion a year in added program payments. Making the MA–VIP a plan-financed system that does not involve additional dollars will put the MA program on a par with nearly all FFS quality incentive programs, which are budget neutral or produce program savings. The Commission’s recommendation to replace the QBP with the MA–VIP produces program savings through reduced MA payments. The recommendation reflects the Commission’s interest in achieving equity in MA quality incentives and greater accuracy in determining plan eligibility for incentive payments. The recommendation is not intended as a strategy for establishing the appropriate level of overall payment to MA plans. In addition to developing an equitable system for quality-based payments, an assessment of overall payment adequacy for MA plans

should encompass all factors affecting MA plan payment, including policies for setting MA benchmarks and rebate levels, risk adjustment, and coding intensity—issues that the Commission has addressed, and will continue to address, in each year’s March report to the Congress.

IMPLICATIONS 3

Spending

- This recommendation is expected to reduce program spending relative to current policy by more than \$2 billion over one year and by more than \$10 billion over five years.

Beneficiary and provider

- We do not expect this recommendation to have adverse effects on beneficiaries’ access to plans or on plan participation in MA.
- It is possible that beneficiaries will see a reduction in extra benefits because plans will have lower payments; how much of a change there would be in extra benefits

depends on how plans respond to lower benchmarks and how they fare financially in the MA–VIP system. Bids could go up, but plans may also choose to reduce profits or otherwise lower their cost of providing the Medicare benefit—that is, they would become more efficient.

- To the extent that more money flows to plans serving high-needs populations, enrollees in those plans could have additional extra benefits. From the plan point of view, in addition to possible payment increases, the plans serving high-needs populations would be on a more even footing in competing with other plans in their area because of the stratification approach in determining rewards and penalties.
- With the MA–VIP, beneficiaries will have better information on the quality of plans in their area. Plans, however, will have higher administrative costs because of the use of the local area as the reporting unit. For example, more surveys will have to be administered. ■

Endnotes

- 1 Note also that, with respect to expected total expenditures for the QBP, the Congressional Budget Office estimate of a 10-year cost of \$94 billion if the QBP continues is an estimate that takes into account the Bipartisan Budget Act of 2018 provision requiring a weighted average of star ratings to determine the star rating of the surviving contract after a consolidation; that is, it takes into account the limited opportunities for future consolidation (Congressional Budget Office 2018).
- 2 HEDIS® is a registered trademark of the National Committee for Quality Assurance.
- 3 Almost all of the measure concepts in the illustrative measure set are part of the current MA star rating program and are included in the current Medicare ACO quality measure set.
- 4 Beginning with the 2021 star ratings, any changes to the measure set and scoring methodology will go through a formal rule-making process with notice and public comment. Before the 2021 star ratings, CMS announced and sought feedback on changes to the star ratings through the Part C and Part D call letter.
- 5 The relevant HEDIS measures currently available for plans to calculate using electronic clinical data systems include breast cancer screening and colorectal cancer screening. Plans can currently choose to report measure results through the traditional administrative data and medical record review or by incorporating data from electronic clinical data systems.
- 6 CAHPS® is a registered trademark of the Agency for Healthcare Research and Quality.
- 7 The HOS measures in the star system, and consequently in our modeling results, apply only to aged enrollees, even though enrollees under the age of 65 are also surveyed. CMS is considering using HOS results for the entire population of Medicare beneficiaries and has proposed expanding the minimum number of necessary responses from 30 to 100.
- 8 The CMS website includes files that identify the parent organization of each MA contract (<https://www.cms.gov/Research-Statistics-Data-and-Systems/Statistics-Trends-and-Reports/MCRAAdvPartDENrolData/MA-Plan-Directory>). CMS defines a parent organization as “the legal entity that owns a controlling interest in a contracting organization...[and is] the ‘ultimate’ parent, or the top entity in a hierarchy (which may include other parent organizations) of subsidiary organizations which is not itself a subsidiary of any corporation. A legal entity may be its own parent organization if it is not a subsidiary of any other organization” (Centers for Medicare & Medicaid Services 2012).
- 9 In the hospital value incentive program, the term *peer group* means groups of hospitals. In the MA–VIP, *peer group* refers to groups of enrollees, sorted by various factors, including but not limited to social risk factors.
- 10 CMS also applies postmeasurement adjustments to overall star ratings, including a reward factor (rewarding a contract showing good performance across multiple measures), an improvement score for Part C and Part D improved performance that each has a weight of 5, and a “categorical adjustment index” that raises or lowers a contract’s overall star rating based on a contract’s share of low-income enrollees and the share of beneficiaries originally entitled to Medicare on the basis of disability (rather than age).
- 11 In prior years, outlier results for some measures distorted the clusters and inappropriately skewed the cut points identified by the clustering algorithm. For 2020, CMS modified the approach to put in place “guardrails” whereby, from one year to the next, the increase or decrease in cut points is limited to a 5 percent change (42 CFR §423.186(i)). CMS is also proposing to further reduce the effect of outliers (Centers for Medicare & Medicaid Services 2020).
- 12 A performance-to-points scale based on multiple years might simplify administration of the MA–VIP, but there is a tension between multiyear targets and the MA–VIP approach to financing. Revising targets each year would allow yearly calibration between (1) dollars expended as rewards or reduced payments through penalties and (2) the dollar amount that would most closely approximate budget neutrality in each year.
- 13 In the QBP, in addition to the incentive to achieve a 4-star rating and obtain bonuses, there are incentives to achieve an overall rating above 4 stars because contracts with a rating of 4.5 or 5 stars receive a higher level of rebate dollars, and 5-star plans can enroll beneficiaries outside of the annual election period. Policymakers will have to determine how these incentive provisions are treated in the MA–VIP system.
- 14 Plans apply administrative costs and profits to “load” the rebate dollars. The load averages 10 percent for extra benefits. When we report that in 2020 rebates are valued at \$122 per month, the “net” value to beneficiaries is about \$110 after accounting for the load. The \$27 figure includes the load, meaning that the net maximum change for beneficiaries would be \$24.
- 15 Comparison with FFS Medicare requires sufficient survey data within each market area. The CAHPS and the HOS are not fielded among FFS beneficiaries in each market, but

given sufficient funding, necessary survey data could be collected and available for comparison within a few years. MA encounter data have been found incomplete for some measures, and it is not clear when encounter data will be complete and available for all MA–VIP measures.

- 16 Hospitals are required to submit “no-pay” claims directly to CMS for all MA enrollees. Generally, these claims are a copy of claims hospitals submit to plans for payment. CMS uses no-pay claims in calculating disproportionate share hospital payments, medical education payments, and certain quality and utilization measures.
- 17 Using encounter data from 2015 to 2017, we calculated observed rates of ACS emergency department visits for the MA–VIP reporting units (i.e., parent organization within a market area) and found a distribution of visits suggesting that the outpatient encounter data are incomplete (including a number of reporting units with zero observed ED visits).
- 18 Metropolitan counties are grouped into a MedPAC market area if they are located in the same state and the same metropolitan statistical area. Nonmetropolitan counties are grouped into a MedPAC market area if they are located in the same state and the same health service area as defined by the National Center for Health Statistics. States can have multiple nonmetropolitan MedPAC market areas.
- 19 We used only the 600-enrollee criterion for this analysis because it is more limiting than the minimum sample size for ACS hospitalizations (150 enrollees) and about equally limiting as the readmission minimum sample size (150 admissions) using a rough average admission rate of 250 per 1,000 enrollees ($600 \text{ enrollees} \times 250 / 1,000 \text{ admission rate} = 150 \text{ admissions}$).
- 20 The market areas that did not have higher payment multipliers for the fully dual-eligible peer group had payment multipliers that were equal for both peer groups, or the all-others peer group payment multiplier was only a small percentage higher.
- 21 More specifically, to distribute the national share of the reward pool, the points achieved for each parent organization and each market for fully dual-eligible enrollees (Peer Group 1) would be pooled and a national pool of dollars would be distributed in one national market. The process would be repeated for the other-enrollees group (Peer Group 2).
- 22 In the MA–VIP design portion of this chapter, the section titled “Distribute plan-financed rewards and penalties at a local market level” (p. 62), we do not specify the share of plan payments that should be used to finance MA–VIP rewards. Policymakers should decide the appropriate level of plan payments to finance MA–VIP rewards.

References

- Agency for Healthcare Quality and Research, Department of Health and Human Services. 2020. Talking quality: Reporting to consumers on health care quality. <https://www.ahrq.gov/talkingquality/index.html>.
- Aligning Forces for Quality. 2009. *How to display comparative information that people can understand and use*. Research conducted on behalf of the Robert Wood Johnson Foundation. Washington, DC: Aligning Forces for Quality. <http://forces4quality.org/how-display-comparative-information-people-can-understand-and-use.html>.
- Centers for Medicare & Medicaid Services, Department of Health and Human Services. 2020. Medicare and Medicaid programs; Contract year 2021 and 2022 policy and technical changes to the Medicare Advantage program, Medicare Prescription Drug benefit program, Medicaid program, Medicare Cost Plan program, and Programs of All-Inclusive Care for the Elderly. Noticed of proposed rulemaking. *Federal Register* 85, no. 32 (February 18): 9002–9260.
- Centers for Medicare & Medicaid Services, Department of Health and Human Services. 2012. Memo to all current and prospective Medicare Advantage, prescription drug plan, cost and PACE organizations regarding verification of parent organization and legal entity name for 2013, March 2.
- Congressional Budget Office. 2018. *Options for reducing the deficit: 2019 to 2028*. Washington, DC: CBO.
- Government Accountability Office. 2012. *Medicare Advantage: Quality bonus payment demonstration undermined by high estimated costs and design shortcomings*. Washington, DC: GAO.
- Marshall, M. N., P. G. Shekelle, H. T. Davies, et al. 2003. Public reporting on quality in the United States and the United Kingdom. *Health Affairs* 22, no. 3 (May–June): 134–148.
- Medicare Payment Advisory Commission. 2019a. *A data book: Health care spending and the Medicare program*. Washington, DC: MedPAC.
- Medicare Payment Advisory Commission. 2019b. *Report to the Congress: Medicare and the health care delivery system*. Washington, DC: MedPAC.
- Medicare Payment Advisory Commission. 2019c. *Report to the Congress: Medicare payment policy*. Washington, DC: MedPAC.
- Medicare Payment Advisory Commission. 2018a. *Report to the Congress: Medicare and the health care delivery system*. Washington, DC: MedPAC.
- Medicare Payment Advisory Commission. 2018b. *Report to the Congress: Medicare payment policy*. Washington, DC: MedPAC.
- Medicare Payment Advisory Commission. 2017. *Report to the Congress: Medicare payment policy*. Washington, DC: MedPAC.
- Medicare Payment Advisory Commission. 2016. *Report to the Congress: Medicare and the health care delivery system*. Washington, DC: MedPAC.
- Medicare Payment Advisory Commission. 2010a. *Report to the Congress: Aligning incentives in Medicare*. Washington, DC: MedPAC.
- Medicare Payment Advisory Commission. 2010b. *Report to the Congress: Medicare payment policy*. Washington, DC: MedPAC.
- Rose, A. J., E. Bayliss, L. Baseman, et al. 2019. Feasibility of distinguishing performance among provider groups using patient-reported outcome measures in older adults with multiple chronic conditions. *Medical Care* 57, no. 3 (March): 180–186.
- Safran, D. G. 2019. Feasibility and value of patient-reported outcome measures for value-based payment. *Medical Care* 57, no. 3 (March): 177–179.
- Wholey, D. R., J. B. Christianson, M. Finch, et al. 2003. Evaluating health plan quality 1: A conceptual model. *American Journal of Managed Care* 9 spec. no. 2 (June): SP53–64.

CHAPTER 4

**Mandated report: Impact of
changes in the 21st Century
Cures Act to risk adjustment for
Medicare Advantage enrollees**

Mandated report: Impact of changes in the 21st Century Cures Act to risk adjustment for Medicare Advantage enrollees

Chapter summary

The Medicare program pays managed care plans that participate in the Medicare Advantage (MA) program a monthly capitated amount to provide Medicare-covered services to its Medicare enrollees. Payment for each enrollee has two parts: a base rate and a risk score. The base rates vary by county, with the base rate for a given county reflecting the payment for an MA enrollee in that county with the health status of the national average beneficiary in fee-for-service (FFS) Medicare. The risk score indicates how costly the enrollee would be expected to be in FFS Medicare, relative to the national average FFS beneficiary.

The 21st Century Cures Act of 2016 directs the Secretary to make several changes to the CMS hierarchical condition category (CMS-HCC) model, which CMS uses to calculate enrollees' risk scores. The changes required by the 21st Century Cures Act include the following:

- Add indicators and adjustments for the total number of diseases or conditions for each enrollee.
- For beneficiaries who receive full Medicaid benefits, provide payment adjustments that are separate and different from payment adjustments for beneficiaries who receive partial Medicaid benefits. Until 2017, the CMS-HCC model had provided the same payment adjustment for these two beneficiary groups.

In this chapter

- Background on Medicare Advantage payments and risk adjustment
- Changes required by the 21st Century Cures Act
- Impacts of changes to CMS's risk adjustment model for Medicare Advantage
- Summary

- Evaluate the effects of including additional diagnosis codes for mental health disorders, substance abuse disorders, and chronic kidney disease.

In addition, the 21st Century Cures Act provides that the Secretary “may use at least two years of diagnosis data” to determine risk scores but does not appear to *require* the Secretary to do so.

CMS has implemented the mandated changes incrementally, applying different adjustments for full-benefit and partial-benefit dually eligible beneficiaries in 2017; adjustments for mental health disorders, substance abuse disorders, and chronic kidney disease in 2019; and adjustments for the number of conditions for each beneficiary in 2020. CMS has not implemented the use of two years of diagnosis data to determine risk scores.

The 21st Century Cures Act directs the Commission to evaluate the impact of these changes to the CMS–HCC model. To carry out this mandate, we evaluated five versions of the CMS–HCC model: the model that CMS used before implementing any of the changes mandated by the 21st Century Cures Act, the three models that CMS has implemented in response to the Act’s requirements, and a version that we developed that uses two years of diagnosis data to determine risk scores.

We evaluated how well each of the five versions of the CMS–HCC model predicts costs for various Medicare FFS beneficiary populations grouped by health characteristics, including type of medical conditions, number of medical conditions, and level of Medicare program spending. For each group, we calculated what each version of the CMS–HCC model predicts in costs for all of the group’s beneficiaries over one year (aggregate predicted costs). For each group, we also calculated how much Medicare actually spent on those FFS beneficiaries over one year (aggregate actual costs).

For each group, we determined a predictive ratio (PR), which is the ratio of aggregate predicted costs to aggregate actual costs. The desired result for a given group is a PR of 1.0, which would indicate that the model predicts costs for the group that are equal to the actual costs for the group. A PR less than 1.0 indicates that predicted costs for the group are less than actual costs, and the model will produce underpayments for that group. A PR greater than 1.0 indicates that predicted costs for the group are greater than actual costs, and the model will produce overpayments for that group.

In general, we found that:

- Each model produces accurate payment adjustments for groups that have characteristics defined by variables that are included in the model.
- Making distinctly different adjustments for full-benefit dual-eligible beneficiaries and partial-benefit dual-eligible beneficiaries eliminates systematic underpayments for the full-benefit dual-eligible beneficiaries and systematic overpayments for the partial-benefit dual-eligible beneficiaries that had occurred in previous models that did not distinguish between these two populations.
- Adding variables to the CMS–HCC model for mental health disorders, substance abuse disorders, and chronic kidney disease improves how accurately the model adjusts payments for beneficiaries who have those conditions. However, we caution that adding variables to the CMS–HCC model can provide additional opportunities for MA plans to increase revenue by coding more medical conditions. Such increases in coding may be especially likely when the additional variables represent conditions that are diagnosed using relatively discretionary standards.
- Adding indicators for the number of medical conditions for each beneficiary improves the model’s accuracy in adjusting payments for beneficiaries who have no conditions indicated in the model and those who have many conditions.
- All of the models produce underpayments for beneficiaries with very high levels of Medicare spending and overpayments for those with very low levels of Medicare spending. Adding indicators for the number of medical conditions for each beneficiary *slightly* improves the model’s accuracy in adjusting payments for both beneficiary groups, but underpayments and overpayments remain. These payment inaccuracies have been a persistent issue for MA risk adjustment.

We also found that using two years of diagnosis data to determine beneficiaries’ conditions produces payment adjustments that are about as accurate as using one year of diagnosis data, though it produces larger underpayments for those with high levels of Medicare spending than using one year of diagnosis data. Nevertheless, in our view, the use of two years of diagnosis data would be beneficial for MA risk adjustment because it would decrease the extent of coding differences that persist between the MA and FFS sectors of the Medicare program. Using two years of diagnosis data allows the model to capture more medical conditions among the FFS population, so that the profile of conditions among the FFS population more

closely matches the profile of conditions that would have been recorded for those beneficiaries had they been enrolled in MA. The result would be reduced payment errors that occur because of coding differences between MA and FFS.

We commend the progress that CMS has made in implementing the changes to the CMS–HCC model mandated by the 21st Century Cures Act. We encourage CMS to continue its work on this issue to complete the requirements in the 21st Century Cures Act by the mandated date of January 1, 2022. ■

Benefits of using prospective risk adjustment in Medicare Advantage

Two general arguments have been made for using a prospective risk adjustment model rather than a concurrent model in Medicare Advantage (MA):

- Relative to a concurrent model, a prospective model gives health plans greater incentive to manage their enrollees' care to prevent their enrollees from developing costly new conditions. Use of a concurrent model would move the MA program away from its intended purpose—managing the medical conditions of its enrollees—and closer to a cost-based model because plans would be paid as their enrollees' conditions occur.
- Plans face less uncertainty about their revenue streams under a prospective model. Under concurrent models, payments are based on conditions diagnosed in the prediction year. But it takes time for data on those diagnoses to be processed so that payments can be adjusted. Plans' revenue may then require adjustments after the prediction year ends. For example, if an MA enrollee had a condition diagnosed in December 2019, CMS may not be able to make an adjustment to the plan's payment until 2020. Under a prospective model, conditions from the base year are used to adjust payments in the prediction year, so the likelihood that payment adjustments are needed after the prediction year is smaller.¹ ■

Background on Medicare Advantage payments and risk adjustment

Medicare pays managed care plans that participate in the Medicare Advantage (MA) program a monthly capitated amount for each Medicare enrollee to provide Medicare-covered services. Each capitated payment has two general parts: a base rate, which reflects the payment for an MA enrollee with the health status of the national average beneficiary in fee-for-service (FFS) Medicare, and a risk score, which indicates how costly the enrollee is expected to be relative to the national average FFS beneficiary. The purpose of the risk scores is to adjust MA payments so that they accurately reflect how much an MA enrollee is expected to cost relative to the national average.

Over the years, CMS has used a variety of methods for determining MA enrollees' risk scores. Currently, CMS uses the CMS hierarchical condition category (CMS-HCC) risk adjustment model, which uses enrollees' demographic characteristics and medical conditions (such as diabetes and stroke) to predict their costliness. The demographic variables include age, sex, Medicaid status, institutional status, eligibility based on disability, and eligibility based on age but originally eligible because of disability.

CMS draws data for demographic variables from the year in which beneficiaries' costs are to be predicted (the prediction year). CMS bases assigned conditions on one year of diagnoses recorded on physician, hospital outpatient, and hospital inpatient claims from the year before the prediction year (base year). CMS groups the diagnoses into broader disease categories called hierarchical condition categories (HCCs). In the CMS-HCC model, some conditions have more than one HCC, which differ by severity of the condition. Examples include diabetes and cancer. The "hierarchical" part of *HCC* means that if a beneficiary has diagnoses that map into more than one HCC for a specific condition, only the HCC that has the largest effect on the beneficiary's risk score is used.

The CMS-HCC model is prospective, meaning it uses conditions from a base year to predict beneficiary costs in the next year (the prediction year), as opposed to concurrent, which uses conditions diagnosed in the prediction year to predict costs in the same year (see text box on prospective risk adjustment).

The purpose of risk adjustment is not to accurately predict costs for any particular person, but on average for a group of people with the same attributes that affect health care

costs. Therefore, an underlying feature of the CMS–HCC model is that, for beneficiaries who have the same HCC, it predicts costs that are below actual costs for some beneficiaries (underpredicts) and predicts costs that are above actual costs for others (overpredicts), but predicts accurately on average. This result is a feature of all models that use beneficiaries’ conditions to predict costs. This risk of loss faced by plans provides an incentive for plans to manage their enrollees’ conditions to keep their costs down. In addition, by paying accurately for each condition on average, the CMS–HCC model reduces incentives for plans to avoid beneficiaries with high-cost conditions.

Changes required by the 21st Century Cures Act

The CMS–HCC model is based on the standard HCC model developed by CMS (Pope et al. 2000). The CMS–HCC model differs from the standard HCC model in that it does not include all of the HCCs from the standard model. CMS has chosen not to use all of the HCCs because the agency believes that exclusion of some HCCs has a minimal effect on model performance while reducing burden on plans to submit data on their enrollees’ conditions and on CMS to process the data. However, by excluding some HCCs from the CMS–HCC model, CMS runs the risk of systematic underpayments to plans for enrollees with those conditions. In addition, CMS has always included in the CMS–HCC model an adjustment for whether a Medicare beneficiary receives some benefits from the Medicaid program (dual-eligible beneficiaries). Historically, CMS did not distinguish between dual-eligible beneficiaries with full Medicaid benefits from their state of residence and those with partial Medicaid benefits (their state paid their Medicare premiums and, in some cases, some of their Medicare cost-sharing responsibilities). However, the cost to the Medicare program is higher, on average, among the full-benefit dual-eligible beneficiaries relative to the partial-benefit dual-eligible beneficiaries. Consequently, risk adjustment that does not distinguish between these two populations produces systematic underpayments for full-benefit dual-eligible beneficiaries and systematic overpayments for partial-benefit dual-eligible beneficiaries.

In an effort to improve the CMS–HCC model, the Congress in the 21st Century Cures Act directed the

Secretary to make three changes to the CMS–HCC model (see text box on mandates, pp. 102–103):

- Add indicators for the total number of diseases or conditions for each enrollee.
- Provide separate payment adjustments for beneficiaries who receive full Medicaid benefits and for beneficiaries who receive partial Medicaid benefits. Until 2017, the CMS–HCC model had provided the same payment adjustment for these two beneficiary groups.
- Evaluate the effects of including additional diagnosis codes for mental health disorders, substance abuse disorders, and chronic kidney disease.

In addition, the 21st Century Cures Act indicates that the Secretary “may use at least two years of diagnosis data” to determine risk scores. It does not appear that use of two years of data is required.

CMS has implemented three of these changes indicated in the 21st Century Cures Act, the exception being use of at least two years of data to determine risk scores, when available.

The 21st Century Cures Act also directs the Commission to conduct an evaluation of the impact of these changes to the CMS–HCC model. In this report, we evaluated versions of the CMS–HCC model that CMS has implemented in response to the requirements in the 21st Century Cures Act:

- ***Different adjustments for MA enrollees with full Medicaid benefits and those with partial Medicaid benefits.*** The version of the CMS–HCC model that CMS used before 2017 (version 21, or V21) did not distinguish between these two groups of beneficiaries. In 2017, CMS implemented a version of the CMS–HCC model (V22) that distinguished between these two Medicare populations receiving Medicaid assistance by creating separate models for six population segments—
 - full Medicaid benefits and eligible for Medicare because of disability (disabled);
 - full Medicaid benefits and eligible for Medicare because of age (aged);
 - partial Medicaid benefits and disabled;

- partial Medicaid benefits and aged;
- no Medicaid benefits and disabled;
- no Medicaid benefits and aged.
- **Add HCCs for mental health disorders, substance abuse disorders, and chronic kidney disease.** For 2019, CMS implemented a version of the CMS–HCC model (V23) that added HCCs for mental health disorders, substance abuse disorders, and chronic kidney disease to V22 of the CMS–HCC model. CMS continued to use the six population segments from V22 in V23.
- **Include variables for the number of diseases or conditions for each beneficiary.** For 2020, CMS implemented a version of the CMS–HCC model (V24.1) that added indicators for the number of conditions for each beneficiary to V23. CMS determines the number of conditions for each beneficiary by counting the number of “payment HCCs” for each enrollee. A payment HCC is one that CMS includes in the CMS–HCC model used for payment purposes. CMS continued to use the six population segments in V22 and V23.
- **Use at least two years of diagnosis data to determine risk scores.** CMS has not implemented a version of the CMS–HCC model that uses two years of diagnosis data to determine risk scores. Nevertheless, we created and evaluated a version of the CMS–HCC model (V24.2) that is the same as model V24.1, but uses two years of diagnosis data. This version uses the same population segments used in models V22, V23, and V24.1.

We focused our evaluation of the changes that CMS has made to the CMS–HCC model on how well the resulting versions predict costs for Medicare populations defined by indicators of their health. The purpose of risk adjustment is to (1) adjust payments to MA plans such that those payments accurately reflect how much each MA enrollee is expected to cost in terms of covered services in FFS Medicare and (2) pay accurately enough so that plans do not have an incentive to attract beneficiaries because they would be profitable and avoid other beneficiaries because they would not be profitable. If risk adjustment does not pay accurately enough, plans could use beneficiaries’ health characteristics such as their medical conditions, number of health conditions, and historical health care costs to distinguish the favorable risks from the unfavorable risks.

In our analysis, we evaluated how well the CMS–HCC models implemented by CMS predict costs for beneficiary groups defined by health characteristics:

- Beneficiaries who have common medical conditions, including acute myocardial infarction (AMI), cancer, congestive heart failure (CHF), chronic obstructive pulmonary disease (COPD), mental illness, schizophrenia, all strokes, and ischemic or unspecified strokes.
- Beneficiaries stratified into groups by number of medical conditions, as indicated by the number of HCCs.
- Beneficiaries stratified by Medicare program spending in the year before the beneficiary’s risk score is determined (base-year spending). We determined the distribution of Medicare program spending among all Medicare beneficiaries and identified the percentile of each beneficiary’s Medicare spending. We then stratified the beneficiaries into these seven percentile categories: lowest 20 percent, 20 percent to 40 percent, 40 percent to 60 percent, 60 percent to 80 percent, 80 percent to 95 percent, 95 percent to 99 percent, and highest 1 percent.

We used predictive ratios (PRs) to evaluate how well the different versions of the CMS–HCC model predict costs for these various groups of Medicare beneficiaries. PRs indicate how well a model predicts costs for a group of beneficiaries with the same health characteristics. For a group of beneficiaries, a PR is the cost for the group as predicted by a risk adjustment model divided by the actual cost for that group. A PR greater than 1.0 indicates predicted costs are greater than actual costs for a group (overprediction); a PR less than 1.0 indicates predicted costs are less than actual costs for a group (underprediction). For a discussion of the details of our data and methods, see the text box about estimating and evaluating (pp. 104–105).

Impacts of changes to CMS’s risk adjustment model for Medicare Advantage

Our results indicate that each of the required changes CMS has made to the CMS–HCC model improves the predictive accuracy for each of the beneficiary populations that are the focus of the changes. Creating separate

Mandates to the Secretary and the Commission to improve risk adjustment in the 21st Century Cures Act

The legislative language of Section 17006 of the 21st Century Cures Act directs the Secretary and the Commission to improve risk adjustment in the Medicare Advantage program as follows:

(f) IMPROVEMENTS TO RISK ADJUSTMENT UNDER MEDICARE ADVANTAGE.—

(1) IN GENERAL.—Section 1853(a)(1) of the Social Security Act (42 U.S.C. 1395w–23(a)(1)) is amended—

(A) in subparagraph (C)(i), by striking “The Secretary” and inserting “Subject to subparagraph (I), the Secretary”; and

(B) by adding at the end the following new subparagraph:

“(I) IMPROVEMENTS TO RISK ADJUSTMENT FOR 2019 AND SUBSEQUENT YEARS.—

“(i) IN GENERAL.—In order to determine the appropriate adjustment for health status under subparagraph (C)(i), the following shall apply:

“(I) TAKING INTO ACCOUNT TOTAL NUMBER OF DISEASES OR CONDITIONS.—The Secretary shall take into account the total number of

diseases or conditions of an individual enrolled in an MA plan. The Secretary shall make an additional adjustment under such subparagraph as the number of diseases or conditions of an individual increases.

“(II) USING AT LEAST 2 YEARS OF DIAGNOSTIC DATA.—The Secretary may use at least 2 years of diagnosis data.

“(III) PROVIDING SEPARATE ADJUSTMENTS FOR DUAL ELIGIBLE INDIVIDUALS.—With respect to individuals who are dually eligible for benefits under this title and title XIX, the Secretary shall make separate adjustments for each of the following:

“(aa) Full-benefit dual eligible individuals (as defined in section 1935(c)(6)).

“(bb) Such individuals not described in item (aa).

“(IV) EVALUATION OF MENTAL HEALTH AND SUBSTANCE USE DISORDERS.—The Secretary shall evaluate the impact of including

(continued next page)

versions of the model for partial Medicaid beneficiaries and full Medicaid beneficiaries produces more accurate predictions of the cost of these beneficiaries. Further, adding indicators for mental health disorders, substance abuse disorders, and chronic kidney disease improves how well the CMS–HCC predicts the cost of beneficiaries who have these conditions. However, the addition of those indicators may increase opportunities for plans to boost revenue through more intensive coding. Finally, adding

measures of the number of conditions for each beneficiary improves how well the CMS–HCC model predicts the cost of beneficiaries who have 10 or more conditions.

We also found that using two years of diagnosis data to determine beneficiaries’ conditions produces payment adjustments that are about as accurate as using one year of diagnosis data, though this model produces larger underpayments for those with high levels of Medicare spending than using one year of diagnosis

Mandates to the Secretary and the Commission to improve risk adjustment in the 21st Century Cures Act (cont.)

additional diagnosis codes related to mental health and substance use disorders in the risk adjustment model.

“(V) EVALUATION OF CHRONIC KIDNEY DISEASE.—The Secretary shall evaluate the impact of including the severity of chronic kidney disease in the risk adjustment model.

“(ii) PHASED-IN IMPLEMENTATION.—The Secretary shall phase-in any changes to risk adjustment payment amounts under subparagraph (C)(i) under this subparagraph over a 3-year period, beginning with 2019, with such changes being fully implemented for 2022 and subsequent years.

“(iii) OPPORTUNITY FOR REVIEW AND PUBLIC COMMENT.—The Secretary shall provide an opportunity for review of the proposed changes to such risk adjustment payment amounts under this subparagraph and a public comment period of not less than 60 days before implementing such changes.”.

(2) STUDIES AND REPORTS.—

(A) REPORTS ON THE RISK ADJUSTMENT SYSTEM.—

(i) MEDPAC EVALUATION AND REPORT.—

(I) EVALUATION.—The Medicare Payment Advisory Commission shall conduct an evaluation of the impact of the provisions of, and amendments made by, this section on risk scores for enrollees in Medicare Advantage plans under part C of title XVIII of the Social Security Act and payments to Medicare Advantage plans under such part, including the impact of such provisions and amendments on the overall accuracy of risk scores under the Medicare Advantage program.

(II) REPORT.—Not later than July 1, 2020, the Medicare Payment Advisory Commission shall submit to Congress a report on the evaluation under subclause (I), together with recommendations for such legislation and administrative action as the Commission determines appropriate. ■

data. Nevertheless, in our view, the use of two years of diagnosis data would be beneficial for MA risk adjustment because it would decrease the extent of coding differences that persist between the MA and FFS sectors of the Medicare program. Using two years of diagnosis data allows the model to capture more medical conditions among the FFS population, so that the profile of conditions among the FFS population more closely matches the profile of conditions that would have been recorded for those beneficiaries had they been enrolled in MA. The result would be reduced payment errors that occur because of coding differences between MA and FFS.

Separate adjustments for fully dual beneficiaries and partially dual beneficiaries improves cost predictions

Since CMS began using the CMS–HCC model in 2004, CMS has included an adjustment for beneficiaries who are also eligible for Medicaid (Centers for Medicare & Medicaid Services 2003). However, being dually eligible does not mean all these enrollees have the same level of Medicaid coverage. Some have full benefits (FBs) from their state of residence, including prescription drugs, while others have only partial benefits (PBs), such as assistance with Medicare cost sharing and Medicare premiums. The

Method for estimating and evaluating versions of the CMS–HCC model

We used a sample of 27.2 million beneficiaries in fee-for-service (FFS) Medicare to evaluate five versions of the CMS hierarchical condition category (CMS–HCC) model, which CMS uses to risk adjust payments to Medicare Advantage (MA) plans. We randomly selected half this sample—13.6 million beneficiaries—to estimate coefficients in the five model versions:

- The version of the CMS–HCC model that CMS used in the MA program before 2017 (V21).
- The version of the CMS–HCC model that CMS used in the MA program in 2017 and 2018 (V22). This model is largely the same as V21, but CMS created separate adjustments for Medicare full-benefit dual-eligible beneficiaries (full Medicaid benefits from their state of residence) and for partial-benefit dual-eligible beneficiaries (their state pays their Medicare premiums plus cost sharing in some instances).
- The version of the CMS–HCC model that CMS used in the MA program in 2019 (V23). This model is largely V22, but CMS modified or added new hierarchical condition categories (HCCs) for moderate to severe substance abuse, minor substance abuse, reactive and unspecified psychosis, personality disorder, and Stage 3 chronic kidney disease.
- Model V24.1, which CMS began using in 2020, is V23 with additional categories for the number of conditions for each beneficiary. CMS defined the number of conditions as the number of HCCs that each beneficiary’s medical diagnoses map into.
- Model V24.2 (which is V24.1, but instead of using one year of diagnosis data to determine each beneficiary’s HCCs, V24.2 uses two years of diagnosis data when available). The Commission developed this model for this study.

We used the other half of the sample (13.6 million FFS beneficiaries) to evaluate model performance using predictive ratios (PRs), which indicate how well a model predicts costs for a group of beneficiaries

with the same health characteristics. For a group of beneficiaries, a PR is the cost for the group as predicted by a risk adjustment model divided by the actual cost for that group. A PR greater than 1.0 indicates predicted costs are greater than actual costs for a group (overprediction); a PR of less than 1.0 indicates predicted costs are less than actual costs for a group (underprediction). For this analysis, the prediction year is 2017, which is the year for which we are predicting beneficiaries’ costs. The previous year (2016) is the base year from which we draw beneficiaries’ conditions to determine their HCCs, except for V24.2, which has two base years (2015 and 2016) because we used two years of diagnosis data to determine HCCs.

All beneficiaries in our sample had Part A and Part B coverage in FFS Medicare in every month of 2016 (the sample for model V24.2 had Part A and Part B coverage in every month of 2015 and 2016). Beneficiaries must have lived within the 50 U.S. states throughout 2016 and must not have had Medicare as a secondary payer in 2016. In 2017, beneficiaries must have been in FFS Medicare for at least one month, must not have had Medicare as a secondary payer, must not have had end-stage renal status, must have lived within the 50 U.S. states throughout their enrollment in FFS Medicare, and must not have received hospice care.

For each beneficiary, we determined the months in 2017 during which the beneficiary was in a long-term care facility (living in an institution) and the months during which they were not (living in the community). During each of the months in which a beneficiary was living in the community in 2017, we assigned beneficiaries to one of these population segments:

- Full Medicaid benefits and eligible for Medicare because of disability (FULL_BENEFIT_DISABLED)
- Full Medicaid benefits and eligible for Medicare because of age (FULL_BENEFIT_AGED)
- Partial Medicaid benefits and eligible for Medicare because of disability (PARTIAL_BENEFIT_DISABLED)

(continued next page)

Method for estimating and evaluating versions of the CMS–HCC model (cont.)

- Partial Medicaid benefits and eligible for Medicare because of age (PARTIAL_BENEFIT_AGED)
- No Medicaid benefits and eligible for Medicare because of disability (NONDUAL_DISABLED)
- No Medicaid benefits and eligible for Medicare because of age (NONDUAL_AGED)

We assigned beneficiaries living in an institution to their own population segment, regardless of Medicaid status. For V22, V23, V24.1, and V24.2, we estimated separate versions for the seven population segments (institutionalized, FULL_BENEFIT_DISABLED, FULL_BENEFIT_AGED, PARTIAL_BENEFIT_DISABLED, PARTIAL_BENEFIT_AGED, NONDUAL_DISABLED, and NONDUAL_AGED).

For each beneficiary in our sample, we created the following variables for the regressions we used to estimate the coefficients (which indicate the additional cost of a characteristic or condition):

- The 2017 costs to the Medicare program incurred while in FFS Medicare. For each beneficiary, we divided these costs into the months the beneficiary was in each of the seven population segments (institutionalized, FULL_BENEFIT_DISABLED, FULL_BENEFIT_AGED, PARTIAL_BENEFIT_DISABLED, PARTIAL_BENEFIT_AGED, NONDUAL_DISABLED, and NONDUAL_AGED). We annualized these costs by dividing them by the fraction of 2017 that the beneficiary was in each of these segments.

- 24 age/sex categories for 2017
- Two categories—one for male, one for female—indicating whether a beneficiary was eligible for Medicare in 2017 because of age but was originally eligible because of disability
- The HCCs for each version of the model
- Disease interaction terms created from beneficiaries' HCCs
- For the institutional population, disabled/disease interaction terms

In estimating each model's coefficients, we used the beneficiaries' annualized 2017 FFS costs as the dependent variable and the remaining variables listed above as the explanatory variables in a weighted least squares regression. The weights were the fraction of 2017 that each beneficiary was in each of the seven population segments.

After estimating coefficients for V21, V22, V23, V24.1, and V24.2, we evaluated their efficacy using half of the 27.2 million-person full sample that we did not use to estimate the models. For each beneficiary, we determined the 2017 Medicare costs predicted by each of the five versions. We used these 2017 predicted costs to calculate PRs in nine disease categories, five HCCs that CMS introduced or modified for V23, seven categories that represent levels of beneficiaries' FFS costs in the base year of 2016, and nine categories that represent the number of conditions for beneficiaries in 2017. ■

versions of the CMS–HCC model that CMS used before 2017 did not distinguish between the FB beneficiaries and the PB beneficiaries, adjusting the capitated payments to MA plans by the same rate for all dual-eligible beneficiaries.

Research indicates that when the CMS–HCC model does not distinguish between FB beneficiaries and PB beneficiaries, the model systematically underpredicts

the cost for FB beneficiaries and overpredicts the cost for PB beneficiaries. For this analysis, we estimated how well CMS–HCC V21—which does not distinguish FB beneficiaries from PB beneficiaries—predicts costs for those two groups. Our analysis estimates an underprediction of 5 percent for FB beneficiaries and an overprediction of 5 percent for PB beneficiaries. In response to these systematic payment inaccuracies, CMS

made substantial changes to the CMS–HCC model for 2017. CMS replaced the single model for all enrollees that CMS identifies as living in the community (V21) by separating beneficiaries living in the community into population segments defined by their Medicaid eligibility status and their reason for Medicare eligibility (aged or disabled):

- full Medicaid benefits and eligible for Medicare because of disability (FULL_BENEFIT_DISABLED)
- full Medicaid benefits and eligible for Medicare because of age (FULL_BENEFIT_AGED)
- partial Medicaid benefits and eligible for Medicare because of disability (PARTIAL_BENEFIT_DISABLED)
- partial Medicaid benefits and eligible for Medicare because of age (PARTIAL_BENEFIT_AGED)
- no Medicaid benefits and eligible for Medicare because of disability (NONDUAL_DISABLED)
- no Medicaid benefits and eligible for Medicare because of age (NONDUAL_AGED)

CMS has also maintained a distinct version of the CMS–HCC model for enrollees who lived in an institutional facility (primarily nursing homes) for at least three consecutive months in the prediction year. Therefore, we evaluated how well risk adjustment predicts costs for seven population segments: six population segments in the community that are distinguished by their Medicaid status and whether they are Medicare eligible because of age or disability and one population segment for the long-term institutionalized.

We determined PRs for each of the versions for the six community population segments and for the institutional population. For all seven population segments, we found that V22 produced PRs of 1.00 for the entire population in the model.² These results indicate that the model pays accurately for each of the population segments, on average. In other words, separately estimating the model for each of the six population segments results in accurate payments for both beneficiaries who have full Medicaid benefits and beneficiaries who have partial Medicaid benefits (as well as those who have no Medicaid benefits). These accurate payments for population segments are an improvement over the single version of the CMS–

HCC model that CMS used for the community and institutionalized populations before 2017 (V21).

We also evaluated how well CMS–HCC model V22 predicts costs for groups of beneficiaries defined by other health characteristics. For each of the six community population segments and the institutional population, we:

- grouped beneficiaries by several medical conditions in the base year (AMI, cancer, CHF, COPD, diabetes, mental illness, schizophrenia, all stroke, and ischemic or unspecified stroke);
- stratified beneficiaries by the number of medical conditions, as indicated by the number of HCCs;
- stratified beneficiaries by their cost to the Medicare program in the base year of 2016; and
- grouped beneficiaries by whether they had one of the HCCs that CMS added to or modified for the CMS–HCC model in 2019 (moderate to severe substance abuse, mild substance abuse, reactive and unspecified psychosis, personality disorder, and Stage 3 chronic kidney disease).

We chose these health characteristics because they can be observed by plans, and, therefore, plans can use these characteristics to select enrollees. Plans cannot use other characteristics such as beneficiaries’ cost to the Medicare program in the prediction year (2017 for this study) because the plans cannot observe these characteristics before beneficiaries make their decisions about MA enrollment.

We found that V22 predicts accurately in each population segment for the conditions included in the model (Table 4-1, p. 108). The greatest degree of underprediction is for schizophrenia among the FULL_BENEFIT_AGED segment (PR = 0.97), and the greatest degree of overprediction is for AMI among the FULL_BENEFIT_DISABLED and NONDUAL_AGED segments (PR = 1.02). However, neither result indicates a large payment inaccuracy.

When we stratified beneficiaries by the number of conditions they had (which is not a variable in V22 but which CMS added for V24.1), we found that for each of the seven population segments, V22 predicted well for beneficiaries who had from one condition to eight conditions. However, we found some degree of underprediction in all population segments for beneficiaries with no conditions indicated in the model

(PR as low as 0.83 in the FULL_BENEFIT_DISABLED segment) and for beneficiaries with many conditions (PR as low as 0.90 for the NONDUAL_DISABLED segment who have 12 or more conditions). It may be counterintuitive that V22 underpredicted costs for a population that appeared to be quite healthy, those with no conditions indicated in the model. This underprediction occurred because many of these beneficiaries do have medical conditions, but the conditions are not included in V22; the model does not adjust payments for those medical conditions. This underprediction occurs in the other versions we evaluated for the same reason.³

We also included in Table 4-1 (p. 108) PRs for beneficiaries with conditions not included in V22 but which CMS added to V23 in 2019 (moderate to severe substance abuse, mild substance abuse, reactive and unspecified psychosis, personality disorder, and Stage 3 chronic kidney disease). In general, PRs for these conditions are less than 1.0, indicating costs are underpredicted. This result is not surprising. If a risk adjustment model does not account for a medical condition, there is no payment adjustment if a beneficiary has that condition.

Finally, when we stratified beneficiaries in each population segment by their Medicare spending in the base year, we found that for each population segment model, V22 systematically overpredicted the cost of beneficiaries with low Medicare spending in the base year and underpredicted the cost of beneficiaries with high Medicare spending in the base year. For example, under V22 for the FULL_BENEFIT_DISABLED segment, the PR for those with base-year spending in the lowest 20 percent was 1.47, indicating an average overpayment of 47 percent. At the same time, the PR for those with base-year spending at the 99th percentile or higher was 0.63, indicating an average underpayment of 37 percent. Large, systematic underpayments and overpayments are an incentive for MA plans to encourage the enrollment of beneficiaries for whom plans are systematically overpaid and discourage enrollment of beneficiaries for whom plans are systematically underpaid.

In summary, we found that V22 predicts costs well for each of the seven population segments and for groups of beneficiaries within those population segments who have conditions included in V22 (AMI, cancer, and so

on). However, CMS–HCC model V22 does not predict as accurately when we group beneficiaries by variables not in the model.

Adding variables for substance abuse disorders, mental health disorders, and chronic kidney disease to the models improves cost prediction for those conditions but could increase coding opportunities

In 2019, CMS implemented a new version of the CMS–HCC model—V23—after making several changes to the HCCs in V22, which included new HCCs for mild substance abuse, reactive and unspecified psychosis, personality disorder, and Stage 3 chronic kidney disease. In addition, CMS expanded the HCC for moderate to severe substance abuse by adding more diagnoses that map to that HCC. For V23, CMS continued to provide separate estimates for the seven population segments used in V22.

We find that—relative to V22—V23 improved prediction for some beneficiary groups and had similar predictions for other beneficiary groups. We expected that V23 would produce better PRs than V22 for the beneficiaries with diagnoses that map into the five HCCs that CMS added to or expanded for V23. For example, the predictive ratios under V22 for the six community population segments ranged from 0.80 to 0.89 for reactive or unspecified psychosis (Table 4-1, p. 108). Under V23, the PRs for reactive or unspecified psychosis improved in all of the population segments, ranging from 0.97 to 1.00 (Table 4-2, p. 109). Despite the general improvement in PRs for these five HCCs under V23, the PRs in Table 4-2 are still well below 1.00 in some instances, such as a PR of 0.84 for personality disorder in the PARTIAL_BENEFIT_AGED population. In our view, these low PRs are not a sign of poor performance by V23. Instead, we attribute the few low PRs among these five HCCs to small numbers of beneficiaries who have these conditions. For example, we used a sample of 13.6 million to evaluate PRs, but only 271 beneficiaries who were in the PARTIAL_BENEFIT_AGED segment had the HCC for personality disorder. Under samples that small, a few beneficiaries with very high costs or very low costs can substantially affect the level of the PR. For example, the two highest cost beneficiaries in the sample we used to determine PRs had costs of \$427,000 and \$330,000, while the highest cost beneficiary in the sample we used to estimate V23 had costs of \$253,000.

**TABLE
4-1**

Predictive ratios for CMS-HCC model V22

Beneficiary category	Full Medicaid		Partial Medicaid		No Medicaid		LTI
	Disabled	Aged	Disabled	Aged	Disabled	Aged	
R^2	0.123	0.116	0.081	0.105	0.080	0.122	0.096
Conditions in model V22							
AMI	1.02	0.99	0.99	1.00	0.98	1.02	1.02
Cancer	1.01	1.00	1.01	0.99	0.99	1.00	1.01
CHF	1.02	1.00	1.01	1.00	0.99	1.00	1.01
COPD	1.01	1.00	1.00	1.00	1.00	1.00	1.00
Diabetes	1.01	1.00	1.00	1.00	1.01	1.00	1.00
Mental illness	1.00	1.00	1.00	0.98	1.00	1.00	1.01
Schizophrenia	1.00	0.97	0.99	0.99	1.00	0.98	1.01
All stroke	0.99	0.98	1.02	0.98	0.98	0.99	1.01
Ischemic or unspecified stroke	0.99	0.98	1.02	0.98	0.98	1.00	1.00
Number of conditions (added in model V24.1)							
No conditions	0.83	0.90	0.89	0.92	0.86	0.96	0.82
1 condition	0.98	1.02	1.01	1.01	1.00	1.01	0.98
2 conditions	1.02	1.02	1.02	1.02	1.04	1.02	1.02
3 conditions	1.04	1.02	1.02	1.01	1.05	1.01	1.02
4 conditions	1.03	1.02	1.03	1.02	1.04	1.01	1.03
5 or more conditions	1.01	1.00	1.00	1.00	1.00	1.00	1.00
8 or more conditions	0.99	0.97	0.98	0.96	0.95	0.97	0.99
10 or more conditions	0.97	0.95	0.95	0.93	0.93	0.96	0.99
12 or more conditions	0.95	0.94	0.94	0.92	0.90	0.94	0.98
Percentile of base-year cost							
0 to 20 percentile	1.47	1.04	1.40	1.12	1.72	1.29	0.84
20 to 40 percentile	1.54	1.37	1.53	1.34	1.67	1.33	1.51
40 to 60 percentile	1.27	1.24	1.24	1.17	1.23	1.13	1.32
60 to 80 percentile	1.06	1.05	1.04	1.01	0.97	0.96	1.04
80 to 95 percentile	0.92	0.91	0.92	0.88	0.83	0.88	0.96
95 to 99 percentile	0.79	0.86	0.76	0.83	0.68	0.82	0.93
99 percentile and higher	0.63	0.76	0.58	0.69	0.50	0.67	0.83
Conditions added in 2019 for model V23							
Substance abuse, moderate to severe	0.99	0.97	1.00	0.96	1.01	0.99	0.99
Substance abuse, mild	0.76	0.80	0.84	0.72	0.78	0.83	0.85
Reactive and unspecified psychosis	0.89	0.81	0.86	0.80	0.81	0.81	0.98
Personality disorder	0.91	0.82	0.75	0.81	0.88	0.79	1.00
Chronic kidney disease, Stage 3	0.93	0.97	1.01	0.96	0.94	0.95	0.97
Number of beneficiary years (in thousands)							
	852	781	305	337	826	9,662	290

Note: CMS-HCC (CMS-hierarchical condition category), V (version), LTI (long-term institutionalized), AMI (acute myocardial infarction), CHF (congestive heart failure), COPD (chronic obstructive pulmonary disease). V22, V23, and V24.1 are versions of the CMS-HCC model that CMS used in 2017 and 2018; 2019; and 2020, respectively. We define "number of conditions" for each beneficiary as the number of HCCs for that beneficiary. "Base-year cost" is the cost to fee-for-service Medicare for each beneficiary in the base year of our analysis, 2016. "Conditions added in 2019" are the HCCs that CMS added to the CMS-HCC model in 2019. "Number of beneficiary years" is the sum across all beneficiaries in our analytic file of the fraction of the prediction year (2017) that each beneficiary was in both Part A and Part B of fee-for-service Medicare.

Source: MedPAC analysis of the version of the CMS-HCC model that CMS used to risk adjust MA payments in 2017 and 2018. Data used in this analysis include all standard analytic claims files for the inpatient, outpatient, and physician sectors in 2016; standard analytic claims for all sectors in 2017; Medicare denominator files for 2016 and 2017; and the custom Medicare enrollment file.

**TABLE
4-2**

Predictive ratios for CMS-HCC model V23, which adds HCCs for substance abuse disorders, mental health disorders, and kidney disease

Beneficiary category	Full Medicaid		Partial Medicaid		No Medicaid		LTI
	Disabled	Aged	Disabled	Aged	Disabled	Aged	
R^2	0.124	0.117	0.081	0.106	0.080	0.123	0.096
Conditions in model V22							
AMI	1.02	0.99	0.99	1.00	0.98	1.00	1.02
Cancer	1.01	1.00	1.01	0.99	0.99	1.00	1.01
CHF	1.01	1.00	1.01	1.00	1.00	1.00	1.01
COPD	1.01	1.00	1.00	1.00	1.00	1.00	1.00
Diabetes	1.01	1.00	1.00	1.00	1.01	1.00	1.00
Mental illness	1.00	1.00	1.00	0.99	1.01	1.00	1.01
Schizophrenia	1.00	0.97	0.99	1.00	1.01	0.98	1.01
All stroke	0.99	0.98	1.02	0.98	0.98	0.99	1.01
Ischemic or unspecified stroke	0.99	0.97	1.01	0.98	0.98	1.00	1.00
Number of conditions (added in model V24.1)							
No conditions	0.83	0.90	0.89	0.92	0.86	0.96	0.81
1 condition	0.98	1.02	1.00	1.01	1.00	1.01	0.99
2 conditions	1.02	1.01	1.02	1.01	1.04	1.01	1.02
3 conditions	1.03	1.02	1.02	1.01	1.06	1.01	1.02
4 conditions	1.03	1.02	1.03	1.01	1.05	1.01	1.02
5 or more conditions	1.01	1.00	1.01	1.00	1.00	1.00	1.00
8 or more conditions	0.99	0.97	0.97	0.97	0.96	0.98	0.99
10 or more conditions	0.97	0.96	0.95	0.94	0.93	0.96	0.99
12 or more conditions	0.96	0.93	0.95	0.91	0.91	0.94	0.98
Percentile of base-year cost							
0 to 20 percentile	1.45	1.02	1.39	1.11	1.72	1.28	0.84
20 to 40 percentile	1.53	1.36	1.52	1.33	1.67	1.33	1.51
40 to 60 percentile	1.26	1.23	1.24	1.16	1.23	1.13	1.32
60 to 80 percentile	1.06	1.05	1.04	1.01	0.97	0.96	1.04
80 to 95 percentile	0.92	0.92	0.92	0.89	0.83	0.88	0.96
95 to 99 percentile	0.79	0.86	0.77	0.83	0.68	0.82	0.93
99 percentile and higher	0.63	0.76	0.58	0.69	0.50	0.67	0.83
Conditions added in 2019 for model V23							
Substance abuse, moderate to severe	1.00	0.98	1.01	0.97	1.03	0.99	0.99
Substance abuse, mild	0.95	0.94	1.06	0.86	1.03	1.00	0.85
Reactive and unspecified psychosis	0.97	0.98	0.99	1.00	1.00	0.99	0.99
Personality disorder	1.04	0.93	0.83	0.84	1.05	0.93	1.00
Chronic kidney disease, Stage 3	1.00	1.00	1.07	1.00	1.00	1.00	0.97
Number of beneficiary years (in thousands)							
	852	781	305	337	826	9,662	290

Note: CMS-HCC (CMS-hierarchical condition category), V (version), LTI (long-term institutionalized), AMI (acute myocardial infarction), CHF (congestive heart failure), COPD (chronic obstructive pulmonary disease). V22, V23, and V24.1 are versions of the CMS-HCC model that CMS used in 2017 and 2018; 2019; and 2020, respectively. We define "number of conditions" for each beneficiary as the number of HCCs for that beneficiary. "Base-year cost" is the cost to fee-for-service Medicare for each beneficiary in the base year of our analysis, 2016. "Conditions added in 2019" are the HCCs that CMS added to the CMS-HCC model in 2019. "Number of beneficiary years" is the sum across all beneficiaries in our analytic file of the fraction of the prediction year (2017) that each beneficiary was in both Part A and Part B of fee-for-service Medicare.

Source: MedPAC analysis of the version of the CMS-HCC model that CMS used to risk adjust MA payments in 2019. Data used in this analysis include all standard analytic claims files for the inpatient, outpatient, and physician sectors in 2016; standard analytic claims for all sectors in 2017; Medicare denominator files for 2016 and 2017; the custom Medicare enrollment file; and Medicare risk adjustment files for 2017.

Despite the improvement in performance for beneficiaries in the five HCCs added to V23, when we stratified beneficiaries by the number of conditions they had (a variable not in V23 but added to V24.1 by CMS), we found some degree of underprediction in all population segments for beneficiaries with no conditions (PR as low as 0.83 in the FULL_BENEFIT_DISABLED segment) and for beneficiaries with many conditions (PRs as low as 0.91 for the PARTIAL_BENEFIT_AGED and NONDUAL_DISABLED segments who have 12 or more conditions) (Table 4-2, p. 109).

We also caution that adding HCCs to the model can increase opportunities for MA plans to code more intensively to increase revenue, especially if the additional HCCs represent conditions that are diagnosed using relatively discretionary standards (meaning there is more than minimal provider discretion when assigning the code). The HCCs that CMS added for V23 can be considered discretionary. Previously, CMS addressed coding intensity by removing HCCs from the model that the agency suspected were being aggressively coded by plans, including HCCs for lower severity chronic kidney disease. Empirical analyses indicate that removal of these HCCs reduced the average risk scores of MA enrollees, suggesting that it helped offset the effects of coding intensity (Kronick and Welch 2014, Medicare Payment Advisory Commission 2019b). The decision by CMS to add Stage 3 chronic kidney disease to V23 reintroduces one of the HCCs that CMS had previously removed.

In summary, we found that V23 predicts costs well for each of the population segments of dually eligible beneficiaries and for groups of beneficiaries within those population segments who have conditions included in V23 (AMI, cancer, and so on), including the beneficiaries who have conditions in the five HCCs added to V23. However, V23 does not predict accurately when we group beneficiaries by variables that are not in V23: the number of conditions they have and their Medicare program spending in the base year. In addition, we are concerned that including the five HCCs may encourage plans to increase revenues through more intensive coding by coding more discretionary medical conditions.

Adding the number of medical conditions for each beneficiary improves cost prediction

For 2020, CMS made another change to the CMS–HCC model by adding the number of conditions for each beneficiary to model V23, which resulted in V24.1. CMS

determined the number of conditions for each beneficiary as the number of HCCs that the beneficiary has in V24.1. For example, if a beneficiary had medical diagnoses that map to HCC 19 (diabetes without complications), HCC 85 (congestive heart failure), and HCC 111 (chronic obstructive pulmonary disease), CMS would determine this beneficiary has three medical conditions. CMS continued to produce separate estimates for the six community-based population segments. CMS did not add number of conditions for the institutional population, so we excluded that population from this part of our analysis.

The method we used to estimate the coefficients for V24.1 for each of the six population segments was similar to the method used by CMS. Important features of that method include:

- The number of conditions for a beneficiary is the number of HCCs indicated in the CMS–HCC model, not the number of HCCs in the full HCC model.
- We used 0/1 dichotomous variables for each number of conditions. That is, for the “one condition” category, beneficiaries who had one condition received a “1” and all other beneficiaries received a “0.” For the “two conditions” category, beneficiaries who had two conditions received a “1” and all other beneficiaries received a “0,” and so on.
- When we included the indicators for the number of conditions in our regression analysis, the categories representing fewer than four to six conditions—depending on the population segment—had negative coefficients. CMS had a similar finding.
- To be consistent with CMS, we excluded from V24.1 the indicators for the number of conditions that had negative coefficients. This approach resulted in the smallest indicator for number of conditions being four conditions for NONDUAL_AGED, five conditions for FULL_BENEFIT_DISABLED, PARTIAL_BENEFIT_DISABLED, PARTIAL_BENEFIT_AGED, and NONDUAL_DISABLED; and six conditions for FULL_BENEFIT_AGED.

Adding the number of conditions to the CMS–HCC model improves how well the model predicts costs for beneficiaries with no conditions and for those with many conditions (10 or more). For example, for the NONDUAL_DISABLED population segment (no Medicaid benefits, disabled), the PRs increased from 0.86

under V23 (Table 4-2, p. 109) to 0.94 under V24.1 for beneficiaries with no conditions (Table 4-3, p. 112), and from 0.91 under V23 (Table 4-2) to 0.94 under V24.1 for beneficiaries with 12 or more conditions (Table 4-3). Moreover, when we stratify beneficiaries by their program spending in the base year, V24.1 produces slightly better PRs relative to V23 for beneficiaries with very high levels of base-year costs (top 1 percent). Despite this slight improvement, PRs for this beneficiary group are still far from 1.00 under model V24.1.

Using two years of diagnosis data helps address coding intensity issues but slightly worsens cost prediction for beneficiaries with high spending

To date, CMS has not implemented a version of the CMS–HCC model that uses two years of beneficiaries’ diagnosis data to determine their HCCs and risk scores rather than the single year of data that CMS has used for all CMS–HCC models, including those we evaluated in this report.

To evaluate the effects of using two years of diagnosis data, we applied two years of diagnosis data to model V24.1, calling it model V24.2. One caveat: We used the same beneficiary sample to evaluate V22, V23, and V24.1 (27.2 million FFS beneficiaries), but we used a subset of that sample to evaluate V24.2 (24.7 million FFS beneficiaries). The reason is that in a given year, the number of beneficiaries who have two years of diagnosis data is less than the number of beneficiaries who have one year of diagnosis data from the Medicare FFS claims we use in this analysis.

For most of the groups and population strata we evaluated, the PRs from V24.2 are similar to the PRs from V24.1. However, we found worse (lower) PRs under V24.2 relative to V24.1 for beneficiaries with high Medicare spending in the base year of 2016—above the 95th percentile (Table 4-4, p. 113).

The PRs for beneficiaries who had high base-year spending are worse when we use two years of diagnosis data because of a combination of two factors:

- The coefficients for most HCCs in the CMS–HCC model are lower when we use two years of data than when we use one year of data.
- Beneficiaries with high base-year spending often have a high number of HCCs.

For these beneficiaries, the lower coefficients on the HCCs under two years of data produce lower risk scores (which indicate lower predicted costs). For example, a beneficiary in our analytic file had 12 HCCs recorded under one year of data and 13 HCCs recorded under two years of data. These HCCs produced a risk score of 5.87 under one year of data and 5.10 under two years of data, a decrease of 0.77, even though this beneficiary had more HCCs under two years of diagnosis data. The coefficients on HCCs and, consequently, risk scores decline under two years of diagnosis data because using two years of data captures beneficiaries with less severe cases of a given condition. These less severe cases are less costly to treat, which results in lower coefficients on the related HCCs.

Despite the decrease in the PRs for beneficiaries who have high base-year Medicare spending when using two years of diagnosis data, we believe use of two years of diagnosis data would be beneficial for MA risk adjustment because it would decrease the extent of coding differences that persist between the MA and FFS sectors of the Medicare program. When we use only one year of diagnosis data, beneficiaries are likely to have more medical conditions recorded in their medical record if they are in MA than if they are in FFS Medicare. This discrepancy in coding between sectors does not mean that providers in the MA program or in the FFS program are improperly coding conditions. This discrepancy points to a difference in incentives between the two sectors. In the MA program, payments to plans are heavily dependent on the conditions that providers record for a beneficiary. Hence, MA plans have an incentive to encourage providers to code all the conditions that an enrollee has. In the FFS program, payment for services provided in physician offices or hospital outpatient departments largely depends on the services provided, while the conditions treated do not affect payment. At the same time, payment for services provided in the hospital inpatient setting depends on the patient’s conditions, but in 2017, only 18.5 percent of FFS beneficiaries had at least one inpatient stay (Medicare Payment Advisory Commission 2019a). Hence, in most of the encounters that FFS beneficiaries have with health care providers, there is little incentive for providers to record all of a beneficiary’s conditions.

The action of risk adjustment is to adjust the payment for each MA enrollee by the percentage that the enrollee would be expected to cost in FFS Medicare relative to the national average. That is, if an MA enrollee has demographic data and HCCs that indicate that the enrollee would cost 20 percent more in FFS Medicare than the

**TABLE
4-3**

Predictive ratios for CMS-HCC model V24.1, which adds the number of conditions

Beneficiary category	Full Medicaid		Partial Medicaid		No Medicaid	
	Disabled	Aged	Disabled	Aged	Disabled	Aged
R^2	0.124	0.118	0.081	0.106	0.081	0.123
Conditions in model V22						
AMI	1.03	0.99	0.99	1.01	0.98	1.00
Cancer	1.01	1.00	1.01	1.00	0.99	1.00
CHF	1.01	1.00	1.01	1.00	0.99	1.00
COPD	1.01	1.00	1.00	1.00	1.00	1.00
Diabetes	1.01	1.00	1.00	1.00	1.01	1.00
Mental illness	1.00	1.00	1.00	1.00	1.01	1.00
Schizophrenia	1.00	0.97	0.99	1.00	1.00	0.98
All stroke	0.99	0.99	1.02	0.99	0.97	0.99
Ischemic or unspecified stroke	0.99	0.97	1.02	0.99	0.98	0.99
Number of conditions (added in model V24.1)						
No conditions	0.92	0.92	0.94	0.96	0.94	0.98
1 condition	1.00	1.04	1.03	1.02	1.02	1.02
2 conditions	1.01	1.02	1.02	1.01	1.01	1.00
3 conditions	1.00	1.01	1.00	0.99	1.00	0.99
4 conditions	0.99	1.01	1.00	0.98	0.98	1.00
5 or more conditions	1.01	0.99	1.01	1.00	1.01	1.00
8 or more conditions	1.03	0.99	1.01	1.00	1.00	1.00
10 or more conditions	1.02	0.98	1.00	0.99	0.99	1.00
12 or more conditions	0.98	0.96	0.97	0.94	0.94	0.97
Percentile of base-year cost						
0 to 20 percentile	1.52	1.04	1.43	1.14	1.78	1.30
20 to 40 percentile	1.55	1.37	1.54	1.35	1.68	1.34
40 to 60 percentile	1.27	1.24	1.24	1.16	1.22	1.13
60 to 80 percentile	1.05	1.05	1.03	1.00	0.95	0.96
80 to 95 percentile	0.90	0.91	0.91	0.88	0.82	0.87
95 to 99 percentile	0.79	0.86	0.77	0.84	0.69	0.82
99 percentile and higher	0.65	0.77	0.59	0.70	0.51	0.68
Conditions added in 2019 for model V23						
Substance abuse, moderate to severe	1.00	0.98	1.01	0.99	1.01	0.99
Substance abuse, mild	0.95	0.94	1.06	0.88	1.01	1.00
Reactive and unspecified psychosis	0.97	0.98	0.99	1.01	0.99	0.99
Personality disorder	1.04	0.93	0.83	0.88	1.04	0.93
Chronic kidney disease, Stage 3	1.00	1.00	1.07	1.00	1.00	1.00
Number of beneficiary years (in thousands)						
	852	781	305	337	826	9,662

Note: CMS-HCC (CMS-hierarchical condition category), V (version), AMI (acute myocardial infarction), CHF (congestive heart failure), COPD (chronic obstructive pulmonary disease). V22, V23, and V24.1 are versions of the CMS-HCC model that CMS used in 2017 and 2018; 2019; and 2020, respectively. We define "number of conditions" for each beneficiary as the number of HCCs for that beneficiary. "Base-year cost" is the cost to fee-for-service Medicare for each beneficiary in the base year of our analysis, 2016. "Conditions added in 2019" are the HCCs that CMS added to the CMS-HCC model in 2019. "Number of beneficiary years" is the sum across all beneficiaries in our analytic file of the fraction of the prediction year (2017) that each beneficiary was in both Part A and Part B of fee-for-service Medicare.

Source: MedPAC analysis of version of the CMS-HCC model that CMS used to risk adjust MA payments in 2020. Data used in this analysis include all standard analytic claims files for the inpatient, outpatient, and physician sectors in 2016; standard analytic claims for all sectors in 2017; Medicare denominator files for 2016 and 2017; the custom Medicare enrollment file; and Medicare risk adjustment files for 2017.

**TABLE
4-4**

Predictive ratios for CMS-HCC model V24.2, a model created by the Commission for this analysis, which is based on two years of diagnosis data

Beneficiary category	Full Medicaid		Partial Medicaid		No Medicaid		LTI
	Disabled	Aged	Disabled	Aged	Disabled	Aged	
R^2	0.121	0.114	0.076	0.102	0.103	0.119	0.090
Conditions in model V22							
AMI	1.04	1.00	1.01	1.00	1.00	1.00	1.02
Cancer	1.00	1.00	1.01	1.00	1.00	1.00	1.01
CHF	1.01	1.00	1.00	1.00	1.00	1.00	1.01
COPD	1.00	1.00	1.00	1.00	1.00	1.00	1.00
Diabetes	1.01	1.00	0.99	1.01	1.00	1.00	1.00
Mental illness	1.00	1.00	1.00	1.00	1.00	1.00	1.04
Schizophrenia	1.00	0.98	0.99	1.00	1.02	0.99	1.01
Stroke	0.99	0.99	1.01	0.99	1.01	0.99	1.01
Ischemic or unspecified stroke	0.99	0.98	1.00	0.98	0.99	0.99	1.00
Number of conditions (added in model V24.1)							
No conditions	0.87	0.87	0.90	0.92	0.89	0.97	0.81
1 condition	0.96	1.02	1.00	1.03	1.01	1.01	0.99
2 conditions	1.00	1.02	1.01	1.02	1.01	1.01	1.02
3 conditions	1.02	1.01	1.00	1.00	1.03	1.00	1.02
4 conditions	1.01	1.01	1.01	0.99	1.02	1.00	1.02
5 or more conditions	1.01	1.00	1.00	1.00	1.00	1.00	1.00
8 or more conditions	1.01	0.99	1.00	1.00	1.00	1.00	0.99
10 or more conditions	1.04	0.98	1.00	1.00	1.02	0.98	0.99
12 or more conditions	0.99	0.94	0.97	0.94	0.96	0.94	0.97
Percentile of base-year cost							
0 to 20 percentile	1.53	1.04	1.45	1.15	1.82	1.31	0.86
20 to 40 percentile	1.56	1.38	1.54	1.36	1.72	1.35	1.53
40 to 60 percentile	1.29	1.26	1.27	1.21	1.26	1.15	1.36
60 to 80 percentile	1.08	1.09	1.06	1.03	0.99	0.94	1.09
80 to 95 percentile	0.91	0.92	0.90	0.88	0.83	0.86	0.96
95 to 99 percentile	0.75	0.81	0.71	0.78	0.66	0.77	0.89
99 percentile and higher	0.58	0.60	0.53	0.64	0.45	0.61	0.76
Conditions added in 2019 for model V23							
Substance abuse, moderate to severe	1.01	0.97	1.04	0.97	1.02	0.97	1.00
Substance abuse, mild	1.00	0.98	1.00	0.93	1.00	1.01	0.96
Reactive and unspecified psychosis	1.00	0.98	0.99	1.02	1.01	1.02	1.05
Personality disorder	0.98	0.89	0.88	0.91	1.07	0.94	1.03
Chronic kidney disease, Stage 3	1.02	0.99	1.09	1.00	1.02	0.98	1.01
Number of beneficiary years (in thousands)							
	760	692	272	310	724	8,811	272

Note: CMS-HCC (CMS-hierarchical condition category), V (version), LTI (long-term institutionalized), AMI (acute myocardial infarction), CHF (congestive heart failure), COPD (chronic obstructive pulmonary disease). V22, V23, and V24.1 are versions of the CMS-HCC model that CMS used in 2017 and 2018; 2019; and 2020, respectively, and V24.2 is a version of the CMS-HCC model that we created for this report. We define "number of conditions" for each beneficiary as the number of HCCs for that beneficiary. "Base-year cost" is the cost to fee-for-service Medicare for each beneficiary in the base year of our analysis, 2016. "Conditions added in 2019" are the HCCs that CMS added to the CMS-HCC model in 2019. "Number of beneficiary years" is the sum across all beneficiaries in our analytic file of the fraction of the prediction year (2017) that each beneficiary was in both Part A and Part B of fee-for-service Medicare.

Source: MedPAC analysis of versions of the CMS-HCC model that uses two years of diagnosis data to determine beneficiaries' conditions. Data used in this analysis include all standard analytic claims files for the inpatient, outpatient, and physician sectors in 2015 and 2016; standard analytic claims for all sectors in 2017; Medicare denominator files for 2016 and 2017; the custom Medicare enrollment file; and Medicare risk adjustment files for 2017.

national average, then the MA payment for that enrollee is adjusted upward by 20 percent. However, MA plans typically provide more complete coding of their enrollees' conditions than would be recorded on FFS claims. This more complete coding results in MA enrollees having higher risk scores than they would have if they were enrolled in FFS Medicare, which results in overpayments to MA plans.

The difference in “coding intensity” between the MA and FFS programs has been persistent. For example, the Commission found that 35 percent of FFS beneficiaries who had kidney failure recorded on a claim in 2007 did not have kidney failure recorded on a claim in 2008. In contrast, only 29 percent of MA enrollees who had kidney failure recorded in 2007 did not have kidney failure recorded in 2008 (Medicare Payment Advisory Commission 2012). However, if CMS uses two years of diagnosis data from FFS Medicare to estimate the CMS–HCC model, CMS will capture more conditions among the FFS population, and the profile of conditions among the FFS population will more closely match the profile of conditions that would have been recorded for those beneficiaries had they been in the MA program. The Commission has done analysis that indicates that use of two years of diagnosis data would reduce MA risk scores relative to FFS Medicare by 1 percent to 2 percent (Medicare Payment Advisory Commission 2016). The result would be reduced payment errors that occur because of coding differences between the MA and FFS programs.

Use of two years of data would also result in the CMS–HCC model producing more accurate estimates of the cost of having a given condition because two years of diagnosis data would identify more beneficiaries who have that condition. Use of one year of data typically identifies the more severe, higher cost cases for a given condition and misses the less severe, lower cost cases. Use of two years of data identifies more of these lower cost cases, which would produce more accurate representations of the cost of each condition in the CMS–HCC model.

Summary

In this chapter, we have reported how each of the changes to the CMS–HCC model required by the 21st Century Cures Act has affected the predictive accuracy

of the model. Our results indicate that each of the changes improves the predictive accuracy for each of the beneficiary populations that are the focus of the changes:

- Creating separate versions of the model for partial Medicaid beneficiaries and full Medicaid beneficiaries produces accurate predictions of the cost of these beneficiaries.
- Adding indicators for mental health disorders, substance abuse disorders, and chronic kidney disease improves how well the CMS–HCC model predicts the cost of beneficiaries who have these conditions, although adding such indicators may provide additional opportunities for MA plans to increase revenue by coding more intensively.
- Adding measures of the number of conditions for each beneficiary improves how well the CMS–HCC model predicts the cost of beneficiaries who have 10 or more conditions.

We note that all versions of the CMS–HCC model that we evaluated overpredict the costs of beneficiaries with low Medicare costs in the base year and underpredict the costs of beneficiaries with very high Medicare costs in the base year. These prediction errors at the extremes of the distribution of base-year costs could be an issue for future consideration.

We found that using two years of diagnosis data to determine beneficiaries' conditions produces payment adjustments that are about as accurate as using one year of diagnosis data, though it produces larger underpayments for those with high levels of Medicare spending than using one year of diagnosis data. Nevertheless, in our view, the use of two years of diagnosis data would be beneficial for MA risk adjustment because it would decrease the extent of coding differences that persists between the MA and FFS sectors of the Medicare program. The result would reduce payment errors that occur because of coding differences between MA and FFS.

The Commission commends the progress that CMS has made in implementing the changes to the CMS–HCC model mandated by the 21st Century Cures Act. We encourage CMS to continue its work on this issue to complete the requirements by the mandated date of January 1, 2022. ■

Endnotes

- 1 A delay in payment adjustment under a concurrent model could occur for any condition diagnosed, depending on how the entity that operates the risk adjustment model chooses to implement the model. For example, risk adjustment under the Affordable Care Act of 2010 (ACA) uses a concurrent system and does not adjust payments for conditions diagnosed in a given year until the following year. For example, the ACA risk adjustment model would not use conditions diagnosed in 2019 to adjust payments until 2020.
- 2 The R^2 statistics are similar across these seven segments, ranging from 0.080 for PARTIAL_BENEFIT_DISABLED to 0.123 for FULL_BENEFIT_DISABLED. The R^2 did not change much as we evaluated the other versions in this study.
- 3 CMS has determined that the full HCC model has 122 HCCs that represent chronic conditions (Centers for Medicare & Medicaid Services 2018, Centers for Medicare & Medicaid Services 2017). At the same time, V22 of the CMS-HCC model has 79 HCCs, so V22 does not adjust payments for chronic conditions that are in 43 HCCs.

References

Centers for Medicare & Medicaid Services, Department of Health and Human Services. 2018. Advance notice of methodological changes for calendar year (CY) 2019 for Medicare Advantage capitation rates, Part C and Part D payment policies and 2019 draft call letter. February 1. <https://www.cms.gov/medicare/health-plans/medicareadvtspecratestats/downloads/advance2018.pdf>.

Centers for Medicare & Medicaid Services, Department of Health and Human Services. 2017. Advance notice of methodological changes for calendar year (CY) 2019 for the Medicare Advantage (MA) CMS–HCC risk adjustment model. December 27. <https://www.cms.gov/Medicare/Health-Plans/MedicareAdvtspecRateStats/Downloads/Advance2019Part1.pdf>.

Centers for Medicare & Medicaid Services, Department of Health and Human Services. 2003. Announcement of calendar year (CY) 2004 Medicare+Choice payment rates. May 12. <https://www.cms.gov/Medicare/Health-Plans/MedicareAdvtspecRateStats/Downloads/Announcement2004.pdf>.

Kronick, R., and W. P. Welch. 2014. Measuring coding intensity in the Medicare Advantage program. *Medicare & Medicaid Research Review* 4, no. 2.

Medicare Payment Advisory Commission. 2019a. *A data book: Health care spending and the Medicare program*. Washington, DC: MedPAC.

Medicare Payment Advisory Commission. 2019b. *Report to the Congress: Medicare payment policy*. Washington, DC: MedPAC.

Medicare Payment Advisory Commission. 2016. *Report to the Congress: Medicare payment policy*. Washington, DC: MedPAC.

Medicare Payment Advisory Commission. 2012. *Report to the Congress: Medicare and the health care delivery system*. Washington, DC: MedPAC.

Pope, G., R. Ellis, A. Ash, et al. 2000. *Diagnostic cost group hierarchical condition category models for Medicare risk adjustment*. Report prepared for the Health Care Financing Administration. Baltimore, MD: HCFA.

CHAPTER

5

**Realigning incentives
in Medicare Part D**

R E C O M M E N D A T I O N S

5-1 The Congress should make the following changes to the Part D prescription drug benefit:

- Below the out-of-pocket threshold:
 - Eliminate the initial coverage limit.
 - Eliminate the coverage-gap discount program.
- Above the out-of-pocket threshold:
 - Eliminate enrollee cost sharing.
 - Transition Medicare’s reinsurance subsidy from 80 percent to 20 percent.
 - Require pharmaceutical manufacturers to provide a discount equal to no less than 30 percent of the negotiated price for brand drugs, biologics, biosimilars, and high-cost generic drugs.

COMMISSIONER VOTES: YES 16 • NO 0 • NOT VOTING 1 • ABSENT 0

.....
5-2 Concurrent with our recommended changes to the benefit design, the Congress should:

- Establish a higher copayment amount under the low-income subsidy for nonpreferred and nonformulary drugs.
- Give plan sponsors greater flexibility to manage the use of drugs in the protected classes.
- Modify the program’s risk corridors to reduce plans’ aggregate risk during the transition to the new benefit structure.

COMMISSIONER VOTES: YES 16 • NO 0 • NOT VOTING 1 • ABSENT 0

.....
5-3 Concurrent with our recommended changes to the benefit design, the Secretary should:

- Allow plans to establish preferred and nonpreferred tiers for specialty-tier drugs.
- Recalibrate Part D’s risk adjusters to reflect the higher benefit liability that plans bear under the new benefit structure.

COMMISSIONER VOTES: YES 16 • NO 0 • NOT VOTING 1 • ABSENT 0

Realigning incentives in Medicare Part D

Chapter summary

Medicare pays competing private plans to deliver drug benefits to enrolled beneficiaries under Part D. Medicare’s payment system for Part D is different from fee-for-service (FFS) payment systems used under Part A and Part B. For Part D, policymakers envisioned a program that relies on competition among private plan sponsors that bear insurance risk for managing prescription drug use and spending while offering benefit packages that are attractive to enrollees. Instead of setting payments to plans administratively, Medicare’s payments are based on bids submitted by plan sponsors that reflect their average cost (including administrative expenses and an operating margin) of providing a basic outpatient drug benefit to an enrollee of average health.

In the early years of the Part D program, plan sponsors were at risk for a large share of their enrollees’ benefit spending, but that share has declined markedly over time. Between 2007 and 2017, among enrollees without Part D’s low-income subsidy (LIS), the share of basic benefit costs for which plan sponsors were responsible declined from 53 percent to 29 percent. For LIS enrollees, plan liability decreased from 30 percent to 19 percent over the same period. Meanwhile, the Medicare program’s share of benefits reimbursed through two cost-based mechanisms—reinsurance (intended to give plan sponsors some protection against unpredictable variation in costs) and low-income cost-sharing subsidies—rose commensurately. The magnitude of decreases in plans’ share of benefit liability raises significant concerns because it shifts

In this chapter

- Background
- Restructuring Part D to restore incentives to manage spending
- Other modifications to Part D associated with a restructured benefit
- Recommendations for a restructured Part D benefit

substantial financial risk to the Medicare program and taxpayers and undermines a key feature of the Part D program: providing incentives for competing private plans that bear insurance risk for their enrollees' spending to negotiate prices with pharmacies and pharmaceutical manufacturers.

In 2016, the Commission recommended major changes to Part D's benefit structure that would have plan sponsors bear more financial risk for their enrollees' drug spending while, at the same time, providing sponsors with greater flexibility to use formulary tools. The Commission believed that the recommendations would introduce better incentives for plan sponsors to manage drug benefit spending. Since then, changes in law and expanded use of high-priced drugs have further eroded the competitive incentives for cost control and have led the Commission to consider new approaches for restructuring Part D.

Building on the 2016 recommendations, the Commission recommends changes to the Part D program that would restore the role of risk-based, capitated payments that was present at the start of Part D, limit enrollees' out-of-pocket (OOP) spending, and eliminate features of the program that distort market incentives. These reforms will better align the incentives in Part D with the interests of the Medicare program and its beneficiaries. The Commission's package of recommendations would restructure Part D's defined standard benefit as follows:

- For spending below the catastrophic threshold, eliminate the manufacturers' coverage-gap discount that currently applies to enrollees without the LIS and remove the coverage gap for LIS enrollees. These changes would create a standard benefit for all enrollees in which plans would become responsible for 75 percent of spending for benefits between the deductible and the catastrophic threshold, with enrollees responsible for the remaining 25 percent through cost sharing.
- For spending above the catastrophic threshold, reduce Medicare's reinsurance by shifting insurance risk to plan sponsors and drug manufacturers. Medicare would provide 20 percent reinsurance rather than the current 80 percent. Manufacturers would become responsible for at least 30 percent of catastrophic spending on high-priced medicines, while plan sponsors would be liable for the remaining 50 percent. That share is up from the 15 percent of catastrophic benefits that plans cover today. Consistent with our 2016 recommendations, the policy would provide enrollees with greater financial protection by adding an annual cap on beneficiaries' OOP costs.

We recommend that the reduction in Medicare's reinsurance payments and increase in plan liability for catastrophic spending be phased in. (The other elements of

the new benefit structure—eliminating the coverage gap, replacing the coverage-gap discount program with a new discount program in the catastrophic phase, and adding an annual cap on beneficiary OOP costs—would be implemented without a transition.) A longer transition would give plans more time to adjust to the new benefit structure and distribution of risk and allow policymakers to respond to any unexpected outcomes before the new structure is fully phased in. However, it would also leave some of the current system’s misaligned incentives in place longer and potentially inhibit the entrance into the market of new Part D sponsors.

Under the new benefit structure, sponsors would incorporate lower expected Medicare reinsurance subsidies and higher expected benefit liability into plan bids. In turn, Medicare’s capitated payments to plans would increase to incorporate their new, higher share of spending below and above the catastrophic threshold. CMS would also apply risk adjusters to reflect predictable differences in average spending among enrollees based on factors such as age category, disability status, LIS status, and diagnoses.

We recommend a new manufacturers’ discount of at least 30 percent in the catastrophic phase of the benefit. The discount would be more likely to apply to drugs and biologics that command high prices, which could act as a drag on price growth. The discount would apply to LIS beneficiaries as well as to enrollees without the LIS. In addition, the discount could be structured so that if the average price of drugs that were subject to the discount increased faster than a benchmark (such as average Part D spending), the discount rate would increase commensurately.

To help plan sponsors manage overall drug spending more effectively, we recommend that the Congress establish a higher copayment amount under the LIS for nonpreferred and nonformulary drugs. Current LIS copayments provide much weaker financial incentives to choose lower cost medications than those faced by other enrollees. In addition, we recommend that plan sponsors be provided with greater formulary flexibility for drugs in the protected classes. Currently, plan sponsors’ inability to exclude products from a plan’s formulary limits sponsors from using competitive pressure among alternative drug therapies to negotiate manufacturer rebates. We also recommend that plans be allowed to establish preferred and nonpreferred tiers for specialty-tier drugs to encourage their enrollees to use lower priced therapies.

It will be critically important for CMS to recalibrate Part D’s risk adjustment model to reflect the increased plan liability. The Commission’s recommended reforms would result in higher capitated payments for all enrollees, with a larger impact,

in dollar terms, for LIS beneficiaries. Given the structure of the risk adjustment model, we believe that CMS will be able to recalibrate the model to ensure that overall payment rates are adequate for both LIS enrollees and other Part D beneficiaries. Nevertheless, one concern is that because risk adjustment models tend to underpredict very high spending and overpredict very low spending, plans that enroll a relatively large share of high-cost beneficiaries could be disadvantaged. Of particular concern to the Commission are smaller plan sponsors that enroll a high share of LIS beneficiaries.

To examine whether plan sponsors with high shares of LIS beneficiaries are likely to be disadvantaged as a result of inadequate risk adjustment, we compared variation in Part D's gross drug spending for LIS and other Part D beneficiaries. Our findings suggest that, because spending for LIS beneficiaries has relatively less variation than spending for beneficiaries without the LIS, CMS's risk-adjusted payments are less likely to systematically underestimate actual spending for LIS enrollees with very high costs than for other high-cost enrollees. We also separately examined variation in catastrophic spending, which is less easily predicted than spending in the lower phases of the benefit because the extreme values are influenced more heavily by use of high-priced drug and biologic treatments for less-prevalent conditions, such as cancer and rheumatoid arthritis. We found that relative variation around the average was more than twice as large for beneficiaries without the LIS compared with LIS beneficiaries. This difference suggests a recalibrated risk adjustment model would be more likely to underpredict very high spending incurred by beneficiaries without the LIS than it would for beneficiaries with the LIS.

Given plans' greater insurance risk associated with catastrophic spending under these reforms, policymakers could consider modifying the Part D risk corridors to temporarily provide plan sponsors with greater protection during a transition to the new benefit structure. For example, the risk corridors could be narrowed so that plans were fully at risk for less than 5 percent of their aggregate expected benefit costs. Policymakers could also consider different risk-sharing percentages in the corridors, potentially increasing plans' aggregate stop-loss protection (i.e., reducing plans' insurance risk above a threshold). While the enhanced protection would be available to all plans, in practice, the protection would be particularly valuable for smaller plans and plan sponsors that do not have the scale to spread the insurance risk or the capital to reinsure themselves. ■

Background

In 2016, the Commission recommended major changes to the structure of Medicare’s Part D prescription drug benefit to address the misaligned incentives as reflected in patterns of Medicare payments to private plans and plans’ bidding behavior. Those recommendations would have had plan sponsors bear more financial risk for their enrollees’ drug spending while, at the same time, providing sponsors with greater flexibility to use formulary tools (Medicare Payment Advisory Commission 2016).

Since then, changes in law and greater spending for high-priced drugs have led the Commission to consider new approaches for restructuring Part D (Medicare Payment Advisory Commission 2019d). The reforms we recommend in this chapter build on the 2016 package of recommendations, but with two major changes. First, for spending below the catastrophic threshold, we recommend eliminating the manufacturers’ coverage-gap discount that currently applies to enrollees without the low-income subsidy (LIS) and removing the coverage gap for LIS enrollees. These changes would create a standard benefit for all enrollees in which plans would become responsible for 75 percent of benefits between the deductible and the catastrophic threshold, with enrollees responsible for the remaining 25 percent through cost sharing. Second, for spending above the catastrophic threshold, we recommend shifting insurance risk from Medicare to plan sponsors and drug manufacturers. Medicare would provide 20 percent reinsurance rather than the current 80 percent. Manufacturers would become newly responsible for 30 percent or more of catastrophic spending on high-priced medicines, while plan sponsors would be liable for the remaining 50 percent, up from the 15 percent of catastrophic spending they cover today. Consistent with our 2016 recommendations, we also recommend providing enrollees with greater financial protection by adding an annual cap on beneficiaries’ out-of-pocket (OOP) costs.

This chapter also provides an overview of ways in which the program could give plan sponsors greater flexibility to manage formularies, as well as how Part D’s mechanisms for sharing risk might be modified during the transition to a restructured benefit.

Misaligned incentives under Medicare’s payment system for Part D

Medicare’s payment system for Part D is different from fee-for-service (FFS) payment systems used under Part A

and Part B. For Part D, policymakers envisioned a program that relies on competition among private plan sponsors that bear insurance risk for managing prescription drug use and spending while offering benefit packages that are attractive to enrollees. Part D subsidizes basic drug benefits whether a beneficiary is in FFS Medicare and enrolls in a stand-alone prescription drug plan (PDP) or in Medicare Advantage (MA) and enrolls in an MA–Prescription Drug [plan] (MA–PD). Instead of setting payments to plans administratively, Medicare’s payments are based on bids submitted by plan sponsors that reflect their average cost (including administrative expenses and an operating margin) of providing a basic outpatient drug benefit to an enrollee of average health (Medicare Payment Advisory Commission 2019c). Part D includes risk corridors that limit each plan’s overall losses or profits if a plan’s benefit spending is substantially higher or lower than amounts anticipated in the plan’s bid. If plan sponsors are successful at keeping benefit costs below what they bid, they retain most of the difference between payments and actual benefit costs as additional profits. The philosophical foundation of using competing private plans in Part D is reflected in the law’s “noninterference” provision, which explicitly prohibits the Health and Human Services Secretary from “interfer[ing] with the negotiations between drug manufacturers and pharmacies and PDP sponsors.” The law also prohibits the Secretary from “requir[ing] a particular formulary or institut[ing] a price structure for the reimbursement of covered Part D drugs.” (See text box on the Commission’s approach to date with respect to Part D reforms, p. 124.)

Medicare law defines a standard Part D benefit that, for 2020, includes a \$435 deductible and 25 percent coinsurance until the enrollee reaches an OOP threshold (at roughly \$9,000 to \$10,000 in gross drug spending).¹ Above this threshold, enrollees generally pay 5 percent coinsurance with no upper limit on their annual cost-sharing liability. Most plan sponsors structure their basic benefits in ways that differ from the defined standard benefit, but sponsors must demonstrate that those alternative benefit structures have the same average value as the defined standard benefit. Medicare provides two types of subsidies to plans on behalf of all Part D enrollees: (1) monthly capitated payments adjusted for risk and (2) individual reinsurance equal to 80 percent of prescription costs above the OOP threshold (net of postsale rebates). Medicare’s subsidies aim to cover 74.5 percent of the cost of basic benefits, with enrollee

The Commission's approach to Part D reform

Policy makers structured the Part D program using private plans that compete to attract enrollees based on the prescription drugs they cover, pharmacy networks, premiums, cost sharing, and quality of services. Plan sponsors negotiate with pharmacies over reimbursement rates for prescriptions filled by their enrollees, as well as with pharmaceutical manufacturers for postsale rebates. Under current Part D law, the federal government may not interfere in those private negotiations, establish a specific formulary, or set prices for drugs.

To date, the Commission has not recommended measures that would require altering this basic approach. In keeping with the program's original philosophy, the Commission's 2016 recommendations would modify the benefit design and structure of Medicare subsidies to strengthen the incentives of

private entities involved in negotiating drug prices (Medicare Payment Advisory Commission 2016). Similarly, our recommendations in this chapter aim to restore the role of risk-based, capitated payments that was present at the start of Part D and eliminate features of the program that distort market incentives.

Nevertheless, the Commission intends to continue monitoring growth in drug prices and monitoring the implications of that growth for beneficiaries' access to biopharmaceutical therapies and for taxpayers. The premise behind Part D's competitive approach is that plan sponsors can negotiate for lower prices because manufacturers are offering competing drug therapies. In therapeutic classes where such competition is weak or does not exist, private plans have little or no bargaining leverage with manufacturers for price reductions. Other policy approaches may be needed to address those circumstances. ■

premiums covering the remaining 25.5 percent. Premiums for plans vary individually, however, depending on how high or low their sponsor bids and whether they offer supplemental coverage (which Medicare does not subsidize).

The Part D benefit also includes the LIS to ensure that poorer beneficiaries have sufficient access to drug coverage. Beneficiaries qualify for the LIS if they are eligible for any type of Medicaid benefits or have income below 150 percent of the federal poverty guideline and limited assets.² In 2019, 28 percent of Part D enrollees received the LIS, most of whom were Medicare–Medicaid dual-eligible beneficiaries. Part D's LIS has two components: premium subsidies and cost-sharing subsidies. The low-income cost-sharing subsidy (LICS) makes up more than 85 percent of combined LIS spending. CMS makes monthly prospective payments to plans for both LIS premium subsidies and the LICS. Payments for the latter are based on plan estimates and are later reconciled to actual costs after the end of each plan year.

In keeping with Part D's market-based approach, in the early years of the program, plan sponsors were at risk for a large share of their enrollees' benefit spending. However, over the past decade, the share of benefit costs borne by plan sponsors has declined markedly. Figure 5-1 displays estimates of Part D spending, net of rebates, for basic benefits for enrollees with and without the LIS. The estimates reflect spending amounts on Part D claims minus average rebates as reported by the Medicare Trustees (Boards of Trustees 2019). Between 2007 and 2017, among enrollees without the LIS, the share of basic benefit costs for which plan sponsors were responsible declined from 53 percent to 29 percent. For LIS enrollees, plan liability decreased from 30 percent to 19 percent over the same period. Meanwhile, the Medicare program's share of benefits reimbursed through two cost-based mechanisms—reinsurance and LICS—rose commensurately. The magnitude of decreases in plans' share of benefit liability raises significant concerns because it undermines key features of the Part D program: competing private entities that bear financial risk for their enrollees' spending.

FIGURE 5-1

Plans' share of benefit liability declined markedly between 2007 and 2017

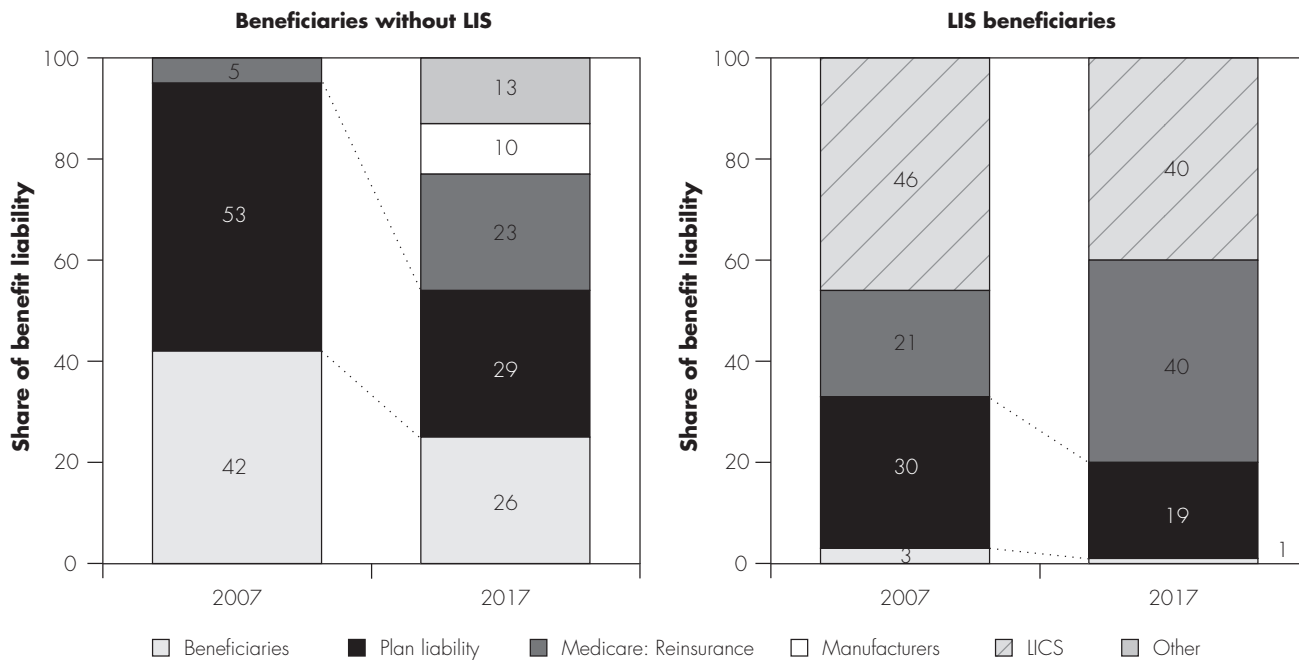

Note: LIS (low-income subsidy), LICS (low-income cost-sharing subsidy). Estimated spending net of all rebates and discounts. Figures assume that the percentage reduction in total spending attributable to rebates and discounts does not differ systematically between beneficiaries with the LIS and those without the LIS. Components may not sum to 100 percent due to rounding. The “other” figures include payments by patient assistance organizations and third-party payers, other than Part D plans, that reduce beneficiary cost-sharing liability (such as employers who provide supplemental coverage to retirees).

Source: MedPAC based on Part D prescription drug event data and aggregate direct and indirect remunerations from the Medicare Trustees (Boards of Trustees 2019).

Low plan liability and expanded use of high-cost medicines have eroded incentives to manage spending

Changes in Part D law that financed the phase-out of the coverage gap through brand manufacturer discounts and the expanded use of high-cost medicines have reduced plans' liability for benefit spending, thereby eroding plans' incentives to manage spending.

Changes to Part D's coverage gap

Part D's defined standard benefit covers 75 percent of drug spending above the deductible and all but 5 percent coinsurance once an enrollee reaches the OOP threshold (Figure 5-2, p. 126). That threshold is based on “true OOP” costs because it excludes beneficiary cost sharing paid by most sources of supplemental coverage, such as employer-sponsored policies and enhanced benefits. For

LIS enrollees, Medicare's LICS pays for the difference between the cost-sharing amounts in the plan's formulary and nominal copayments set by law (Figure 5-2).

Before 2011, enrollees who did not receive the LIS and had spending that exceeded an initial coverage limit were responsible for paying each subsequent prescription's full price at the pharmacy (i.e., 100 percent cost sharing) until they reached the OOP threshold. This is known as the coverage gap. Even today, when the defined standard benefit has 25 percent coinsurance in both the initial coverage phase and coverage-gap phase, many Part D plans structure their cost sharing differently across the two phases, with copayments for generics and preferred drugs initially, but 25 percent coinsurance in the coverage gap. For LIS enrollees, Part D's LICS pays for all coverage-gap spending other than nominal copayments set by law.

FIGURE 5-2

Part D has two distinct benefit structures for enrollees with and without the LIS

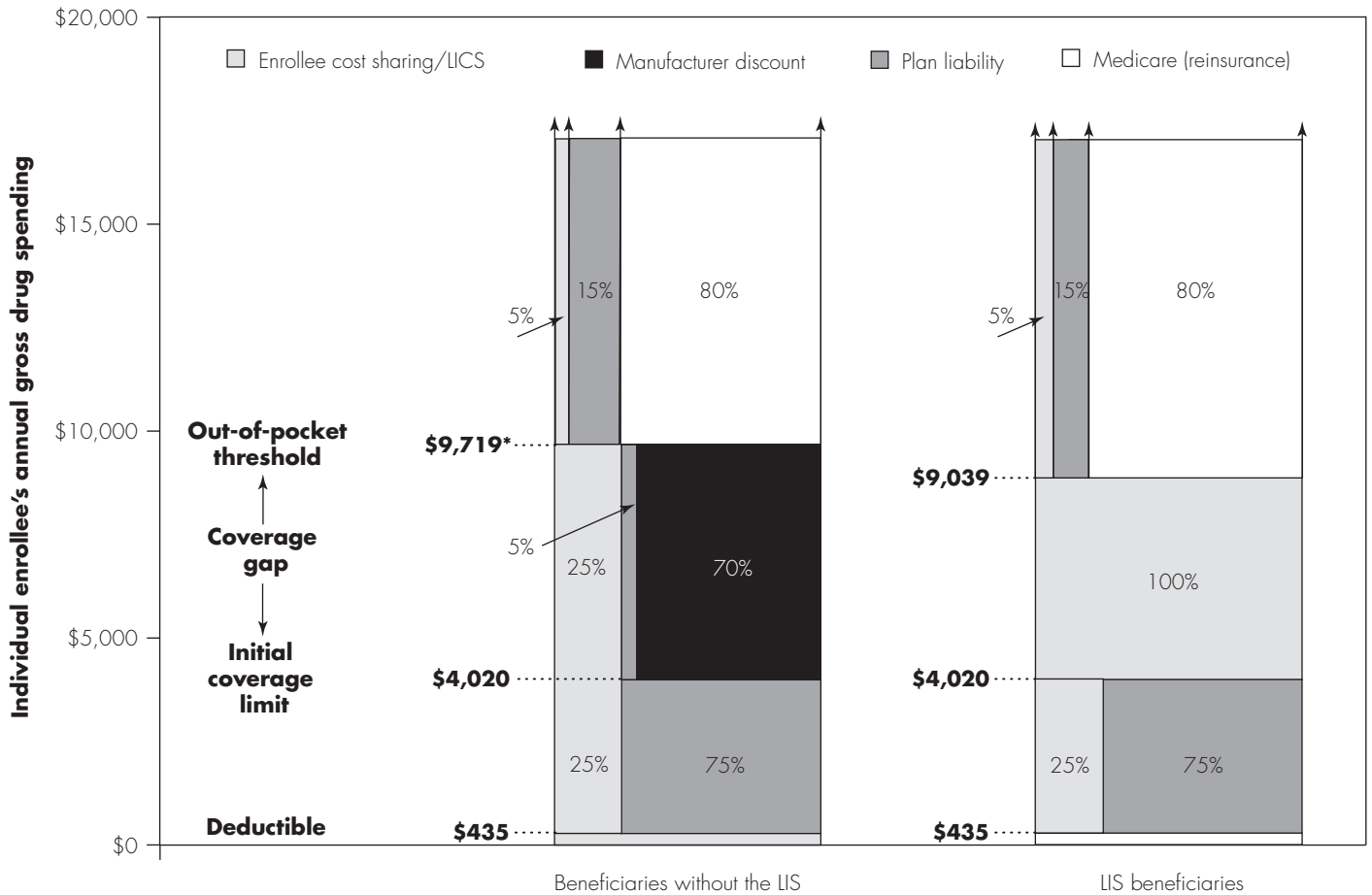

Note: LIS (low-income subsidy), LICS (low-income cost-sharing subsidy). For beneficiaries without the LIS (left bar), the coverage gap (between the initial coverage limit and the out-of-pocket (OOP) threshold) is depicted as it would apply to brand-name drugs. Plan sponsors pay 75 percent of the cost of generic prescriptions filled in the coverage-gap phase for beneficiaries without the LIS. For LIS beneficiaries, Medicare’s low-income cost-sharing subsidy pays for all spending in the coverage gap except LIS enrollees’ nominal copayments. In 2018, the total amount of cost sharing paid directly OOP by LIS beneficiaries accounted for about 1 percent of total gross spending.

*Total covered drug spending at the annual OOP threshold for beneficiaries who do not receive the LIS depends on the mix of brand and generic drugs filled in the coverage gap. The dollar amount shown (\$9,719) was estimated by CMS for an individual with an average mix of drugs who does not receive Part D’s LIS and has no other supplemental coverage.

Source: MedPAC depiction of Part D benefit structure for 2020 as set by law.

Manufacturer discounts in the coverage gap distort market incentives The Affordable Care Act of 2010 (ACA) and the Bipartisan Budget Act (BBA) of 2018 expanded Part D’s defined standard benefit to gradually eliminate the coverage gap for enrollees without the LIS. As shown in Figure 5-2, this expansion left two distinct benefit structures in Part D: one for enrollees without the LIS and one for enrollees with the LIS. Much of this benefit expansion was financed by requiring brand-name

drug manufacturers to discount prices in the coverage gap. While the phase-out of the coverage gap lowered OOP costs for some beneficiaries, the manufacturer discount artificially lowered the price of brand-name drugs relative to generics, reducing incentives to use generics.

Those incentives are further undermined because the 70 percent manufacturer coverage-gap discount on brand-name drugs is treated as though it were the enrollee’s own spending. Thus, enrollees without the LIS reach

Part D's catastrophic phase more quickly when they use brand-name drugs than when they use generic drugs. Manufacturers of brand-name drugs benefit when enrollees reach the catastrophic phase because they are no longer required to discount prices.

Plan sponsors must cover 75 percent of generic spending but just 5 percent of brand spending in the coverage gap while also receiving postsale rebates and discounts on some brand prescriptions. Sponsors cover 15 percent of all spending (generic or brand) in the catastrophic phase. CMS's Office of the Actuary projects that, in 2020, plan sponsors will obtain postsale rebates and discounts worth about 28 percent of total drug costs (Boards of Trustees 2019). For some brand-name drugs, the value of rebates and discounts can exceed plan liability in both the coverage-gap and catastrophic phases of the benefit. For some products, plan sponsors may find that including a brand-name drug on their formulary rather than a generic or giving the brand preferred status lowers their plan liability. However, those formulary placement decisions also increase costs for enrollees and Medicare (Dusetzina et al. 2019). CMS raised concern about the effects of the coverage-gap discount and low plan liability in two recent call letters to plan sponsors (Centers for Medicare & Medicaid Services 2019a, Centers for Medicare & Medicaid Services 2018a).

Benefit design for LIS enrollees creates little incentive for cost control For LIS enrollees, the ACA retained Part D's original defined standard benefit structure, with no plan liability in the coverage-gap phase and no brand discount from manufacturers. Instead, coverage-gap costs are borne almost entirely by the Medicare program. Part D's LICS reimburses plan sponsors for the difference between 100 percent cost sharing and LIS enrollees' nominal copayments. Because 100 percent of the costs in the coverage gap count toward the OOP threshold, LIS beneficiaries reach the catastrophic phase of the benefit at a lower level of spending than other enrollees do.

The LIS benefit structure shares a common feature with the benefit design for other enrollees in that plan sponsors bear little or no liability for spending in the coverage-gap phase. For LIS enrollees, plans bear zero benefit liability, yet sponsors receive postsale rebates on some brand-name prescriptions. That means brand prescriptions filled by LIS enrollees in the coverage gap can be profitable for plan sponsors, undermining incentives for cost control. At the same time, because Medicare's LICS covers most

cost sharing, LIS beneficiaries have little incentive to use lower cost drugs. These features may be reasons why LIS enrollees use more brand-name drugs even when generic alternatives are available.

Expanded role of high-priced drugs drives growth in reinsurance

Part D's distribution of drug spending has changed dramatically since the start of the program in 2006. Early on, the vast majority of spending was attributable to prescriptions for widely prevalent conditions such as high cholesterol, diabetes, and hypertension (Medicare Payment Advisory Commission 2010). Most prescription spending was for small-molecule brand-name drugs that competed with other therapies based on clinical effectiveness and price.

Beginning around 2010, a number of blockbuster treatments began to lose patent protection, and many Part D enrollees switched to generic versions of their medicines (Medicare Payment Advisory Commission 2017). As revenues for small-molecule brand-name drugs fell, manufacturers turned to developing orphan drugs, biologics, and other specialty drugs that treat smaller patient populations for conditions such as rheumatoid arthritis, hepatitis C, and cancer. Those medicines are often launched at very high prices, with annual costs per person sometimes reaching tens of thousands of dollars or more. List prices for many existing brand-name therapies increased at a rapid pace as well.

By law, CMS increases Part D's OOP threshold annually at the same rate as the annual change in enrollees' average drug expenses. Between 2006 and 2018, increased generic use helped to keep growth in average Part D drug expenses to about 4 percent per year (Medicare Payment Advisory Commission 2019e). However, prices of brand-name drugs and biologics grew at a much faster rate over the same period—more than 7 percent annually.³ As a result, an increasing share of spending for high-priced, brand-name products is in Part D's catastrophic phase, where Medicare pays 80 percent of the costs through reinsurance and plans bear just 15 percent benefit liability.

Before 2010, less than 20 percent of spending was for prescriptions filled in the catastrophic phase of the Part D benefit. Since 2010, catastrophic spending has more than quadrupled. As a result, catastrophic spending's share of total spending increased from 20 percent in 2010 to 41 percent in 2018 (Figure 5-3, p. 128).

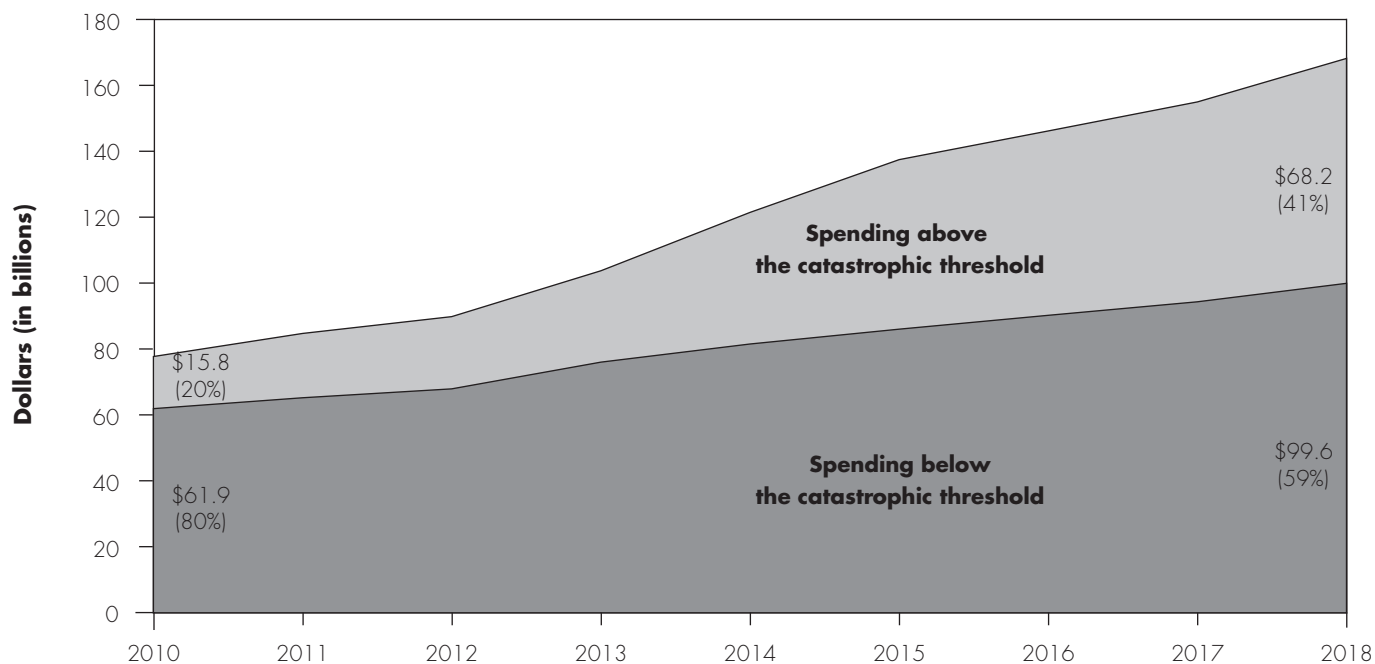
**FIGURE
5-3****The proportion of gross Part D spending made up by catastrophic benefits more than doubled, 2010-2018**

Note: Catastrophic benefits are defined as enrollee spending above Part D's out-of-pocket threshold. "Gross Part D spending" refers to amounts paid at the pharmacy before postsale rebates and discounts.

Source: MedPAC analysis of Part D prescription drug event data.

Higher prices, reflecting both increases in prices of existing products and the use of new high-priced drugs, are the primary driver of the rapid growth in catastrophic spending. Between 2010 and 2017, the average price per standardized, 30-day prescription filled by beneficiaries who reached the catastrophic phase grew by 9.4 percent per year, while the number of prescriptions filled per enrollee remained flat. This growth rate is in stark contrast to enrollees who did not reach the catastrophic phase: Their average price per prescription fell by an annual rate of 2.9 percent, while the number of prescriptions filled per enrollee grew by 1.3 percent per year.

Part D's benefit design contributes to the inflationary trend in drug prices

While Medicare's influence on drug pricing is indirect, the program accounts for about one-third of U.S. retail pharmaceutical sales (Hartman et al. 2019). As a result,

Medicare's payment policies can have a significant financial effect on drug manufacturers. High drug prices are not unique to Part D. However, for medications that are more likely to be used by Medicare beneficiaries, the Commission has been concerned that the program's orientation toward premium competition and Part D's unique benefit design may contribute to higher prices (Medicare Payment Advisory Commission 2017).

One concern is that Part D plan sponsors' focus on rebates has been inflationary. In drug classes that have competing therapies, plan sponsors negotiate with brand manufacturers for rebates that are paid after a prescription has been filled. Generally, manufacturers pay larger rebates when a plan sponsor positions a drug on its formulary in ways that increase the likelihood that the manufacturer will win market share over competitors. Rebates are often calculated as a percentage of a drug's

list price, and thus higher prices can lead to a higher dollar amount of rebates. Moreover, when plan sponsors negotiate a “price protection” provision, rebates are linked directly to manufacturers’ price increases (Kaczmarek 2015, Pharmacy Benefit Management Institute 2017). Sponsors may be less resistant to manufacturers’ price increases for brand medications when there are rebates to offset some or all the plan’s benefit liability.

In many situations, plan sponsors focus on rebates to keep their premiums competitive; they generally use rebate revenues to offset aggregate benefit costs and thereby lower their premiums. Using rebates to offset the cost of aggregate benefits may also increase the likelihood of retaining profits in Part D’s risk corridors (Walker and Weaver 2019). However, beneficiaries pay coinsurance based on point-of-sale (POS) prices—those prices at the pharmacy counter before postsale rebates and discounts. In turn, beneficiaries reach Part D’s OOP threshold more quickly than if coinsurance were charged on net prices. Similarly, the Medicare program pays more in reinsurance and LICS than it would if there were a smaller difference between POS and net prices (Centers for Medicare & Medicaid Services 2017).

Part D’s unique structure can also contribute to inflationary trends in drug prices. Part D’s benefit design can create incentives to include high-cost, high-rebate drugs on formularies over other drugs because plan sponsors bear relatively little liability for benefit spending in the coverage gap and catastrophic phase (Fein 2020). At the same time, manufacturers may find that, for some products, higher prices allow them to offer larger rebates than their competitors and gain more market share through favorable formulary placement.

In addition, because coverage-gap discounts apply to a limited range of spending (between the initial coverage limit and the OOP threshold), a manufacturer’s liability for any given beneficiary is capped. In 2020, the maximum amount any brand manufacturer would pay is about \$4,000 per beneficiary regardless of the price it charges for its product. As a result, if a manufacturer can raise the prices of its products, that increase could offset some or all of the costs associated with the coverage-gap discounts.

Policymakers’ decisions about the amount that manufacturers must pay in coverage-gap discounts may have factored into manufacturers’ decisions about price increases or launch prices, especially for drugs that have

relatively low prices because coverage-gap discounts affect a proportionately larger share of manufacturers’ revenues. For drugs and biologics with prices near or above the catastrophic threshold, manufacturer discounts in the coverage gap are small compared with their revenue from Part D prescriptions (Table 5-1, p. 130). For example, based on 2018 data, gross spending (before postsale rebates and discounts) for Revlimid[®], a chemotherapy drug used for certain cancers, totaled \$4.1 billion. The coverage-gap discount paid by Revlimid’s manufacturer totaled about \$77 million, or 1.9 percent of gross spending. Because the majority (86 percent) of spending for Revlimid occurred in the catastrophic phase of the benefit (above the OOP threshold), the coverage-gap discount applied to the less than 4 percent of spending that fell in the coverage gap. In comparison, about 75 percent of spending for Lantus Solostar[®] (a type of insulin) occurred below the OOP threshold. The coverage-gap discount for Lantus Solostar totaled \$203 million in 2018, or 8.6 percent of the \$2.4 billion in gross spending for this product.

Restructuring Part D to restore incentives to manage spending

In its June 2019 report, the Commission discussed changes to Part D that would simplify the benefit for all enrollees and restore incentives for plans to manage drug spending (Medicare Payment Advisory Commission 2019d). Below the OOP threshold, the new standard benefit would have no coverage gap, making plans responsible for 75 percent of spending between the deductible and the start of the catastrophic phase for all enrollees (Figure 5-4, p. 131). To carry out this change, Part D would eliminate the coverage-gap discount program for enrollees without the LIS and eliminate the coverage gap for LIS enrollees. Above the OOP threshold, consistent with our 2016 recommendations, the policy would provide enrollees with greater financial protection by adding an annual cap on OOP spending. The policy would also phase in a shift of insurance risk from Medicare to plan sponsors and drug manufacturers.

Under the redesigned Part D benefit, Medicare would make larger capitated payments to plan sponsors, with the overall subsidy rate remaining unchanged at 74.5 percent. That is, Medicare’s total payments to plans for the basic benefit would remain unchanged if there were

**TABLE
5-1**

The coverage-gap discount affected a smaller share of spending for higher priced drugs and biologics, 2018

Brand name	Therapeutic class	Total gross spending (in billions)	Coverage-gap discount		Average gross spending per prescription	Share of gross spending above OOP threshold
			Amount (in millions)	As share of total gross spending		
Examples of higher priced drugs and biologics						
Revlimid®	Antineoplastic	\$4.1	\$77	1.9%	\$14,217	86%
Harvoni®	Antiviral	1.7	17	1.0	31,673	89
Humira pen®	Analgesics, anti-inflammatory	2.4	57	2.4	6,053	78
Copaxone®	Multiple sclerosis agent	1.2	28	2.3	6,524	83
Examples of other drugs and biologics						
Lantus Solostar®	Diabetic therapy	\$2.4	203	8.6%	\$530	25%
Eliquis®	Anticoagulant	5.0	541	10.8	549	10
Advair Diskus®	Respiratory therapy agent	2.4	159	6.6	544	16
Lyrica®	CNS agent	3.0	188	6.4	565	28

Note: OOP (out-of-pocket), CNS (central nervous system). "Gross spending" refers to amounts paid at the pharmacy before postsale rebates and discounts.

Source: MedPAC analysis of 2018 Part D prescription drug event data.

no behavioral responses by plan sponsors, manufacturers, or beneficiaries. In practice, because plan sponsors would be liable for a greater share of spending both above and below the OOP threshold, the policy would likely change plan sponsors' formulary incentives and their negotiations with manufacturers over rebates. For example, we anticipate that it would be difficult for manufacturers of high-priced products to offer rebates large enough to make their products financially advantageous for plan sponsors when lower cost products are available. As a result, plan sponsors would likely prefer lower priced products among therapeutic alternatives rather than high-priced, high-rebate products. That change, in turn, would reduce the financial benefit of higher prices for some manufacturers. Collectively, our reforms eliminating the coverage gap and restructuring Part D's catastrophic benefit would involve several policy changes.

Eliminate the coverage gap

The policy to eliminate the coverage gap would discontinue manufacturer discounts below Part D's catastrophic threshold and establish a single defined standard benefit structure for all enrollees.

Discontinue brand manufacturer discounts below the catastrophic phase

Discontinuing brand manufacturer discounts below the catastrophic phase would simplify Part D's benefit structure by making plans responsible for a consistent 75 percent of benefits between the deductible and the OOP threshold. Under this change, the price of brand-name drugs would no longer be artificially lowered relative to generics. Plans would have much less incentive to place high-priced, highly rebated drugs on their formularies, while enrollees without the LIS would face stronger incentives to use lower cost products, potentially reducing Part D costs over the longer term.

Absent other changes, removing the coverage-gap discount would increase benefit costs. For example, in 2018, brand discounts totaled nearly \$7 billion which, under a restructured benefit, plans would have paid instead of manufacturers. (If the coverage-gap discount rate had been 70 percent in 2018 as it was in 2019 and subsequent years, we estimate that the discount amount would have been over \$9 billion.) Under the restructuring of Part D's catastrophic benefit, new manufacturer discounts in

FIGURE 5-4

The Commission’s recommended Part D reforms would simplify Part D’s benefit structure and give plans stronger incentives to manage drug spending

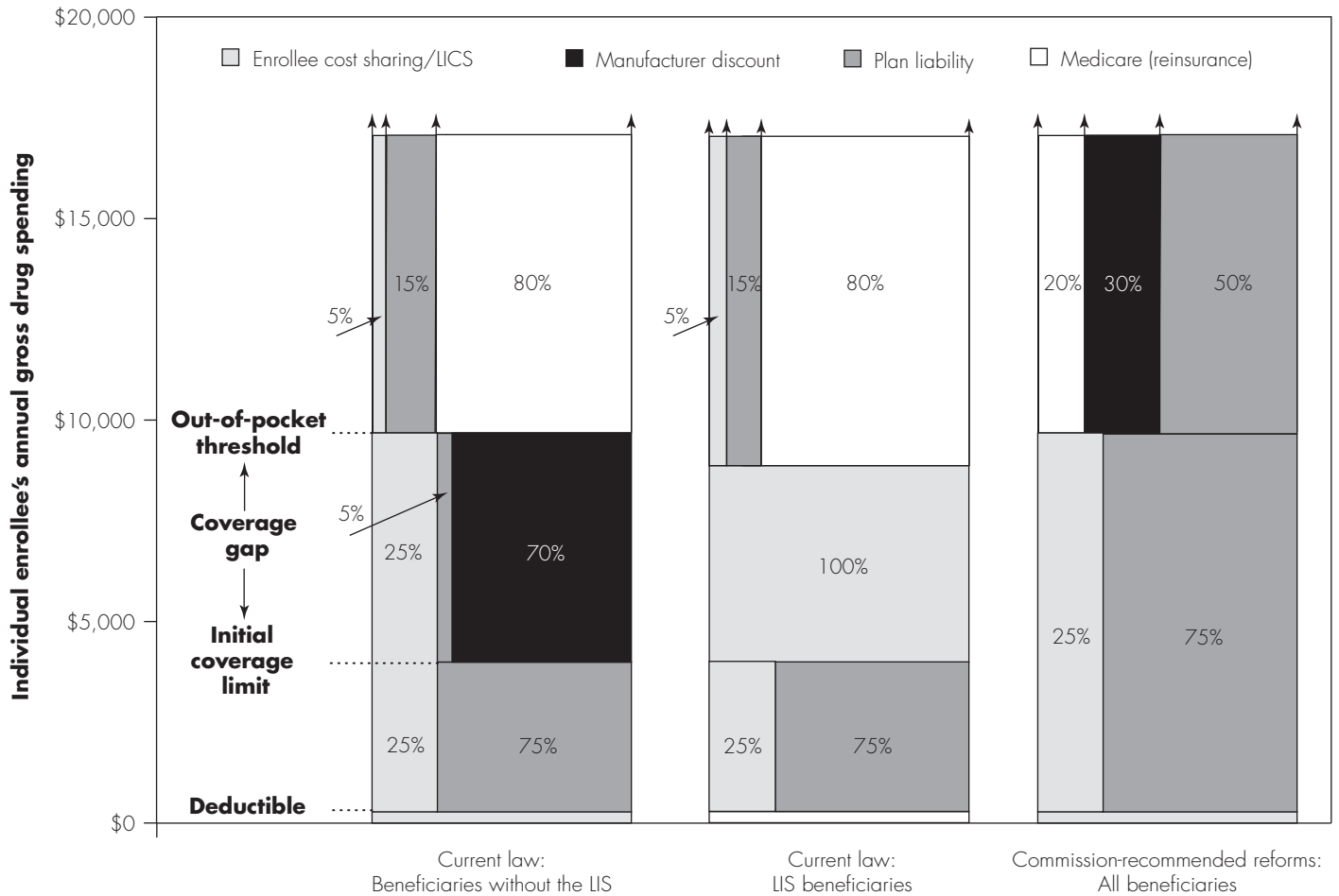

Note: LICS (low-income cost-sharing subsidy), LIS (low-income subsidy). The coverage gap for enrollees without the LIS (between the initial coverage limit and spending at the out-of-pocket (OOP) threshold) is depicted as it would apply to brand-name drugs. For generic prescriptions filled by enrollees without the LIS, cost sharing in the coverage gap is 25 percent and plans are responsible for 75 percent. For LIS enrollees, Medicare’s low-income cost-sharing subsidy pays for all spending in the coverage gap except LIS enrollees’ nominal copayments.

Source: MedPAC depiction of Part D’s benefit structure under current law and under the Commission’s recommended reforms.

the catastrophic phase could replace the coverage-gap discount and thereby offset increased benefit costs.

Plans become responsible for LIS enrollees’ coverage-gap spending

By eliminating the coverage gap for LIS beneficiaries, plans would become responsible for 75 percent of LIS enrollees’ spending between the deductible and the OOP threshold. Because cost sharing for LIS enrollees is limited

to nominal copayments, Medicare’s LICS would cover most or all of the 25 percent cost sharing that enrollees without the LIS pay themselves. The policy change would improve plan sponsors’ formulary and cost-control incentives. However, because much of what is currently covered by the LICS would become part of the basic benefit design, absent other changes, the new approach would also lead to higher costs for the basic benefit and higher premiums for all Part D enrollees.

**TABLE
5-2****Financial impact of eliminating the coverage gap for LIS enrollees, 2018**

	Financial impact (in billions)
Total low-income cost-sharing subsidy in the coverage gap in 2018	\$13.0
New plan liability under a consistent benefit structure for enrollees with and without LIS (roughly 75% of the \$13 billion)	\$10.0
Medicare's payments to plans (74.5%)	\$7.5
Enrollee premiums (25.5%)	\$2.6
Total	\$10.0
Effects on Medicare program spending	
Increase in payments to plans for higher benefit costs	\$7.5
Increase in payments for low-income premium subsidy	\$0.8
Reduction in payments for low-income cost-sharing subsidy	-\$10.0
Net effect	-\$1.8

Note: LIS (low-income subsidy). Components may not sum to totals because of rounding. The low-income cost-sharing subsidy is one component of LIS spending that pays for the difference between the amount of cost sharing charged by a plan and the LIS copayment amount set by law. The other component of LIS spending is the low-income premium subsidy—Medicare payments that cover most or all of the premium (up to a dollar limit that varies by region) on behalf of LIS enrollees.

Source: MedPAC estimate based on Part D prescription drug event data.

To evaluate the effects of this change, we started with an estimate of LIS spending for prescriptions filled in the coverage gap—about \$13 billion in 2018.⁴ Under a revised benefit structure, the basic Part D benefit would cover 75 percent, or about \$10 billion, of LIS enrollees' spending in the coverage gap as currently defined (Table 5-2). Of that \$10 billion, Medicare's subsidy payments to plans for all Part D enrollees would increase by about \$7.5 billion and the remaining \$2.6 billion would be paid in the form of higher enrollee premiums, which would increase by an average of about \$4.80 per month. However, other elements of a restructured benefit, such as the manufacturer discount in the catastrophic phase, could offset some of this premium increase. Of the \$2.6 billion in enrollee premiums, \$0.8 billion would be paid by Medicare for Part D's LIS enrollees, with the remaining \$1.8 billion borne by Part D enrollees without the LIS. Assuming no behavioral changes, the financial impact for Medicare in this example would be the net effect of higher payments to plans for the basic Part D benefit (\$7.5 billion) and higher LIS spending on premiums (\$0.8 billion), offset by \$10 billion in lower LIS spending. Combined, there would be a net reduction in Medicare program spending of \$1.8 billion.

Restructure Part D's catastrophic benefit

The Commission's recommendations to restructure the catastrophic benefit would eliminate beneficiary cost sharing in the catastrophic phase (thereby creating an annual cap on OOP costs) and lower Medicare's reinsurance in favor of manufacturer discounts and greater plan liability.

Eliminate beneficiary cost sharing in the catastrophic phase

In 2018, 3.9 million, or 8.3 percent, of Part D enrollees reached Part D's OOP threshold. Among those individuals, 2.7 million (70 percent) received the LIS and 1.1 million did not (Table 5-3). LIS enrollees are much more likely than other enrollees to reach the catastrophic phase of the benefit (19 percent vs. 3 percent, data not shown), reflecting their higher average drug spending. Individuals who have high spending and do not receive the LIS pay 5 percent coinsurance on prescriptions in the catastrophic phase with no limit on annual OOP costs.⁵ In 2018, spending on the 5 percent coinsurance for those enrollees amounted to \$1.3 billion. LIS enrollees who have high spending are also subject to 5 percent coinsurance in the

**TABLE
5-3**

Part D enrollees reaching the benefit's catastrophic phase, 2015-2018

	2015	2016	2017	2018	AAGR, 2015-2018
Number of enrollees reaching OOP threshold (in millions)					
LIS enrollees	2.6	2.6	2.6	2.7	1.3%
Enrollees without LIS	<u>1.0</u>	<u>1.1</u>	<u>1.0</u>	<u>1.1</u>	<u>3.3%</u>
All	3.6	3.6	3.6	3.9	1.9%
Share of all Part D enrollees	8.7%	8.3%	8.0%	8.3%	N/A
Cost-sharing liability in the catastrophic phase (in billions)					
LIS enrollees	\$1.7	\$1.8	\$1.9	\$2.1	1.3%
Enrollees without LIS	<u>0.9</u>	<u>1.0</u>	<u>1.1</u>	<u>1.3</u>	<u>12.7%</u>
Total	2.6	2.8	3.0	3.4	9.9%

Note: AAGR (average annual growth rate), OOP (out-of-pocket), LIS (low-income subsidy), N/A (not applicable). Components may not sum to totals due to rounding.

Source: MedPAC analysis of Part D prescription drug event data.

catastrophic phase, but their cost-sharing obligation is fully covered by Medicare's LICS. For LIS enrollees, in 2018, Medicare's LICS paid about \$2.1 billion for coinsurance in the catastrophic phase.

Under a restructured Part D benefit, beneficiaries would have no cost-sharing liability in the catastrophic phase, providing complete financial protection to enrollees once they reached the OOP threshold (consistent with our 2016 recommendation). This protection would be particularly valuable for beneficiaries with the highest spending who do not receive the LIS. For example, in 2018, of the 1.1 million high-spending enrollees without the LIS, about 110,000 paid \$2,800 or more in cost sharing for prescriptions filled in the catastrophic phase of the benefit.

Under current law, in 2020, the catastrophic phase starts when an enrollee accrues \$6,350 in OOP costs, but brand manufacturer discounts in the coverage gap count toward that amount. A beneficiary who takes the average mix of generic and brand-name drugs would reach that threshold by spending about \$2,750 of their own money and would receive \$3,600 in manufacturer discounts. Beneficiaries who use a higher than average share of generic drugs would need to spend more of their own money to reach the OOP threshold. If the coverage-gap

discount were eliminated in 2020, beneficiaries without the LIS, regardless of their mix of brand-name and generic drugs, would have to pay the full \$6,350 to reach the OOP threshold. For this reason, policymakers could consider a lower catastrophic threshold under a restructured benefit to ensure that beneficiary OOP spending does not exceed the level it would have been had the coverage-gap discount remained.

Eliminating cost sharing in the catastrophic phase would result in higher benefit costs. For example, in 2018, the \$3.4 billion in cost sharing that was paid by enrollees without the LIS and by Medicare's LICS for LIS enrollees would instead have been included in plan bids. In turn, premiums for all Part D enrollees would have increased by roughly \$1.60 per month. Medicare's spending to subsidize the basic Part D benefit for all enrollees would increase by \$2.5 billion (74.5 percent of \$3.4 billion). In the aggregate, premiums would increase by \$0.9 billion, with about \$0.3 billion of that amount covered by Medicare's premium assistance for LIS enrollees. In addition, the policy would likely increase prescriptions filled in the catastrophic phase of the benefit by beneficiaries without the LIS. As a result, effects on Medicare's subsidy payments for Part D's basic benefit costs and enrollee premiums would likely be higher than

the static estimate that assumes no behavioral response. Policymakers could require manufacturers of brand-name drugs to provide a somewhat higher discount in the catastrophic phase to pay for the new financial protections provided to high-cost enrollees. The net effect on Medicare program spending would be an increase of \$0.7 billion (\$2.5 billion in higher spending on the basic benefit and \$0.3 billion in higher LIS spending on premiums, minus \$2.1 billion in lower LICS spending).

Establish a manufacturer discount in the catastrophic phase

In its June 2019 report, the Commission discussed converting the coverage-gap discount to a discount in Part D's catastrophic phase as a way to provide plan sponsors and manufacturers with better formulary and pricing incentives (Medicare Payment Advisory Commission 2019d). In the recommendation described here, the manufacturer discount would apply to prescriptions in the catastrophic phase for both brand-name drugs and biologics (including biosimilars) and generic prescriptions to reach CMS's threshold to be placed on a specialty tier (with an average price of \$670 per month or more in 2020). The manufacturer discount would apply to prescriptions filled in the catastrophic phase by LIS beneficiaries as well as beneficiaries without the LIS.

Compared with the current discount in the coverage gap, a manufacturers' discount in the catastrophic phase would apply more directly to drugs and biologics that command high prices, potentially acting as a drag on price growth. Because the dollar amount of the discount would increase proportionately with the price of the drug, high-priced products would be subject to a larger financial liability than lower priced products. Compared with a manufacturer discount in the coverage-gap phase, some analysts believe that a discount in the catastrophic phase could make the prospect of raising prices less attractive for manufacturers. Others believe that manufacturers would launch new drugs at prices high enough to compensate for the discount liability. The extent to which manufacturers could increase prices or launch new drugs at higher prices would vary by product and would depend on multiple factors, including the degree of competition within a therapeutic class and Medicare's market share of that product. Policymakers could structure the discount so that if average prices of drugs subject to the discount increased faster than a benchmark (such as average Part D spending), the discount rate would increase commensurately.

In 2018, if the coverage-gap discount rate had been 70 percent (as was the case in 2019 and subsequent years), manufacturer discounts would have totaled about \$9 billion. Based on the distribution of claims in 2018, we estimate that Part D would need a manufacturer discount rate in the catastrophic phase of about 15 percent—applied to prescriptions filled by beneficiaries both with and without the LIS—to ensure that the aggregate amount paid by manufacturers would be as large as the amount that would be paid under the current coverage-gap discount program. That estimate is for one year (2018) and does not incorporate any behavioral assumptions about how beneficiaries, plan sponsors, and manufacturers might respond to a discount in the catastrophic phase. The estimate also does not reflect any changes in the distribution of Part D spending in later years as new products entered the market.

Alternatively, a discount in the catastrophic phase could be set at a higher rate to offset other costs of the restructured benefit. Policymakers could also choose to pay for the restructured benefit through higher enrollee premiums, higher Medicare program spending, or both. For example, we estimate that in 2018, a 20 percent discount rate would have been needed to replace the coverage-gap discount and cover the costs of a new OOP cap. An estimated 35 percent rate would have been needed to cover both of those policy changes as well as the costs of eliminating the coverage gap for LIS enrollees. However, it is worth emphasizing that those figures are based on a snapshot of 2018 spending. In future years, as more high-priced drugs enter the market, the share of Part D spending made up of catastrophic benefits is likely to grow. In turn, a discount in the catastrophic phase would cover a larger share of Part D spending, offsetting more of the costs of the expanded benefits. Reflected in the recommendations presented later in this chapter, the Commission chose a manufacturer discount rate of at least 30 percent to include manufacturers among the stakeholders that would bear strong direct effects of drug price increases. A 30 percent discount would also help offset what would otherwise be increases in enrollee premiums and Medicare program spending resulting from Part D's new benefit structure.

Lower Medicare's individual reinsurance and increase plan liability

Part D's individual reinsurance is one component of a system of risk-sharing mechanisms. Before the start of Part D, stand-alone PDPs did not exist. Policymakers initially included Medicare's reinsurance and risk corridors

to encourage plan sponsors to enter this new market and compete. In 2015, the Commission reviewed Part D's tools for sharing risk—reinsurance, risk adjustment, and risk corridors—and discussed whether all three were still necessary in what had by then become an established market (Medicare Payment Advisory Commission 2015).

Reinsurance is one mechanism to give plan sponsors protection against unpredictable variation in pharmacy spending. For commercial and employer health plans, private individual reinsurance (also called individual stop-loss protection) is designed to serve a very specific purpose: to offset the unpredictable financial risk of extremely high claims from a few members. Because most commercial health plans insure both medical and pharmacy benefits, reinsurance contracts written for those plans generally cover both types of spending.

The more generous structure of Medicare's reinsurance and the predictability of most spending covered by Part D reinsurance suggest that individual reinsurance is serving a different function than it does for commercial health plans (Medicare Payment Advisory Commission 2016). In commercial plans, reinsurance typically has a higher spending threshold and may cover only the top 1 percent or 2 percent of enrollees with the highest spending (Bachler et al. 2019, Medicare Payment Advisory Commission 2015). By comparison, Medicare pays reinsurance for about 8 percent of Part D enrollees. Private reinsurers of commercial plans may exclude individuals with predictably high spending from future reinsurance coverage. Rather than acting as a stop loss against unexpectedly high spending, Medicare's reinsurance has been providing targeted cost-based reimbursement for high-cost enrollees, whether spending for those individuals is predictable or not.

The Commission's new approach to restructuring Part D would lower Medicare's reinsurance from 80 percent to 20 percent of catastrophic spending and increase plan sponsors' financial risk for benefit spending. More of Medicare's overall subsidy would be paid through capitated payments, adjusted by risk scores that would be recalibrated to the higher level of plan liability. Those measures would give plan sponsors stronger incentives to manage benefits, which could improve their formulary design decisions. Medicare's overall subsidy would remain unchanged at about 74.5 percent of basic benefits, and the share of basic benefit costs paid by enrollees would remain at about 25.5 percent. Because of the sizable

nature of this shift in risk, policymakers could temporarily tighten Part D's risk corridors to protect plan sponsors and beneficiaries from unintended consequences. The Commission anticipates phasing in its recommendations over several years to give plan sponsors time to adjust to the new benefit structure. After the phase-in period, the Commission could revisit the issue of whether risk corridors are still needed.

A restructured Part D benefit

Table 5-4 (p. 136) compares a recommended restructured Part D benefit with the current defined standard benefit. The restructured benefit would eliminate the coverage-gap discount program that currently applies to enrollees without the LIS as well as the coverage gap for LIS enrollees. Those changes would create a standard benefit structure for all enrollees, and plans would become responsible for 75 percent of benefits between the deductible and the OOP threshold. The restructured benefit would have no beneficiary cost sharing in the catastrophic phase. Medicare's individual reinsurance would be lowered to 20 percent, with plan sponsors responsible for 80 percent of low-priced generics (below the specialty-tier dollar threshold) and 50 percent for all other drugs and biologics. The effects on stakeholders of restructuring Part D in this way would vary depending on the specific parameters chosen. Below, we highlight some key tradeoffs in setting those parameters and considerations for two types of Part D plans: those that serve LIS enrollees and employer group waiver plans.

Tradeoffs between a lower OOP threshold and benefit and premium costs

In 2022, Part D's OOP threshold is projected to be about \$7,100. Under that threshold, enrollees without the LIS who reach the threshold and take an average mix of brand-name and generic prescriptions would pay about \$3,100 themselves and brand manufacturers would provide about \$4,000 in coverage-gap discounts. If the coverage-gap discount program were eliminated, most individuals who now reach the catastrophic phase would not likely reach it as quickly, and some would not reach it at all.

Setting the OOP threshold at \$3,100 in 2022 would ensure that most enrollees reach the catastrophic phase with about the same amount of cost-sharing liability as under current law. If policymakers set the OOP threshold at a lower amount, it would provide greater financial protection for all enrollees. More beneficiaries would reach the

**TABLE
5-4**

The parameters of a restructured Part D benefit

	Current benefit	Restructured benefit
Transition period to the new catastrophic benefit	N/A	4 years
Benefit phases below OOP threshold:		
Enrollee cost sharing between deductible and ICL	25%	25%
Plan liability between deductible and ICL	75%	75%
Coverage gap between ICL and catastrophic phase?	Yes	No
Brand manufacturer discount	70% in coverage gap (prescriptions filled by enrollees without LIS)	None
Projected OOP threshold in 2022	\$3,100 (\$7,100)*	\$3,100
Total spending at OOP threshold	About \$11,000	About \$11,000
Distribution of catastrophic spending (above the OOP threshold):		
Beneficiary cost sharing	5%	0%
Medicare reinsurance	80%	20%
Plan liability	15%	80% for lower priced generics 50% for brands and high-priced generics
Manufacturer discount**	0%	30% for certain prescriptions filled by enrollees with and without LIS

Note: N/A (not applicable), OOP (out-of-pocket), ICL (initial coverage limit), LIS (low-income subsidy).
 *Under current law, in the coverage gap, both beneficiary spending and the 70 percent discount provided by brand manufacturers count toward the OOP threshold. In 2022, at the average mix of brand and generic spending, about \$3,100 of the \$7,100 threshold, would be paid by the beneficiary and \$4,000 would be covered by manufacturer discounts.
 **Would apply to brand-name drugs, biologics, biosimilars, and certain high-priced generic drugs.

Source: Illustrative parameters for MedPAC-recommended changes to Medicare’s Part D benefit structure, 2020.

catastrophic phase of the benefit than under current law. However, because there would be no cost sharing in the catastrophic phase, Part D enrollees who reach the lower OOP threshold would likely use more medications relative to a higher OOP threshold, potentially increasing polypharmacy issues among some beneficiaries. That change, in turn, would tend to put upward pressure on Part D benefit costs and enrollee premiums.

Trade-offs of a higher manufacturer discount in the catastrophic phase

Striking the right balance between plan and manufacturer liability will be crucial in providing better plan incentives

while restraining high price growth. In the restructured benefit shown in Table 5-4, the catastrophic benefit would consist of lower Medicare reinsurance (20 percent), a new manufacturer discount (30 percent), and plan liability (50 percent for brand-name drugs, high-priced generics, and biologics and 80 percent for lower priced generic drugs). Increasing plan liability from the current 15 percent to a higher percentage is important in providing plan sponsors with stronger incentive to manage spending.

If policymakers were to select a manufacturer discount lower than 30 percent, plans would bear more insurance risk, which would provide them with stronger incentives to manage spending. Plans might also negotiate harder

for rebates but would still have limited ability to negotiate rebates for unique therapies. However, benefit costs and enrollee premiums would both be higher.

The Commission chose to recommend a manufacturer discount of at least 30 percent to discourage price increases and to help offset increases in benefit costs and enrollee premiums. Because the new manufacturer discount would apply more directly to high-priced products, it could be particularly useful for therapies in drug classes that have few or no competitors. Under a reform in which the discount rate in the catastrophic phase would increase proportionately with the average growth in catastrophic spending, manufacturers could be deterred from raising prices. However, the effectiveness of the discount at restraining price growth would vary across manufacturers and would depend on Medicare's share of each product's market. In addition, if a higher manufacturer discount further reduced plan sponsors' liability, on the margin, that could weaken plan incentives to manage spending. For that reason, if the discount were structured to increase beyond 30 percent commensurately with growth in average catastrophic prices, policymakers could consider reducing the share of catastrophic benefits paid through Medicare's reinsurance rather than reducing plans' share.

Considerations for plans serving low-income beneficiaries

In 2017, LIS enrollees made up 71 percent of beneficiaries with spending high enough to reach Part D's catastrophic phase. Most LIS beneficiaries are in plans that serve large numbers of LIS enrollees, including basic stand-alone PDPs and a type of specialized MA plan known as a dual-eligible special needs plan (D-SNP). The Commission's recommended Part D reforms would require plans to bear more financial risk by expanding the use of capitated payments and reducing the use of cost-based payments for the LICs and reinsurance. To ensure stability in plan options for LIS beneficiaries, policymakers would need to phase in the new structure of Medicare's subsidies over several years. New tools would help plan sponsors better manage drug spending for LIS enrollees, and CMS would need to recalibrate the Part D risk adjustment system to reflect the higher plan liability.

A significant number of Part D plans serve primarily LIS enrollees LIS enrollment varies across plans, largely due to deliberate policy choices in both the Part D and MA programs. Medicare encourages LIS beneficiaries to enroll in basic PDPs by setting the maximum amount

the program will pay for low-income premium subsidies at regional benchmarks calculated from plans' premiums for basic coverage. In 2019, of the 7.3 million LIS beneficiaries enrolled in stand-alone PDPs, more than 90 percent were in plans that offered basic coverage. In that year, LIS beneficiaries accounted for 55 percent of enrollees in basic PDPs. Of the LIS beneficiaries in PDPs, 95 percent were enrolled in PDPs offered by five large companies—CVS Health, UnitedHealth Group, Humana, WellCare (recently purchased by Centene), and Cigna (including its subsidiary Express Scripts).

Of the 5 million LIS beneficiaries enrolled in MA-PDs in 2019, just over half (2.5 million people) were in traditional plans and another 45 percent (2.2 million people) were in D-SNPs.⁶ Traditional MA-PDs are open to all beneficiaries in a plan's service area, but special needs plans are limited to certain types of beneficiaries, with D-SNPs serving dual eligibles. As a result, LIS beneficiaries account for a relatively small share of enrollment in traditional MA-PDs (18 percent) but account for virtually all D-SNP enrollment.⁷ LIS enrollment in MA-PDs is less concentrated among a few major companies than is LIS enrollment in PDPs. In addition to large, vertically integrated health plans, MA plan sponsors include a broader variety of companies such as smaller regional organizations, religious-affiliated groups, and integrated delivery systems. However, most sponsors of smaller MA-PDs contract with large pharmacy benefit managers (PBMs) to provide outpatient drug benefits and negotiate postsale rebates and discounts with drug manufacturers and pharmacies.⁸

In 2019, there were 1,021 Part D plans in which LIS beneficiaries made up the majority of each plan's enrollees (Table 5-5, p. 138). (Those majority-LIS plans made up about one-quarter of all Part D plans in 2019 (data not shown).) Those plans covered about two-thirds of the LIS population (8.2 million out of 12.7 million), with most individuals enrolled in basic PDPs and D-SNPs.

Monitor effects of restructuring on MA-PDs that serve mostly LIS enrollees The reforms would result in higher capitated payments (consisting of Medicare's direct subsidy payments to plans and premiums paid by enrollees and by Medicare for LIS enrollees) for all enrollees, but the impact for LIS beneficiaries would be larger. Table 5-6 (p. 139) shows how 2017 spending was financed for beneficiaries with and without the LIS and demonstrates how the role of each funding stream would change under the Commission's recommended reforms.

**TABLE
5-5**

A significant number of Part D plans served primarily LIS beneficiaries, 2019

	Plans	Enrollees (in thousands)		Average share of enrollees	
		With LIS	Without LIS	With LIS	Without LIS
Plans with majority-LIS enrollment					
Basic PDPs	187	5,124	2,387	68%	32%
Traditional MA-PDs	150	334	80	81	19
C-SNPs	14	49	4	92	8
D-SNPs	413	2,238	8	100	<1
I-SNPs	81	78	4	95	5
MMPs	50	380	1	100	<1
PACE	126	43	1	99	1
Total	1,021	8,246	2,485	77	23

Note: LIS (low-income subsidy), PDP (prescription drug plan), MA-PD (Medicare Advantage-Prescription Drug [plan]), C-SNP (chronic condition special needs plan), D-SNP (dual-eligible special needs plan), I-SNP (institutional special needs plan), MMP (Medicare-Medicaid Plan), PACE (Program of All-Inclusive Care for the Elderly). Figures based on Part D enrollment data for April 2019. Does not include plans in the U.S. territories.

Source: MedPAC analysis of CMS Part D enrollment data.

Under this reform package, Medicare’s capitated payments to plans would account for a substantially larger share of total spending, rising from 28 percent to 58 percent for LIS beneficiaries and from 40 percent to 60 percent for the other Part D beneficiaries. The share of spending financed by Medicare’s reinsurance and the LIS would decline, but it is worth noting that they and the other types of funding would still account for about 40 percent of total spending.

In dollar terms, the recommended reforms would lead to higher capitated payments for both kinds of beneficiaries, but the increase for LIS beneficiaries would be larger. The average monthly capitated payment for LIS beneficiaries would more than double, rising from \$139 to \$289, while the average payment for Part D beneficiaries without the LIS would rise from \$87 to \$130. The increase for LIS beneficiaries, \$150, would be larger because these beneficiaries have higher gross spending, on average, than Part D beneficiaries without the LIS and because the majority of that spending is currently financed through Medicare’s reinsurance and the LICS (40 percent and 31 percent, respectively). In contrast, Medicare’s reinsurance payments for beneficiaries without the LIS account for 23 percent of gross drug spending. Under the recommended reform package, Medicare’s payments for reinsurance and

the LICS would be lower but would be mostly offset by higher capitated payments. As a result, capitated payments for LIS beneficiaries would be an average of 2.2 times higher than capitated payments for Part D beneficiaries without the LIS (compared with 1.6 times higher under the current program).

Because of the differences between LIS and the other Part D beneficiaries, we interviewed several plan sponsors and actuaries with Part D plan expertise to learn about their experience with the LIS population. These sponsors consisted of a mix of large, for-profit companies that operate both stand-alone PDPs and MA-PDs and smaller, nonprofit companies that operate regional MA-PDs. Each sponsor had at least one plan, such as a basic PDP or D-SNP, in which most of the enrollees were LIS beneficiaries. Although interviewees were not drawn from a representative sample of all majority-LIS plans, their comments helped to highlight issues that policymakers could consider related to restructuring Part D.

There was broad agreement among interviewees that Part D reforms should be phased in to give plans time to adjust to the added financial risk and to avoid unnecessary disruptions. All interviewees emphasized

**TABLE
5-6**

An illustrative example of how the Commission’s recommended reforms would affect spending for LIS enrollees versus other Part D enrollees

	Average gross spending (per enrollee per month, 2017)			Distribution of gross spending	
	Actual	Under reformed benefit	Change	Actual	Under reformed benefit
LIS enrollees					
Total gross drug spending	\$502	\$502	\$0	100%	100%
Medicare reinsurance	202	50	-152	40	10
Capitated payments	139	289	150	28	58
LICS	155	81	-74	31	16
Manufacturer discounts in catastrophic phase	0	75	75	0	15
Out-of-pocket spending	6	6	0	1	1
Other Part D enrollees					
Total gross drug spending	\$218	\$218	\$0	100%	100
Medicare reinsurance	49	12	-37	23	6
Capitated payments	87	130	43	40	60
Manufacturer coverage-gap discounts	16	0	-16	7	0
Manufacturer discounts in catastrophic phase	0	18	18	0	8
Out-of-pocket spending	44	36	-8	20	17
Other	21	21	0	10	10
Ratio of LIS capitated payments to other Part D beneficiaries’ capitated payments	1.6	2.2			

Note: LIS (low-income subsidy), LICS (low-income cost-sharing subsidy). “Other Part D enrollees” refers to Part D enrollees without the LIS. “Gross spending” refers to amounts paid at the pharmacy before postsale rebates and discounts. The “under reformed benefit” columns show the combined effects of the following Part D reforms: eliminating the coverage gap for LIS enrollees, eliminating the coverage-gap discount program, adding an annual cap on beneficiary out-of-pocket costs, lowering the use of reinsurance in the catastrophic phase from 80 percent to 20 percent, requiring manufacturers of brand-name drugs to provide a discount of 30 percent on brand-name drugs and high-cost generic drugs used in the catastrophic phase, and increasing the share of catastrophic benefits financed by capitation payments from 15 percent to 50 percent for brands and generics and 80 percent for all other drugs. Capitated payments consist of Medicare’s direct subsidy payments to plans and premiums paid by enrollees and LIS for LIS enrollees. The “other” figures include payments by patient assistance organizations and third-party payers other than Part D plans that reduce beneficiary cost-sharing liability. Figures do not incorporate behavioral responses by plans and beneficiaries that would change total gross drug spending. Figures do not reflect the effects of postsale rebates and discounts and thus cannot be used to estimate the effect that the proposed reforms would have on Part D premiums. Components may not sum to totals because of rounding.

Source: MedPAC analysis based on average monthly spending amounts per enrollee with and without the LIS in 2017 Part D prescription drug event data.

that the Part D risk adjustment model would need to be recalibrated to ensure that payments for LIS beneficiaries remained adequate.

Interviewees distinguished between the new liability that plans would bear for what is now coverage-gap spending compared with higher plan liability in Part D’s catastrophic phase. Our interviewees did not believe that requiring plans to cover 75 percent of costs in the coverage gap would pose the same risk as the catastrophic benefit

costs because coverage-gap spending falls within a narrow range and is relatively predictable. However, interviewees expressed concern that payment rates for some high-cost beneficiaries might be too low. The primary concern was that even with higher capitated payments, reductions in Medicare’s reinsurance could lead to an increase in “high-cost outlier” cases in which risk-adjusted payments were substantially below actual costs. One interviewee said that Medicare should continue to use reinsurance to cover at

least some spending in the catastrophic phase because that would take some pressure off the risk adjustment system (i.e., CMS’s risk adjustment model would not need to predict spending for high-cost beneficiaries as accurately as it otherwise would).

Interviewees said that smaller plans, such as regional MA–PDs, would be more vulnerable to high-cost outliers, but when asked, they did not provide specifics on how a “smaller plan” might be defined. They noted that some plan sponsors might respond by purchasing private reinsurance to limit their potential exposure—although one sponsor said the profit markups on this coverage would make it prohibitively expensive—and said that policymakers could provide additional protection while the reforms were being implemented by modifying Part D’s risk corridors.

We also examined data on Part D’s risk corridor payments for 2015, the most recent available, to compare the performance of plans in which LIS beneficiaries made up the majority of enrollees with the performance of other plans. The risk-corridor data show how the actual costs that plans incurred to provide Part D benefits compared with the assumptions plans used in their bids. We found that bids for majority-LIS plans were about as accurate as bids for other plans, indicating that majority-LIS plans could accurately predict the costs for their enrollees and were not at greater risk of unexpected financial losses. In addition, majority-LIS plans typically did a better job of predicting how much of their enrollees’ drug spending would be covered by the LICS. Because the recommended reforms would take some spending that Medicare’s LICS now covers and make it part of the basic Part D benefit, these findings suggest that majority-LIS plans would be able to accurately account for the effects of those changes when they developed their bids.

Considerations for employer group waiver plans

Employer group waiver plans (EGWPs) are sponsored by employers that contract directly with CMS or on a group basis with an insurer or PBM to administer the Part D benefit. They differ from employer plans that receive Part D’s retiree drug subsidy (RDS) in that Medicare is the primary payer rather than the employer.⁹ Under accounting standards, private employers and state and local governments are required to calculate and report their unfunded liabilities for future pensions and other postemployment retirement benefits such as for prescription drugs. By putting retirees into EGWPs that benefit from both Medicare’s general Part D subsidy

as well as manufacturer discounts in the coverage gap, employers substantially reduce the magnitude of their unfunded liability.

EGWPs have distinct characteristics from other Part D plans. As a result, certain pieces of the recommended Part D reforms are likely to have a different impact on EGWPs than on other plans. One key difference is that EGWPs do not submit bids. Instead, Medicare pays EGWPs based on the national average of bids from nonemployer Part D plans. Another difference is that EGWPs are not eligible for risk-corridor payments. Under the restructured benefit, plan bids would increase to reflect their higher liability for benefit costs in the coverage gap and the catastrophic phase. In turn, Medicare’s direct subsidy payments to EGWPs would also increase.

EGWPs receive a disproportionate share of coverage-gap discounts: In 2018, EGWPs had 16 percent of Part D enrollees but received 45 percent of coverage-gap discounts (Medicare Payment Advisory Commission 2020b). EGWPs received more discounts because they tend to offer more generous benefits that supplement the standard Part D benefit. Under Part D’s “true out-of-pocket” provision, those supplemental benefits do not count as an enrollee’s OOP costs. As a result, EGWP enrollees who reach the coverage gap tend to stay there longer than enrollees without supplemental coverage. EGWPs also receive more discounts because they have very few LIS enrollees and thus a higher share of enrollees eligible for the discounts. In 2018, 98 percent of enrollees in EGWPs were eligible for coverage-gap discounts because they did not receive the LIS, compared with the roughly two-thirds of enrollees in other Part D plans. As a result, eliminating the coverage-gap discount under the reform would likely have a larger financial impact on EGWPs than on other Part D plans.

Under the reformed benefit, there would be a new manufacturer discount in the catastrophic phase that would apply to all enrollees. However, if EGWPs continued to provide supplemental benefits that prevented or delayed enrollees from reaching the catastrophic phase of the benefit, EGWPs would receive fewer manufacturer discounts than they do now. At the same time, because CMS would need to go through the rule-making process to implement the restructured benefit, we expect employers would have time to adjust their benefit offerings or switch to providing the prescription drug benefit through an RDS-eligible plan before facing the full financial impact of the reform.

Other modifications to Part D associated with a restructured benefit

The Commission believes that a Part D reform package that requires plan sponsors to assume greater financial risk should include complementary reforms to provide plan sponsors with greater flexibility to manage drug spending. In its June 2016 recommendations, the Commission included modifying the LIS to encourage greater use of lower cost drugs, removing protected status from two of the six drug classes for which plan sponsors must now cover all drugs on their formularies, streamlining the process for formulary changes, requiring prescribers to provide supporting justifications with more clinical rigor when applying for exceptions, and permitting plan sponsors to use selected tools to manage specialty-drug costs.¹⁰ Part D's risk adjustment system would be recalibrated, and risk corridors could be modified as well.

Part D plan sponsors use formulary tools to manage benefits, but are subject to more constraints than commercial plans

The universe of drugs that Part D plans can cover generally includes, with a limited number of exceptions, any outpatient prescription agent approved by the Food and Drug Administration whose manufacturer has signed a contract with CMS to provide statutory rebates in the Medicaid program.¹¹ From that range of products, the pharmacy and therapeutics committee of each Part D plan sponsor selects specific drugs and biologics to include on its formulary. Those selections are based on considerations about therapeutic effectiveness as well as the relative price of competing products, net of any rebates and discounts negotiated with manufacturers and pharmacies. To make sure that each plan's formulary design does not substantially discourage enrollment by certain eligible individuals, CMS reviews plan formularies to check that they include medicines in a wide range of therapeutic classes used by the Medicare population. For most drug classes, plans must cover at least two chemically distinct drugs, as well as "all or substantially all drugs" in six protected classes—anticonvulsants, antidepressants, antipsychotics, immunosuppressants, antiretrovirals, and antineoplastics.

Sponsors manage the Part D benefit using the same strategies they employ for commercial clients: designing tiered formularies with differential cost sharing to encourage use of lower cost drugs, which gives sponsors leverage in negotiations with drug manufacturers for rebates. Plan sponsors may use utilization management

tools such as prior authorization and step therapy to encourage enrollees to use generics and preferred drugs or to help ensure patient safety. In general, plan sponsors would have the greatest leverage for price concessions when they can credibly threaten not to cover a drug on their formularies. However, sponsors are subject to more regulatory oversight in Part D than in the commercial sector, and CMS must approve each plan's formulary and utilization management requirements. Some Part D regulations, such as the protected-class policy, expand beneficiaries' access to drug therapies but can also reduce plan sponsors' negotiating leverage with manufacturers. The policy likely contributes to the high prices of some drugs in the protected classes (Centers for Medicare & Medicaid Services 2018b, Kocot et al. 2019).

Medicare also requires plan sponsors to establish a process for coverage determination and appeals. There are limits as to what available data can tell us about how well Part D's exceptions and appeals processes work. Nevertheless, CMS data show that in 2017, 3.5 percent of Part D transactions were rejected at the pharmacy because the drug was not on the plan's formulary or because of plan requirements for prior authorization, quantity limits, or step therapy (Office of Inspector General 2019). Of those reported rejections, about 10 percent proceeded to a plan coverage determination, and more than 70 percent of those claims were ultimately approved in favor of the patient by either the plan itself or by an independent review entity.

A more constructive approach toward ensuring appropriate access would be to provide enrollees and prescribers with real-time information about formulary coverage and utilization management requirements. (See text box on resolving coverage issues at the point of prescribing, p. 142.) These tools could reduce the need for appeals and increase the likelihood that beneficiaries receive an appropriate medicine in a timely manner. If built into the prescriber's workflow, standardized approaches to real-time benefit check, electronic prior authorization, and automated coverage determinations could also save patients and providers significant time and resources and speed up delivery of care (American Medical Association–convened workgroup of 17 state and specialty medical societies 2019).

Part D's low-income cost-sharing subsidy limits out-of-pocket costs, but also reduces incentives to use lower cost drugs

The cost-sharing subsidy sharply reduces OOP costs for LIS beneficiaries. Medicare pays for the deductible and

Resolving coverage issues at the point of prescribing

Rather than relying on the exceptions and appeals process, a better approach to resolving questions about coverage would be to use electronic tools such as real-time benefit tools (RTBTs) and electronic prior authorization (ePA).

For several years, health plans and pharmacy benefit managers (PBMs) have operated portals that prescribers could use to look up formulary and benefit (F&B) information. However, portals can be time consuming because they fall outside the regular workflow of prescribers, and providers typically need to navigate several portals for information across their patient panel. Part D plan sponsors currently are required to disseminate F&B information on a nightly, weekly, or monthly schedule, but that approach does not provide patient-specific data. Even when available, physicians may ignore F&B information because they have experienced inaccuracies or because it is displayed in a confusing manner. Physicians in one recent roundtable said they would like to know the approximate cost-sharing amount their patients would pay for various medicines rather than just formulary status and cost-sharing tier (BenMedica 2019). In addition, beneficiaries would also like to know the drug's cash price (to decide whether to use their plan benefit) as well as the availability of cost-sharing assistance (CoverMyMeds 2020).

By comparison, RTBTs operate as a module within a patient's electronic health record (EHR). RTBT technology allows the prescriber to see patient-specific details about benefits—such as whether a drug is covered on a formulary, alternative drugs that are covered, prior authorization requirements, total drug cost, beneficiary cost sharing, and pharmacy network status—before ordering a prescription. ePA tools allow the prescriber to submit a request to the patient's plan in real time and, for automated plan reviews, potentially receive approval much more quickly than manual plan reviews. After receiving an ePA approval, the prescriber

orders the prescription and sends it to the desired pharmacy for dispensing.

Part D plan sponsors have long been required to support electronic prescribing, which in 2018 was used by approximately 73 percent of prescribers and 99 percent of pharmacies (SureScripts 2018). In 2019, CMS finalized a rule (CMS-4180-F) requiring Part D sponsors to implement one or more RTBTs capable of integrating with at least one prescriber's EHR system by January 1, 2021. However, the extent to which this requirement increases the use of RTBTs in Part D will depend on the degree to which clinicians—who face no requirements under this rule—adopt them when prescribing for their Medicare patients.

Although many EHR vendors, payers, and PBMs already support RTBTs and ePA, phone and fax continue to be the most common ways of completing prior authorization (American Medical Association 2019, CoverMyMeds 2020). One key reason is that the electronic tools do not communicate with all relevant PBMs. For example, SureScripts, which is partly owned by CVS Health and Express Scripts, does not include RTBT data from OptumRx, which is owned by UnitedHealthcare, while OptumRx's tool does not support CVS Health or Express Scripts (Galewitz 2019). There are no industry-wide electronic standards for using the electronic tools, and certain proprietary features of EHRs prevent systems from communicating with one another.

Perhaps the most essential requirement for adoption of electronic tools is clinician acceptance and use, which can require paying fees to vendors and embracing practice pattern change. Some prescribers may not be aware of the tools. According to one recent survey, only 21 percent of physicians reported that they knew their EHR system offered ePA (American Medical Association 2019). In addition, some prescribers require demonstration that the tools could lead to efficiencies rather than contribute to greater workload. ■

coverage gap for most LIS enrollees, and Part D law also sets maximum amounts that LIS beneficiaries pay for each prescription, which cannot be modified by CMS or plan sponsors. In 2017, LIS enrollees paid, on average, \$6 per

month out of pocket, or about 1 percent of their average gross drug spending of \$502 per month. By comparison, all other enrollees paid an average of \$44 per month out of pocket, or about 20 percent of their average gross

**TABLE
5-7**

LIS beneficiaries have weaker incentives to use lower cost drugs

Cost sharing in 2020

Formulary tier	Drug category	Median for stand-alone Part D plans	Maximum for LIS beneficiaries
Tier 1	Preferred generic drugs	\$0 copayment	\$3.60 copayment or less for most beneficiaries
Tier 2	Other generic drugs	\$3 copayment	
Tier 3	Preferred brand-name drugs	\$42 copayment	\$8.95 copayment or less for most beneficiaries
Tier 4	Nonpreferred drugs	38% coinsurance	
Tier 5	Specialty drugs	25% coinsurance	

Note: LIS (low-income subsidy). Some stand-alone Part D plans use copayments for drugs on Tier 3 while others use coinsurance; roughly 75 percent of enrollees are in plans that use copayments. The maximum cost sharing for an individual LIS beneficiary depends on several factors in addition to the drug’s brand/generic status, such as whether the beneficiary receives Medicaid-funded long-term services and supports and whether the beneficiary has reached Part D’s out-of-pocket threshold for catastrophic coverage.

Source: Centers for Medicare & Medicaid Services 2019a, Cubanski and Damico 2019.

spending of \$218 per month (Medicare Payment Advisory Commission 2019b).

Although the LIS helps ensure access to medicines, its limits on cost sharing also give LIS enrollees weaker incentives to use lower cost drugs and make it more difficult for plan sponsors to manage enrollees’ drug spending. For enrollees without the LIS, plan sponsors set cost-sharing requirements with strong incentives to select lower cost drugs (Table 5-7). For example, in 2020, the median copayment in stand-alone PDPs is \$0 for preferred generics and \$3 for other generics, compared with a median copayment of \$42 for preferred brand-name drugs (Cubanski and Damico 2019). Cost sharing was higher still for nonpreferred drug tiers and specialty tiers.¹² For the cost-sharing structure shown in Table 5-7, the savings to an LIS enrollee from taking a generic over a brand-name drug would be just over \$5 (\$8.95 minus \$3.60), but for the other Part D enrollees, the savings would be on average \$39 (\$42 minus \$3). Likewise, LIS enrollees have no incentive to use a plan’s preferred brand-name drug rather than other brand-name drugs because they would pay \$8.95 regardless.

Plan sponsors we interviewed indicated that managing spending and prescription use of LIS enrollees was more difficult than for other enrollees. In their view, the differential between copayments for generic and brand-

name drugs (about \$5) did not provide enough financial incentive for beneficiaries to use generics. Likewise, charging the same copayment for all brand-name drugs gave beneficiaries no incentive to use lower cost brands. Interviewees also noted that a number of LIS enrollees seek nonformulary exceptions for brand-name drugs that have generic equivalents, requiring the plan to cover a product not normally included on its formulary. Large numbers of nonformulary exceptions tend to undermine plan sponsors’ bargaining leverage in their negotiations with manufacturers for rebates. Nonformulary exceptions may be clinically warranted in some cases. However, for enrollees without the LIS who seek such an exception, they typically must pay the cost sharing of their plan’s nonpreferred tier.

Interviewees also reported that managing drug spending for LIS beneficiaries was more difficult because these enrollees were more likely to use drugs in Part D’s protected classes. Medicare’s requirement that plans cover “all or substantially all” drugs in the six classes ensures that beneficiaries who have conditions for which drugs play a key role in treatment have broad access to coverage. However, because manufacturers know that their products cannot be excluded from plan formularies, the policy also limits plan sponsors’ ability to obtain rebates on brand-name drugs. One recent study found that manufacturers provided rebates on fewer brand-name drugs in the

protected classes (13 percent vs. 36 percent of all brand-name drugs) and that the rebates they did provide were smaller (14 percent of gross costs vs. 30 percent for all brand-name drugs) (Johnson et al. 2018).

Claims data show that the generic dispensing rate (GDR)—the share of prescriptions filled with generic drugs—has consistently been lower for LIS enrollees. In 2017, LIS beneficiaries had a GDR about 5 percentage points lower than that for other enrollees (85 percent vs. 90 percent). A representative of one sponsor we interviewed noted that even though differences in GDRs may not seem large, brand-name drugs are many times more expensive than most generics, and so lower use of generics by LIS beneficiaries has a material impact on plan costs. Lower generic use may partly reflect clinical differences, such as having a condition for which all available therapies are brand-name drugs. Nevertheless, regarding therapeutic classes for which all or most drugs have lost patent protection, claims data show that LIS enrollees are less likely to use generics. For example, in 2017, LIS beneficiaries had lower GDRs than other beneficiaries for proton pump inhibitors (88 percent vs. 97 percent), statins (96 percent vs. 99 percent), and certain antidepressants (92 percent vs. 98 percent). These differences suggest that clinical factors alone cannot fully explain lower generic use among LIS beneficiaries.

Greater flexibility in formulary management

Formulary design is the key tool used by plan sponsors to manage drug benefits and affect sponsors' bargaining leverage with pharmaceutical manufacturers. The Commission expects that any policy change that requires plan sponsors to bear more insurance risk would be combined with other changes that would provide sponsors with greater flexibility to use formulary tools. In addition, the Secretary could consider other regulatory changes that would provide plan sponsors with more flexibility while maintaining beneficiary access to clinically appropriate medications.¹³

Allow plans to use a nonpreferred tier for specialty drugs

Under CMS's current guidance, plan sponsors may place drugs that cost \$670 per month or more on a specialty tier.¹⁴ Between 2007 and 2017, spending for specialty-tier drugs grew more than 10-fold—from \$3.4 billion to \$37.1 billion (Medicare Payment Advisory Commission 2019d). Spending for specialty-tier prescriptions made up nearly a quarter of gross Part D spending by 2017 (up from

5.5 percent in 2007), and likely an even larger share of spending after accounting for rebates and discounts.¹⁵

Some commercial plans have two specialty tiers (preferred and nonpreferred) to manage the use of specialty drugs. Such a tier structure could, if appropriately used, enhance patient care by providing access to specialty drugs while reducing inappropriate use. This tier structure could also encourage competition among existing specialty drugs that are therapeutic substitutes and could help encourage beneficiaries to consider using biosimilar products when they become available. Because more expensive or less clinically effective therapies could be placed on the nonpreferred tier, rather than be excluded from the formulary, this tier structure could reduce the need for nonformulary exceptions.

In February 2020, CMS proposed a policy to allow a second, "preferred" specialty tier in Part D with a lower cost-sharing amount (CMS-4190-P). CMS designed the proposal to give plan sponsors more tools to manage the drug benefit, and the Commission shares that goal. Nevertheless, the Commission noted in its comment letter that CMS's proposal may constrain plan sponsors in their design of new specialty tiers and keep them from being as effective as they could be (Medicare Payment Advisory Commission 2020a). The Commission encourages CMS to provide sponsors with greater flexibility to ensure they have meaningful tools to manage specialty-drug spending and leverage to negotiate rebates with manufacturers.

Differentiate LIS cost sharing for preferred and nonpreferred drugs

Plan sponsors, both in Part D and in the commercial market, routinely use differential cost sharing to make generics and lower cost drugs and biologics more attractive to enrollees. However, current LIS copayments provide much weaker financial incentives than those faced by other enrollees. If plan sponsors are to take on more risk for LIS enrollees, additional tools would help them better manage spending for this population.

In 2016, the Commission recommended that the Congress change Part D to modify LIS copayments to encourage the use of lower cost therapies in selected therapeutic classes (Medicare Payment Advisory Commission 2016). Those modifications could take the form of both decreases in cost sharing (e.g., zero copayments for preferred generics) and modest increases for certain nonpreferred prescriptions. To protect beneficiaries, under the recommendation, the Secretary would have authority to select therapeutic

**TABLE
5-8**

Illustrative example of requiring LIS beneficiaries to pay higher cost sharing for certain drugs

LIS beneficiaries

Drug category	Beneficiaries without the LIS	Current cost-sharing limit	Cost-sharing limit under policy
Generic	\$0 copayment	\$3.60*	
Other generic	\$3 copayment	\$3.60	No change*
Preferred drug (largely brands)	\$42 copayment	\$8.95	
Preferred specialty	15% coinsurance	\$8.95	
Nonpreferred drug (largely brands)	38% coinsurance	\$8.95	Modestly higher limits would apply*
Nonpreferred specialty	35% coinsurance	\$8.95	

Note: LIS (low-income subsidy).

*If the plan's standard cost-sharing amount is lower than the limit, LIS beneficiaries pay the standard amount. For example, under current law, the actual amount that LIS beneficiaries pay for drugs on the generic tier would be \$0.

Source: Cubanski and Damico 2019; CMS Office of the Actuary.

classes to which this policy would apply—classes that have generics or biosimilars available and for which substitution would be clinically appropriate.

Consistent with the 2016 recommendation, policymakers could consider allowing modestly higher cost sharing if an LIS beneficiary chooses to fill a prescription for a nonpreferred drug rather than an alternative on a preferred drug tier. (See text box on how low-income beneficiaries respond to cost sharing, pp. 146–147.) As is the case for the other Part D beneficiaries who seek a nonformulary exception, LIS beneficiaries who do so would pay the LIS copayment amount for nonpreferred tiers. Policymakers could also apply differential cost sharing to high-cost specialty drugs by allowing Part D plans to have separate preferred and nonpreferred tiers for specialty drugs. Plan formularies thus could have up to six tiers since there effectively could be two generic tiers as well as separate preferred and nonpreferred tiers for brand-name drugs and specialty drugs. The current LIS limits on cost sharing could still apply to the generic tiers and the preferred tiers; since plans must include at least one drug in each therapeutic class on a preferred tier, this policy would help ensure that LIS beneficiaries still had good access to coverage. Under this policy to include a new statutory LIS copayment amount for nonpreferred drugs and nonformulary exceptions, plans would make LIS enrollees

and their prescribers aware of preferred and nonpreferred therapeutic options for the patient as well as the relevant LIS copayment amounts.

Table 5-8 provides an illustrative example of how differential cost sharing could work for LIS beneficiaries. In this example, which focuses on LIS beneficiaries who currently pay \$3.60 for generics (the maximum copayment for drugs on the two generic tiers) and \$8.95 for brands, the preferred drug tier (which is largely brands) and the preferred specialty tier would remain the same, but the limits for the nonpreferred drug tier (again, largely brands) and the nonpreferred specialty tier would increase somewhat. However, differential cost sharing would not apply to those LIS beneficiaries who pay no cost sharing.¹⁶

Give plans greater flexibility in the protected drug classes

Medicare's requirement that plans cover all drugs in the six protected classes makes it harder for plans to obtain rebates and manage drug spending. Several sponsors said that plans would have an easier time managing drug costs for LIS beneficiaries if some of the restrictions on the protected drug classes were modified. For example, one sponsor said that most drugs in some protected classes have lost their patent protection and that many enrollees can now be effectively treated with generics. However, the

How low-income beneficiaries respond to cost sharing on prescription drugs

Researchers have consistently found that cost sharing reduces overall spending on prescription drugs, with one review of the literature concluding that a 10 percent increase in cost sharing reduces overall prescription drug spending by between 2 percent and 6 percent. Some studies have found that the sensitivity to cost sharing depends on the drug and that higher cost sharing has a smaller effect on the use of more essential drugs, such as those for chronic conditions. Research has also generally found that, for people with chronic conditions such as diabetes or schizophrenia, higher cost sharing for prescription drugs is associated with higher medical costs for services like inpatient care and emergency care. Although there is a widespread belief that low-income populations may be more sensitive to changes in cost sharing, “there is little reliable evidence to support this contention” (Goldman et al. 2007).

Most of the research on the effects of prescription drug cost sharing on low-income groups has looked at the experience in Medicaid (Goldman et al. 2007).

States can charge nominal copayments of up to \$4 for preferred drugs and \$8 for nonpreferred drugs (Medicaid and CHIP Payment and Access Commission 2018). As of 2018, 35 states and the District of Columbia have copayments for prescription drugs, usually ranging between \$0.50 and \$3 per prescription (Kaiser Family Foundation 2018). Research on the introduction of state copayments has found that even modest copayments can significantly affect prescription drug spending (Goldman et al. 2007). One study of Oregon’s Medicaid program found that the introduction of drug copayments did not lead to greater use of inpatient care or emergency care, even among individuals with chronic conditions (Hartung et al. 2008).

Two more-recent studies focusing on low-income populations examined the effects of modifying cost sharing for a subset of drugs, instead of applying cost sharing across all drugs. This targeted approach is more analogous to increasing cost sharing for nonpreferred drugs only. Both studies are somewhat cautionary tales.

(continued next page)

sponsor said that the potential savings from these generics have not been fully realized because the sponsor has had to cover several brand-name drugs that are new formulations of older medications but are not, in its view, any more effective.

The “protected class” policy was intended to ensure that beneficiaries who were transitioning from other drug coverage (e.g., Medicaid) to the Part D program would have uninterrupted access to medications in six classes. Currently, plan sponsors may apply utilization management to protected-class drugs and place therapeutic alternatives in protected classes on different cost-sharing tiers. However, because LIS cost-sharing amounts are set by law rather than by plans, the LIS enrollee does not face the same incentives to use the preferred product as other plan enrollees. More generally, the requirement to cover “all or substantially all” drugs in protected classes reduces plan sponsors’ bargaining leverage with manufacturers;

rebates are less easily obtained and are smaller, on average, for brand-name drugs in protected classes (Johnson et al. 2018). If LIS cost sharing were modified to allow differential copayments between preferred and nonpreferred drugs, plan sponsors would have more bargaining leverage with manufacturers for rebates.

The Commission has previously expressed support for giving plans greater flexibility with the protected classes. In 2016, we recommended removing antidepressants and immunosuppressants from the protected classes (Medicare Payment Advisory Commission 2016). In 2019, we supported a CMS proposal that would make it easier for plans to use formulary management tools in the protected classes (Medicare Payment Advisory Commission 2019a).¹⁷ The proposal would have allowed plan sponsors to use formulary tools more broadly under specific circumstances (e.g., use prior authorization to determine whether a drug was prescribed for a protected-

How low-income beneficiaries respond to cost sharing on prescription drugs (cont.)

The first study looked at changes to the copayments for prescription drugs in the Massachusetts Medicaid program (Lieberman et al. 2014). The state initially charged \$1 for generics and \$3 for brands. The state then raised the copayment for most generics from \$1 to \$3 but kept the \$1 copayment for certain targeted drug classes (antihypertensives, antihyperlipidemics, and hypoglycemics). The copayment for brand-name drugs did not change. The study found that, within the targeted drug classes, use of generic drugs increased while use of brands stayed the same. Higher generic usage was due to higher overall use in the targeted drug classes, rather than individuals switching from brands to generics. More importantly, the study found that elsewhere in the program, use of brand-name drugs increased and generic use decreased because enrollees no longer had an incentive to use generics. These findings underscore that even modest changes to cost sharing can affect patterns of prescription use. Policies to encourage Part D's low-income subsidy (LIS) beneficiaries to use preferred drugs over nonpreferred

ones—largely aimed at reallocating use among brand drugs—should be careful to preserve the basic incentive to use generics instead of brands when possible.

The second study looked at the effects of eliminating copayments for generics, a popular strategy for promoting the use of generics over expensive brand medications (Stuart et al. 2017). The study was unusual for two reasons: (1) It looked specifically at Part D enrollees who received the LIS (researchers typically exclude these beneficiaries from studies on the effects of differential cost sharing since the LIS covers most of their cost sharing), and (2) the treatment and control groups were randomly assigned. The study examined LIS beneficiaries who were assigned to new Part D plans and compared those placed in plans that had free generics in two drug classes (oral antidiabetic drugs and statins) with those placed in plans that had copayments. The study did not find any significant differences in generic utilization between the two groups, suggesting that eliminating copayments on generic drugs may have relatively little effect on the LIS population. ■

class indication) while maintaining appropriate access to all or substantially all drugs in protected classes (Centers for Medicare & Medicaid Services 2019b, Kocot et al. 2019). However, due to concerns raised by stakeholders, CMS chose not to finalize its proposal.

The importance of adequate risk adjustment

Risk adjustment plays a vital role in a capitated payment system by counterbalancing plan incentives for selection and ensuring that plans receive adequate payment for covering high-cost individuals, such as Part D's LIS beneficiaries. Since capitated payments would play a larger role in a redesigned Part D benefit, ensuring that payments are properly risk adjusted is a key concern for policymakers.

It would be critically important for CMS to recalibrate the prescription drug hierarchical condition category (RxHCC) model if policymakers expanded the amount

of Part D drug spending covered by capitated payments. (See text box on Part D risk adjustment, pp. 148–149.) CMS has periodically recalibrated the model to account for the effects of the Affordable Care Act of 2010, which gradually required Part D plans to cover some drug spending in the coverage gap for beneficiaries without the LIS. These revisions appear to have been successful in ensuring that payment rates for those beneficiaries remain sufficient. The transition to the new benefit structure may increase CMS's administrative burden by requiring it to recalibrate the model more frequently than it would normally. However, CMS has substantial experience with recalibration, both for routine updates and in response to policy changes, and we believe that the agency would be able to recalibrate the model to ensure adequate payments to plans.

The structure of the RxHCC model should make it feasible for CMS to recalibrate the model to account

Would Part D's risk adjusters disadvantage plans that enroll a higher share of low-income subsidy beneficiaries?

In Part D, CMS uses the prescription drug hierarchical condition category (RxHCC) model to adjust payments to reflect the health status of each plan's enrollees. The RxHCC model assigns each demographic characteristic and medical diagnosis a weight that represents its expected impact on an enrollee's overall costs. Between 2006 and 2010, CMS applied an early version of the model that used the same risk adjusters for all Part D beneficiaries. In 2011, CMS began using a revised model that split beneficiaries into five groups: low-income subsidy (LIS) beneficiaries living in the community (divided into those under 65 and those 65 and older), beneficiaries without the LIS living in the community (divided into those under 65 and those 65 and older), and beneficiaries living in long-term care facilities. These groups have distinctive drug-spending profiles, so the revised model has a separate set of risk adjusters for each group. Under the revised model, the risk adjusters for LIS beneficiaries are generally larger than the adjusters for beneficiaries without the LIS, resulting in higher payments for LIS beneficiaries.¹⁸

Although LIS beneficiaries have higher drug costs and plan sponsors believe it is more difficult to manage their drug utilization, the sponsors and actuaries we interviewed all said that the revised RxHCC model had improved payment rates for LIS beneficiaries and that payments for this population are now generally adequate.

The recommended reforms would result in higher capitated payments for all enrollees, with a larger impact—in dollar terms—for LIS beneficiaries. However, given the structure of the RxHCC model, we contend that CMS would be able to recalibrate the model to ensure adequate *overall* payment rates for both sets of enrollees. One concern is that, because risk adjustment models tend to underpredict very high spending and overpredict very low spending, plans that enroll a relatively high share of high-cost beneficiaries could be disadvantaged.¹⁹ The Commission is particularly concerned about smaller plan sponsors that enroll a higher share of LIS beneficiaries.

To examine whether plan sponsors with a higher share of LIS beneficiaries are likely to be disadvantaged as a result of inadequate risk adjustment, we used 2018 claims data to compare variation in Part D's gross drug spending for LIS and other populations. We measured relative variation using the coefficient of variation (CV)—the standard deviation of individuals' annual spending divided by mean spending. A higher CV means there is more variation relative to the average. We found that although LIS enrollees have more than twice the average spending of enrollees without the LIS, relative variation in LIS spending is lower. In 2018, mean drug spending for LIS beneficiaries was \$6,371 compared with \$2,740 for other Part D beneficiaries (Table 5-9). However, the CV for LIS beneficiaries (280 percent) was considerably lower than for beneficiaries without the LIS (417 percent).

This difference in CVs reflects distinct patterns of prescription use and spending for these two populations. The majority of beneficiaries without the LIS used primarily low-cost generics and had relatively low spending. However, a relatively small share of these beneficiaries (3 percent in 2018) incurred spending high enough to reach the out-of-pocket (OOP) threshold. LIS beneficiaries, on the other hand, tended to have higher spending and were more likely to reach the OOP threshold: 19 percent did so in 2018.

To evaluate the potential effects of recalibration, it is useful to consider separately the two elements of higher liability that plans would incur under a restructured Part D benefit—more coverage-gap spending and catastrophic spending. We repeated our CV analysis on Part D claims but separately evaluated beneficiaries' spending below and above the OOP threshold. For LIS enrollees, average spending below the OOP threshold was \$3,037, and variation around that mean was relatively low: 99 percent (Table 5-9). By comparison, enrollees without the LIS had lower average spending below the threshold (\$1,909) but nearly twice as much relative variation around their mean (195 percent). This contrast suggests that as sponsors consider the additional liability that their plans would incur below

(continued next page)

Would Part D's risk adjusters disadvantage plans that enroll a higher share of low-income subsidy beneficiaries? (cont.)

the OOP threshold (including in the coverage gap), spending for LIS enrollees may be more predictable than spending for other enrollees. Likewise, as CMS recalibrates its risk adjusters for LIS enrollees, the agency's RxHCC model will have relatively less variation to explain below the OOP threshold than its models for other enrollees.

By comparison, catastrophic spending (spending above the OOP threshold) is less predictable than coverage-gap spending because the extreme values are influenced more heavily by use of high-priced drug and biologic treatments for less prevalent conditions, such as cancer and rheumatoid arthritis. For LIS enrollees (including those with no drug spending as well as individuals well above the OOP threshold), catastrophic spending averaged \$3,306 and varied widely (a CV of 506 percent) (Table 5-9). By comparison, average catastrophic spending for the other Part D enrollees was much lower (\$832). However, the relative variation

around that average was more than twice as large (1,169 percent). This suggests a recalibrated risk adjustment model is more likely to underpredict very high spending incurred by beneficiaries without the LIS than beneficiaries with the LIS.

In our analysis of claims data, we found that many LIS beneficiaries reach the catastrophic phase of the benefit using medications for chronic or more prevalent conditions (Medicare Payment Advisory Commission 2016). Beneficiaries without the LIS have more extreme spending than do LIS enrollees. In 2018, of the beneficiaries who reached the OOP threshold and did not receive the LIS, 10 percent incurred more than \$84,753 in gross Part D spending. Less than 5 percent of LIS beneficiaries who reached the OOP threshold reached that level of spending (data not shown), and the threshold for reaching the top 10 percent ranked by spending was \$44,780 (Table 5-9). ■

**TABLE
5-9**

Spending varied more for beneficiaries without the LIS than for LIS beneficiaries, 2018

	Beneficiaries without LIS		Beneficiaries with LIS	
	Mean	Coefficient of variation	Mean	Coefficient of variation
All Part D beneficiaries				
Annual spending per person	\$2,740	417%	\$6,371	280%
Spending below the OOP threshold	1,909	195%	3,037	99%
Spending above the OOP threshold	832	1,169%	3,306	506%
Distribution of spending for beneficiaries who reach the OOP threshold				
Mean	\$34,314		\$23,215	
Median	16,925		14,159	
90th percentile	84,753		44,780	

Note: LIS (low-income subsidy), OOP (out-of-pocket). Spending reflects prices paid at the pharmacy (gross spending) before postsale rebates and discounts. The coefficient of variation is the standard deviation of annual spending per person divided by the mean. Enrollees were included in this analysis if they were enrolled in Part D for the full benefit year. Values include enrollees who had no claims.

Source: MedPAC analysis of Part D's prescription drug event data.

for the disproportionate impact that the reform package would have on the average capitated payments for LIS beneficiaries. The key feature that makes this possible is the use of separate risk adjusters for LIS beneficiaries versus the other Part D beneficiaries. When CMS calculates these adjusters, it implicitly accounts for any differences in the average costs of the two populations. For example, under the illustrative example shown in Table 5-6 (p. 139), recalibrated risk adjusters would ensure that average capitated payments for LIS beneficiaries increased from \$139 to \$289, while payments for the other Part D beneficiaries would increase from \$87 to \$130.

However, it is important to note that the RxHCC model is not designed to predict costs for individual beneficiaries; it aims instead to predict costs for groups of beneficiaries, like the enrollees in a health plan. As a result, while we believe that the RxHCC model could be recalibrated to provide an adequate overall level of risk adjustment for plans that serve LIS beneficiaries, the recalibrated model might nonetheless underestimate costs for certain types of beneficiaries, such as those who use very high-cost drugs. These high-cost outliers might pose a greater risk for regional PDPs and MA-PDs because, compared with large plans offered by national sponsors (for which the effects of high-cost outliers are more likely to average out), they typically have lower enrollment and thus less ability to absorb losses. For example, some regional sponsors have little or no presence in other lines of business, such as commercial coverage or Medicaid managed care, that could be used to offset unexpected Part D losses, and regional sponsors that are nonprofit organizations may have lower capital reserves.

Because CMS estimates RxHCCs using past Part D claims, the model is not intended to adjust immediately for entries of new high-priced drugs. As a result, if those new entries are not anticipated by plan sponsors, and therefore are not reflected in their bids, plan sponsors could experience costs that exceed their risk-adjusted payments (and premiums). When new therapies for hepatitis C entered the market, CMS manually modified certain RxHCCs to reflect high-priced treatments until Part D claims data for the products became available to recalibrate the risk adjustment model.

While cases like hepatitis C drugs are not likely to occur frequently, CMS may want to investigate whether the RxHCC model could incorporate major therapeutic innovations more quickly to prevent large and systematic

underpayments or overpayments for a particular condition. At the same time, if Medicare were to base plan payments on risk-adjusted amounts that predict actual spending too closely, the result would differ little from using a system of cost-based reimbursement rather than one of prospective payment.

Transitional changes to risk corridors

The recommended reforms would require plan sponsors to bear more financial risk by expanding the use of capitated payments and reducing the use of cost-based payments for the LICs and reinsurance. We anticipate that, under a restructured Part D, some plans could experience spending patterns that are more variable than their historical experience based on the current plan liability.

Some stakeholders we interviewed suggest that drug spending is inherently more difficult to predict than medical spending because of uncertainties about when new drugs will enter the market, their launch prices, and the extent to which new therapies will be prescribed. Because high-priced orphan and specialty drugs have made up larger shares of new medications in the development pipeline, most interviewees thought that drug spending had grown more difficult to predict over time. In an earlier analysis, we found that between 2008 and 2012, variation in Medicare beneficiaries' drug spending had grown, but was roughly comparable with variation in medical spending by the end of the period (Medicare Payment Advisory Commission 2015). In an updated analysis, we found that variation in drug spending now exceeds that of FFS medical spending. However, variation was driven mostly by predictable spending; nearly 80 percent of spending in the catastrophic phase was attributable to beneficiaries who had catastrophic spending in the previous year, meaning that unexpected costs accounted for only about 20 percent of total catastrophic costs.

It would be very important for CMS to recalibrate the RxHCC model to ensure that plans are compensated appropriately and to discourage plan sponsors from engaging in risk selection. However, given the higher insurance risk associated with spending in the catastrophic phase of the benefit, the recalibration of the RxHCC model could be insufficient to achieve those goals, at least during a transition period. Further, plan sponsors with smaller membership size could be less able to absorb the effects of an unexpected change in the pharmaceutical market (e.g., the unanticipated launch of an expensive new medication) compared with their larger counterparts.

Part D's risk corridors limit (but do not cap) a plan's overall losses across all its enrollees when actual spending for basic benefits is higher than predicted spending. (Since Part D's risk corridors are symmetric, they also limit a plan's unanticipated profits.) In contrast to Medicare's individual reinsurance that protects plans against unexpectedly high costs incurred by individual enrollees, risk corridors provide a cushion at the plan level in the event of unforeseen high drug spending.

Currently, plan sponsors are at full financial risk if actual benefit spending is within the range of 95 percent to 105 percent of the plan's bid. (That is, a plan is fully at risk for spending up to 5 percent above its bid (losses) or 5 percent below (profits).) If actual benefit spending is either between 105 percent and 110 percent of the bid or between 90 percent and 95 percent of the bid, Medicare splits the difference with the plan sponsor between the bid and actual benefit spending 50–50. Beyond 110 percent or below 90 percent, Medicare covers 80 percent of excess benefit costs (or recoups excess profits).

If plan sponsors are to assume a greater share of spending in the catastrophic phase of the benefit, policymakers could consider making the risk corridors more generous to provide greater protection. For example, policymakers could narrow the risk corridors so that plans are fully at risk for less than 5 percent above or below their bids. Because plan bids would be higher with a restructured benefit than with the current benefit structure, a narrower corridor would help to keep the potential losses (or profits) at a level closer to what plans face today. Policymakers could also consider different risk-sharing percentages in the corridors, including greater aggregate stop-loss protection, which could be particularly valuable for smaller plans and plan sponsors that do not have the scale to self-reinsure.

Recommendations for a restructured Part D benefit

Three interrelated recommendations for restructuring Part D have evolved from the Commission's 2016 recommendations to provide a package of reforms. Under our first recommendation, the Congress would change the benefit's design to introduce an OOP cap for all Part D beneficiaries and would reallocate the financial risk of benefit spending among plan sponsors, pharmaceutical

manufacturers, and the Medicare program. In the second recommendation, the Congress would make concurrent changes that would give plan sponsors greater flexibility to manage formularies and would tighten Part D's risk corridors during a transition period to the new benefit design. Under the third recommendation, CMS would facilitate greater formulary flexibility and ensure that Part D's risk adjustment system compensates plans for the higher benefit liability required under the new benefit design.

RECOMMENDATION 5 - 1

The Congress should make the following changes to the Part D prescription drug benefit:

- **Below the out-of-pocket threshold:**
 - **Eliminate the initial coverage limit.**
 - **Eliminate the coverage-gap discount program.**
- **Above the out-of-pocket threshold:**
 - **Eliminate enrollee cost sharing.**
 - **Transition Medicare's reinsurance subsidy from 80 percent to 20 percent.**
 - **Require pharmaceutical manufacturers to provide a discount equal to no less than 30 percent of the negotiated price for brand drugs, biologics, biosimilars, and high-cost generic drugs.**

RATIONALE 5 - 1

At the start of the Part D program, plan sponsors had strong incentives to manage their enrollees' drug spending because most of their revenues took the form of fixed-dollar premiums and capitated payments from Medicare. Over time, changes in law and in spending patterns have significantly reduced plans' financial liability for benefits and eroded their incentives to manage spending. Plans' small liability in the coverage gap and catastrophic phases of the benefit have led to incentives for Part D sponsors to place certain high-price, high-rebate products on their formularies. Some manufacturers find that increasing their prices allows them to offer larger rebates than their competitors and gain favorable formulary placement while paying comparatively small coverage-gap discounts. In other words, manufacturers do not bear much of the effects of their price increases as directly as they would if the discount applied in the catastrophic phase of the benefit. Meanwhile, beneficiaries pay coinsurance based on high list prices for some of those drugs, potentially reaching Part D's OOP threshold more quickly than if the

plan sponsor had instead selected lower priced therapies for their formulary. The coverage-gap discount also distorts beneficiary and plan incentives because it makes the brand-name drugs cheaper relative to generic drugs. Beneficiaries who reach the OOP threshold pay 5 percent coinsurance with no upper limit. Because Medicare subsidizes nearly 75 percent of basic benefits, the financial burden on taxpayers is likely higher than it would be if policymakers restored Part D to its original approach of using more risk-based payments with stronger incentives for plans to manage benefit spending.

The discount in the catastrophic phase could be set at a higher rate to offset other costs of the restructured benefit. Alternatively, policymakers could choose to pay for the restructured benefit through higher enrollee premiums, higher Medicare program spending, or both. The Commission chose a manufacturer discount rate of at least 30 percent to include manufacturers among the stakeholders that would bear strong direct effects of drug price increases. A 30 percent discount would also help offset what would otherwise be increases in enrollee premiums and Medicare program spending resulting from Part D's new benefit structure.

As part of our recommendation, the reduction in reinsurance payments and increase in plan liability for catastrophic spending would be phased in during a transition period. (The other elements of the new benefit structure—eliminating the coverage gap, replacing the coverage-gap discount program with a new discount program in the catastrophic phase, and adding an annual cap on beneficiary OOP costs—could be implemented without a transition.) We have suggested a transition period of four years, but policymakers could consider a shorter or longer period. A longer transition would give plans more time to adjust to the new benefit structure and allow policymakers to respond to any unexpected outcomes before the new structure is fully phased in. However, a longer transition would also leave some of the current system's misaligned incentives in place longer and potentially inhibit the entrance into the market of new Part D sponsors.

RECOMMENDATION 5-2

Concurrent with our recommended changes to the benefit design, the Congress should:

- **Establish a higher copayment amount under the low-income subsidy for nonpreferred and nonformulary drugs.**

- **Give plan sponsors greater flexibility to manage the use of drugs in the protected classes.**
- **Modify the program's risk corridors to reduce plans' aggregate risk during the transition to the new benefit structure.**

RATIONALE 5-2

The second recommendation would provide plan sponsors with stronger formulary tools with which to manage enrollees' drug spending and negotiate lower prices. It would complement the first recommendation in that the combination of greater incentives (more of Medicare's subsidy through capitated payments) and stronger tools (more formulary flexibility) could lead plan sponsors to manage overall drug spending more effectively.

Plan sponsors routinely use differential cost sharing to make lower cost drugs and biologics more attractive to enrollees. However, since maximum cost sharing for LIS enrollees is set by law and plans cannot modify those amounts, sponsors have limited ability to manage drug spending for this population. Current LIS copayments provide much weaker financial incentives to choose lower cost medications than those faced by other enrollees. In particular, LIS enrollees have no financial incentive to choose brand-name drugs on a preferred tier over an alternative on a nonpreferred tier or a nonformulary drug. Under this recommendation, plans would make LIS enrollees and their prescribers aware of preferred therapeutic options as well as the relevant LIS copayment amounts.

Under the existing protected-class policy, plan sponsors must include all drugs in six therapeutic classes on their formulary. Even though plan sponsors may place utilization management requirements on protected-class drugs, their inability to exclude products from a plan's formulary prevents sponsors from using competitive pressure among alternative drug therapies to negotiate for manufacturer rebates. In turn, plan sponsors report that manufacturers offer fewer rebates on brand-name drugs in protected classes, and when they are available, the rebates are lower, on average (Johnson et al. 2018). The Commission has also noted higher than average increases in list prices of single-source drugs within some of the protected classes (Medicare Payment Advisory Commission 2020b).

By modifying Part D's current risk corridors, Medicare could place temporary aggregate limits on the amount of risk plans bear as they transition to the restructured benefit.

RECOMMENDATION 5-3

Concurrent with our recommended changes to the benefit design, the Secretary should:

- **Allow plans to establish preferred and nonpreferred tiers for specialty-tier drugs.**
- **Recalibrate Part D's risk adjusters to reflect the higher benefit liability that plans bear under the new benefit structure.**

RATIONALE 5-3

The third recommendation consists of complementary actions that the Commission believes the Secretary should take in coordination with the changes in law described in the first two recommendations. Given the rapid growth in the introduction of and Part D spending for specialty-tier drugs, plan sponsors need new tools with which to manage those therapies. By allowing plans to set differential cost-sharing requirements between competing specialty products, plan sponsors may be able to encourage their enrollees to use lower priced therapies. Plan sponsors may also gain more leverage in negotiating rebates with manufacturers.

Under a restructured benefit, Part D plans would receive less reinsurance from Medicare and higher capitated payments. CMS would recalibrate its RxHCC risk adjustment model to reflect the new higher average plan liability.

IMPLICATIONS 5-1, 5-2, AND 5-3

Spending

- The Congressional Budget Office estimates that the combination of the Commission's three recommendations would lead to one-year program savings of greater than \$2 billion relative to baseline spending and savings of greater than \$10 billion over five years. Separate estimates for each recommendation are not available.

Beneficiaries

- The restructured benefit would be a simpler design than Part D's current benefit in that cost sharing would be more predictable for beneficiaries, who would no longer experience three different structures

of cost sharing: one before they reach the initial coverage limit, one in the coverage gap, and one in the catastrophic phase.

- A new annual cap on OOP costs would lower cost sharing for enrollees who have high drug spending and would provide more complete financial protection for all enrollees. For beneficiaries who do not receive the LIS, the annual cap on OOP would eliminate cost barriers and improve access to medications, which in turn could increase the use of medications. The increase may enhance the health benefit of pharmaceutical care for some beneficiaries, while increasing polypharmacy could result in adverse health effects for others.
- Introducing differential cost sharing between plans' preferred and nonpreferred drugs would give LIS beneficiaries stronger financial incentives to use lower cost drugs. If beneficiaries switched to preferred therapies, those individuals would see no change in OOP spending. However, if a nonpreferred therapy was medically necessary, the beneficiary would have to pay the modestly higher copayment or pursue a tiering exception to obtain the nonpreferred therapy at a preferred (lower) copayment. Because the higher nonpreferred copayment would also apply to drugs not on a plan's formulary (nonformulary drugs), a beneficiary who obtained a nonformulary drug through the plan's exceptions process would also pay somewhat higher cost sharing than under current law. In those situations, we expect that plan sponsors would make LIS enrollees and their prescribers aware of the tier placement of the prescribed drug, preferred alternatives, and relevant LIS copay amounts.
- If plan sponsors offered a benefit with two specialty tiers (preferred and nonpreferred), beneficiaries who chose medications on the preferred specialty tier would benefit from lower cost sharing. If a nonpreferred specialty-tier product was medically necessary, the beneficiary would have to pay the higher cost sharing or pursue a tiering exception to obtain the nonpreferred product at the lower cost sharing that applied to the preferred specialty tier (or, in the case of an LIS beneficiary, the lower copayment set in law for preferred drugs).
- Part D has multiple beneficiary protections that would help ensure that all enrollees had continued access to clinically appropriate medications. One

such protection relates to CMS’s formulary review that ensures broad coverage of medications. Plans must include at least two distinct drugs per class on their formularies. Beneficiaries would face somewhat higher cost sharing only if they and their prescriber selected a nonpreferred product over the preferred therapy. Under this policy change, beneficiaries would have access to a tiering exceptions process that would allow them to obtain the nonpreferred-tier drug at the lower, preferred cost sharing when the use of a nonpreferred-tier drug is medically necessary.

- The effects of our recommendations on enrollee premiums would depend on multiple factors and would vary by plan. On the one hand, plan sponsors would have more formulary tools and stronger incentives to manage their enrollees’ spending. That, in turn, would tend to lower benefit costs and enrollee premiums. However, the increased generosity of the Part D benefit would tend to put upward pressure on costs and premiums. If the change in plan formularies or benefit structure resulted in more requests for exceptions and appeals cases, that could result in higher administrative costs, a portion of which would be reflected in enrollee premiums. Eliminating the coverage gap and beneficiary cost sharing in the catastrophic phase would increase the costs of Part D’s basic benefit, which in turn could lead to higher enrollee premiums. However, a new manufacturer discount of 30 percent or more of catastrophic spending could offset most if not all of those higher benefit costs. If, under this policy change, enrollee premiums for basic benefits increased, a small share of beneficiaries could choose not to enroll in Part D. However, given that Medicare would continue to subsidize about 75 percent of the costs of the basic Part D benefit, we expect that most enrollees would remain in the program.

Plans

- Plan sponsors would be responsible for a larger share of catastrophic benefits than they are today, and Medicare’s reinsurance payments would be smaller. Because this recommendation would reduce Medicare’s reinsurance and increase plans’ capitated payments, plan sponsors would bear more insurance risk for their enrollees’ benefit spending. In general, we expect this approach would give plan sponsors stronger incentives to manage enrollees’ spending and reduce incentives for sponsors to put

high-price, high-rebate drugs on their formularies. If the recommendations are implemented, the Commission intends to monitor the aggregate amount of manufacturer rebates to observe whether the policy changes achieve their intended effect of reducing the misaligned incentives with respect to postsale rebates.

- Plan bids would be higher under the restructured benefit, and plan sponsors would receive higher capitated direct subsidy payments from Medicare. CMS would recalibrate Part D’s risk adjustment system to reflect the predictably higher benefit spending in Medicare’s capitated payments. Because of changes in law to close the coverage gap, CMS has experience updating its risk adjustment model on a regular basis. Under Part D’s risk adjustment model, with separate risk adjusters for LIS beneficiaries, CMS would be able to recalibrate the model to account for the disproportionate impact that the reform package would have on the average capitated payments for LIS beneficiaries. In addition, a transition period would allow CMS to monitor the adequacy of risk-adjusted payments and any impact on plan sponsors’ incentives for risk selection.
- Under the restructured benefit, plan sponsors would have more formulary tools to manage benefit spending, which in turn could lower basic benefit costs and enrollee premiums. By changing the LIS copay structure to add a new higher copayment for medications placed on a nonpreferred tier or for nonformulary drugs, plan sponsors would have an important new tool for managing spending for LIS enrollees. A new higher LIS copayment amount for nonpreferred or nonformulary drugs would also give plan sponsors greater leverage with manufacturers.
- With greater flexibility to manage drugs in the protected classes, plan sponsors would have more leverage to negotiate price concessions for protected-class drugs for which competition exists among drug manufacturers. Allowing plan sponsors to use two specialty tiers (preferred and nonpreferred) would provide a new tool to encourage the use of preferred therapies on a specialty tier, while at the same time giving sponsors leverage in their negotiations for rebates among manufacturers of drugs and biologics with high prices. This ability to structure competition among specialty products would allow plan sponsors to encourage the use of biosimilars (when they become available) and could facilitate

further development of biosimilar products. At the same time, if more beneficiaries sought exceptions for nonpreferred or nonformulary drugs, plans could have higher administrative costs associated with their exceptions and appeals process. That, in turn, could put upward pressure on plan bids and premiums.

- The new 30 percent manufacturer discount in the catastrophic phase could help limit growth in drug prices and offset Part D's basic benefit costs. If policymakers structured the discount rate so that it was indexed to growth in some benchmark measure of price inflation (such as in average Part D spending) and could potentially increase in later years, policymakers could consider lowering Medicare's reinsurance by the same amount as each incremental increase in the discount rate. If the discount rate increases led instead to a reduction in plan liability, that reduction could weaken plan incentives to manage spending.
- Replacing the coverage-gap discount program with a new manufacturer discount in the catastrophic phase would have a disproportionate impact on EGWPs. If EGWP sponsors continued to provide supplemental benefits that prevented or delayed enrollees from reaching the catastrophic phase of the benefit, they would receive fewer manufacturer discounts than they do now. At the same time, because CMS would need to go through the rule-making process to implement the restructured benefit, we expect employers would have time to adjust their benefit offerings or switch to providing the prescription drug benefit through a plan that is eligible for the retiree drug subsidy before facing the full financial impact of the reforms.
- The Commission believes it is important to transition to the new benefit structure over a period of several years partly out of concern for the stability of smaller MA-PDs that serve larger numbers of LIS enrollees. The reduction in reinsurance payments and increase in plan liability for catastrophic spending would be phased in so that plan sponsors could adjust to the new distribution of risk. (The other elements of the new benefit structure—eliminating the coverage gap, replacing the coverage-gap discount program with a new discount program in the catastrophic phase, and adding an annual cap on beneficiary OOP costs—would be implemented without a transition.) During the transition period, CMS would be able to monitor and evaluate plan sponsors' progress at

using new flexibilities for managing benefit spending while still providing beneficiaries with appropriate access to medicines. A transition period would give policymakers time to identify and address any unexpected outcomes with the implementation of the new benefit.

- We have suggested a transition period of four years, but policymakers could consider a shorter or longer period. A longer transition would give plans more time to adjust to the new benefit structure and would allow policymakers to respond to any unexpected outcomes before the new structure was fully phased in. However, it would also leave some of the current system's misaligned incentives in place longer and potentially inhibit the entrance into the market of new Part D sponsors. Modifying Part D's risk corridors would provide greater financial protection during the transition to a new benefit structure. The enhanced protection could take the form of a tighter range around plan bids in which plans would be at full risk for their benefit spending, changes to the shares of gains or losses borne by Medicare and plans, or both. The modifications would be available to all plan sponsors. However, such measures would be especially important to smaller sponsors of regional MA-PDs that have larger proportions of LIS enrollees.

Pharmaceutical manufacturers

- Restructuring Part D's benefit to remove the brand manufacturer discount in the coverage gap and establishing a new manufacturer discount in the catastrophic phase would affect individual pharmaceutical manufacturers differently, depending on the products they make. Manufacturers of relatively lower priced products that now pay a sizable share of the coverage-gap discounts might see higher revenues because they would no longer need to discount their products in the coverage gap. Producers of higher priced products would pay proportionately more of the new discount.
- The new manufacturer discount in the catastrophic phase could potentially restrain manufacturers' incentives to increase drug prices. The discount could be more effective at restraining price increases if it were structured so that the discount rate increased if the average price of the drugs subject to the discount increased faster than a benchmark (such as

average Part D spending). However, the effects on manufacturers' pricing decisions would likely vary, depending on the manufacturer's Medicare market share and the degree of competition among therapeutic alternatives. There is also uncertainty as to whether the policy change would restrain or worsen the growth in launch prices of new therapies.

- New formulary tools would allow plan sponsors to bargain harder for higher rebates or reduce enrollees' use of products that offered low or no rebates through the use of nonpreferred tiers. For certain protected-class drugs, there could be products that would no longer be included on plans' formularies. As a result, some manufacturers could experience lower Part D revenues or diminished ability to raise prices of their products.
- A 30 percent manufacturer discount on catastrophic spending would likely constrain the profitability of

new specialty drugs and potentially reduce incentives to invest in the research and development (R&D) of such products. Two key issues to consider are the magnitude of potential investment reductions in pharmaceutical R&D that may result from the policy change and the value of drugs that subsequently would not be developed (Ginsburg and Leiberhan 2020). Some stakeholders contend that more investment resources are needed to pursue breakthrough drugs. Others believe that the current pool of resources already permits some projects to be funded that are of limited value. Because the new discount is more likely to apply to high-priced drugs and biologics, the policy change could steer investments in pharmaceutical R&D away from such products and toward drugs to address complicated aspects of more prevalent conditions (Gottlieb and Ippolito 2019). ■

Endnotes

- 1 The amount of gross prescription drug spending needed to reach Part D's OOP threshold varies by individual, depending on LIS status and the mix of brand and generic prescriptions an enrollee fills.
- 2 In 2020, 150 percent of the federal poverty guideline was \$19,140 for an individual or \$25,860 for a couple.
- 3 This figure is based on a volume-weighted Part D price index constructed by Acumen LLC, using prices paid at the point of sale (POS). The indexes do not reflect postsale rebates or discounts from manufacturers and pharmacies. POS prices are the relevant metric for determining when a beneficiary has reached the OOP threshold.
- 4 The figure (\$13 billion) for low-income cost-sharing subsidies for prescriptions filled during the coverage gap is an estimate that reflects our internal algorithm to apportion claims that straddle multiple phases of the benefit.
- 5 Under law, Medigap policies may not cover Part D cost sharing, but they do cover cost sharing for Part B drugs.
- 6 Like PDPs, MA-PDs can offer either basic coverage or enhanced coverage. Almost all beneficiaries in traditional MA-PDs (about 95 percent) are in plans that offer enhanced coverage, while most beneficiaries in D-SNPs (about 80 percent) are in plans that offer basic coverage.
- 7 Medicare also has other types of health plans that include Part D coverage but are not classified as MA-PDs because they operate outside of the MA program. Two types of plans—Medicare-Medicaid Plans and the Program of All-Inclusive Care for the Elderly—are made up almost entirely of LIS beneficiaries, but in 2019 their share of the overall LIS population was only 3 percent.
- 8 The PBM market is highly concentrated, and the three largest PBMs are owned by major insurers that also compete with smaller plans in some geographic markets: CVS Caremark (owned by CVS Health, which owns Aetna), Express Scripts (owned by Cigna), and OptumRx (owned by UnitedHealth Group). Given the dominant position of the large PBMs and the importance of obtaining postsale rebates under Part D's current structure, new plan sponsors could have difficulty entering the Part D market because they face greater uncertainty about their plans' enrollment and manufacturers would be less likely to negotiate larger rebates with them. Going forward, policymakers could consider other approaches to ensure that new plan sponsors with innovative approaches to service delivery can enter the Part D market.
- 9 Under the RDS, Medicare provides a tax-free subsidy to an employer for 28 percent of each eligible retiree's drug costs that fall within a specified range of spending.
- 10 In 2018, CMS finalized a number of regulatory changes in Part D and proposed other steps to allow plan sponsors to use tools already available for managing pharmacy benefits in commercial populations. Some of those policies are consistent with the Commission's 2016 recommendations.
- 11 A few drug categories are excluded by statute, such as agents used for weight loss or gain, to promote fertility, for cosmetic purposes or hair growth, or for symptomatic relief of cough and colds.
- 12 Although plan sponsors tend to use coinsurance for nonpreferred and specialty tiers, one can get a sense of their magnitude in dollar terms because CMS prohibits plans from charging more than \$100 for nonpreferred drugs and limits specialty tiers to drugs that cost more than \$670, which means that the median coinsurance of 25 percent on a specialty tier drug is at least \$167.50 (Centers for Medicare & Medicaid Services 2019a).
- 13 For example, CMS could consider granting exceptions from the requirement for plans to put two drugs per class (or type) on their formulary if over-the-counter alternatives were available or if one of the drugs that plans would normally have to cover was an extended-release version of an existing product. In 2018, a CMS proposed rule would have permitted plans to exclude extended-release versions of protected-class drugs from their formularies, but the policy changes were not finalized.
- 14 Most Part D plans have a specialty tier, but not all plans place every high-cost specialty drug on a specialty tier. Cost-sharing amounts on specialty tiers range from 25 percent to 33 percent of pharmacy (point-of-sale) prices. The industry does not have one consistent definition of specialty drugs, but these drugs tend to be characterized as high cost and are used to treat rare conditions, require special handling, use a limited distribution network, or require ongoing clinical assessment (Doshi et al. 2016).
- 15 The Congressional Budget Office found that, in 2015, manufacturer rebates averaged 10.5 percent for specialty drugs compared with 28.4 percent for nonspecialty brand-name drugs (Congressional Budget Office 2019).
- 16 For example, differential cost sharing would not apply to beneficiaries who receive Medicaid nursing home care. These beneficiaries are typically required to use all their income—

except for a very modest personal need allowance (often \$30 per month) and a spousal allowance, if applicable—to help pay for their care, which is why the LIS fully covers their cost sharing.

- 17 CMS’s proposal would have established additional exceptions to allow Part D sponsors to (1) implement broader use of prior authorization and step therapy requirements for protected-class drugs, including to determine use for protected-class indications; (2) exclude a protected-class drug from a formulary if the drug was a new formulation of an existing single-source drug or biological product, regardless of whether the older formulation remained on the market; and (3) exclude a protected-class drug from a formulary if the price of the drug increased beyond a certain threshold over a specified period. (These exceptions from the protected-class policy would not have superseded other Part D formulary requirements, such as plan sponsors’ obligation to cover two distinct drugs in each drug class.)
- 18 For example, the base payment rate in 2020 for a 73-year-old female who lives in the community is \$383 for an LIS beneficiary and \$247 for a beneficiary without the LIS. In addition, the added payments based on diagnosis codes are often higher for LIS beneficiaries: If the same 73-year-old also has diabetes without complications, Medicare will pay an additional \$332 for an LIS beneficiary and \$280 for a beneficiary without the LIS.
- 19 However, the Commission has consistently found that, under the MA program’s similar model for risk-adjusting payments (the CMS–hierarchical condition category, or CMS–HCC, model), special needs plans, which serve certain types of high-cost beneficiaries, have higher profits than MA plans that serve a broad range of beneficiaries (Government Accountability Office 2013, Medicare Payment Advisory Commission 2020b).

References

- American Medical Association. 2019. Industry checkup: Measuring progress in improving prior authorization. <https://www.ama-assn.org/system/files/2019-03/prior-auth-survey.pdf>.
- American Medical Association–convened workgroup of 17 state and specialty medical societies. 2019. Prior authorization and utilization management reform principles. <https://www.ama-assn.org/practice-management/sustainability/prior-authorization-reform-initiatives>.
- Bachler, R., N. Johnson, and M. Hamachek. 2019. *Observations on the employer stop-loss market: 2019 survey*. Seattle, WA: Milliman.
- BenMedica. 2019. Physician insights on the limitations of formulary and real-time information. <https://www.benmedica.com/insights>.
- Boards of Trustees, Federal Hospital Insurance and Federal Supplementary Medical Insurance Trust Funds. 2019. *2019 annual report of the Boards of Trustees of the Federal Hospital Insurance and Federal Supplementary Medical Insurance Trust Funds*. Washington, DC: Boards of Trustees.
- Centers for Medicare & Medicaid Services, Department of Health and Human Services. 2019a. Announcement of calendar year (CY) 2020 Medicare Advantage capitation rates and Medicare Advantage and Part D payment policies and final call letter. April 1.
- Centers for Medicare & Medicaid Services, Department of Health and Human Services. 2019b. Modernizing Part D and Medicare Advantage and the Medicare prescription drug benefit programs to lower drug prices and reduce out-of-pocket expenses. Final rule. *Federal Register* 84, no. 100 (May 23): 23832–23884.
- Centers for Medicare & Medicaid Services, Department of Health and Human Services. 2018a. Announcement of calendar year (CY) 2019 Medicare Advantage capitation rates and Medicare Advantage and Part D payment policies and final call letter. April 2. <https://www.cms.gov/Medicare/Health-Plans/MedicareAdvSpecRateStats/Downloads/Announcement2019.pdf>.
- Centers for Medicare & Medicaid Services, Department of Health and Human Services. 2018b. Modernizing Part D and Medicare Advantage to lower drug prices and reduce out-of-pocket expenses. Proposed rule. *Federal Register* 83, no. 231 (November 30): 62153–62201.
- Centers for Medicare & Medicaid Services, Department of Health and Human Services. 2017. Medicare program; contract year 2019 policy and technical changes to the Medicare Advantage, Medicare cost plan, Medicare fee-for-service, the Medicare prescription drug benefit programs, and the PACE program. Proposed rule. *Federal Register* 82, no. 227 (November 28): 56336–56527.
- Congressional Budget Office. 2019. *Prices for and spending on specialty drugs in Medicare Part D and Medicaid*. Washington, DC: CBO.
- CoverMyMeds. 2020. Medication access report. <https://www.covermymeds.com/main/medication-access-report/>.
- Cubanski, J., and A. Damico. 2019. *Medicare Part D: A first look at prescription drug plans in 2020*. Issue brief. Washington, DC: Kaiser Family Foundation.
- Doshi, J. A., P. Li, V. P. Ladage, et al. 2016. Impact of cost sharing on specialty drug utilization and outcomes: A review of the evidence and future directions. *American Journal of Managed Care* 22, no. 3 (March): 188–197.
- Dusetzina, S. B., S. Jazowski, A. Cole, et al. 2019. Sending the wrong price signal: Why do some brand-name drugs cost Medicare beneficiaries less than generics? *Health Affairs* 38, no. 7 (July): 1188–1194.
- Fein, A. 2020. Why Part D plans prefer high list price drugs that raise costs for seniors. *Drug Channels* blog. January 22. <https://www.drugchannels.net/2020/01/why-part-d-plans-prefer-high-list-price.html>.
- Galewitz, P. 2019. Doctors slow to adopt tech tools that might save patients money on drugs. *Kaiser Health News*, July 5. <https://www.kpbs.org/news/2019/jul/05/doctors-slow-to-adopt-tech-tools-that-might-save/>.
- Ginsburg, P. B., and S. M. Leiberman. 2020. *The Elijah E. Cummings Lower Drug Costs Now Act: How it would work, how it would affect prices, and what the challenges are*. Issue brief. Washington, DC: Commonwealth Fund.
- Goldman, D. P., G. F. Joyce, and Y. Zheng. 2007. Prescription drug cost sharing: Associations with medication and medical utilization and spending and health. *Journal of the American Medical Association* 298, no. 1 (July 4): 61–69.
- Gottlieb, S., and B. Ippolito. 2019. Evaluating the Senate Finance Committee proposal to restructure Medicare Part D. American Enterprise Institute blog. July 24. <https://www.aei.org/health-policy/evaluating-the-senate-finance-committee-proposal-to-restructure-medicare-part-d/>.

- Government Accountability Office. 2013. *Medicare Advantage: Substantial excess payments underscore need for CMS to improve accuracy of risk score adjustments*. Washington, DC: GAO.
- Hartman, M., A. B. Martin, J. Benson, et al. 2019. National health care spending in 2018: Growth driven by accelerations in Medicare and private insurance spending. *Health Affairs* 39, no. 1 (December 5).
- Hartung, D. M., M. J. Carlson, D. F. Kraemer, et al. 2008. Impact of a Medicaid copayment policy on prescription drug and health services utilization in a fee-for-service Medicaid population. *Medical Care* 46, no. 6 (June): 565–572.
- Johnson, N., C. Mills, and M. Kridgen. 2018. *Prescription drug rebates and Part D drug costs*. Milliman report prepared for America’s Health Insurance Plans. Seattle, WA: Milliman.
- Kaczmarek, S. 2015. Pharmacy manufacturer rebate negotiation strategies: A common ground for a common purpose. <https://www.milliman.com/en/insight/2015/pharmacy-manufacturer-rebate-negotiation-strategies-a-common-ground-for-a-common-purpose>.
- Kaiser Family Foundation. 2018. Medicaid benefits: Prescription drugs. <https://www.kff.org/medicaid/state-indicator/prescription-drugs/?currentTimeframe=0&sortModel=%7B%22colId%22:%22Location%22,%22sort%22:%22asc%22%7D>.
- Kocot, S. L., T. McCutcheon, and R. White. 2019. Protected class policy can promote both patient access and competition. *Health Affairs* blog. January 22. <https://www.healthaffairs.org/doi/10.1377/hblog20190118.805215/full/>.
- Lieberman, D. A., J. M. Polinski, N. K. Choudhry, et al. 2014. Unintended consequences of a Medicaid prescription copayment policy. *Medical Care* 52, no. 5 (May): 422–427.
- Medicaid and CHIP Payment and Access Commission. 2018. *Medicaid payment for outpatient prescription drugs*. Washington, DC: MACPAC.
- Medicare Payment Advisory Commission. 2020a. Comment letter on CMS’s proposed rule entitled, “Medicare and Medicaid Programs; Contract Year 2021 and 2022 Policy and Technical Changes to the Medicare Advantage Program, Medicare Prescription Drug Benefit Program, Medicaid Program, Medicare Cost Plan Program, and Programs of All-Inclusive Care for the Elderly. April 3.
- Medicare Payment Advisory Commission. 2020b. *Report to the Congress: Medicare payment policy*. Washington, DC: MedPAC.
- Medicare Payment Advisory Commission. 2019a. Comment letter on CMS’s notice of proposed rulemaking entitled “Modernizing Part D and Medicare Advantage to lower drug prices and reduce out-of-pocket expenses.” January 16.
- Medicare Payment Advisory Commission. 2019b. *A data book: Health care spending and the Medicare program*. Washington, DC: MedPAC.
- Medicare Payment Advisory Commission. 2019c. *Payment basics: Part D payment system*. Washington, DC: MedPAC.
- Medicare Payment Advisory Commission. 2019d. *Report to the Congress: Medicare and the health care delivery system*. Washington, DC: MedPAC.
- Medicare Payment Advisory Commission. 2019e. *Report to the Congress: Medicare payment policy*. Washington, DC: MedPAC.
- Medicare Payment Advisory Commission. 2017. *Report to the Congress: Medicare payment policy*. Washington, DC: MedPAC.
- Medicare Payment Advisory Commission. 2016. *Report to the Congress: Medicare and the health care delivery system*. Washington, DC: MedPAC.
- Medicare Payment Advisory Commission. 2015. *Report to the Congress: Medicare and the health care delivery system*. Washington, DC: MedPAC.
- Medicare Payment Advisory Commission. 2010. *A data book: Health care spending and the Medicare program*. Washington, DC: MedPAC.
- Office of Inspector General, Department of Health and Human Services. 2019. *Some Medicare Part D beneficiaries face avoidable extra steps that can delay or prevent access to prescribed drugs*. OEI–09–16–00411. Washington, DC: OIG.
- Pharmacy Benefit Management Institute. 2017. *Trends in drug benefit design*. Plano, TX: PBMI.
- Stuart, B., F. Hendrick, J. S. Dougherty, et al. 2017. Does the offer of free prescriptions increase generic prescribing? *American Journal of Managed Care* 23, no. 6 (June 1): e193–e201.
- SureScripts. 2018. National progress report. <https://surescripts.com/news-center/national-progress-report-2018/>.
- Walker, J., and C. Weaver. 2019. The \$9 billion upcharge: How insurers kept extra cash from Medicare. *Wall Street Journal*, January 4.

CHAPTER

6

**Separately payable drugs
in the hospital outpatient
prospective payment system**

Separately payable drugs in the hospital outpatient prospective payment system

Chapter summary

CMS has defined the unit of payment in the hospital outpatient prospective payment system (OPPS) as a primary service (the reason for the visit) coupled with the ancillary items provided with the primary service. That is, the OPPS typically packages the cost of ancillary items into the payment rate of the related primary service. This approach contrasts with a fee schedule in which each service (both primary and ancillary) has a separate payment. Combining a primary service and related ancillary items into a single payment unit encourages efficiency because the combination of inputs used to treat a patient determines whether the provider experiences a financial gain or loss. In this chapter, we consider an exception to this general policy in the OPPS: separately payable drugs. Although we are focusing on separately payable drugs, the issues we consider in the chapter have broader implications.

Although packaging ancillary items has the benefit of encouraging efficiency, not all ancillary items should be packaged. If the OPPS packaged ancillary items that are costly or infrequently provided with a particular primary service, the financial risk to hospitals could be excessive. By volume, the OPPS treats most drugs as packaged items. However, the OPPS provides payments for some relatively high-cost drugs that are separate from primary services. The OPPS has two distinct policies for paying for these drugs: pass-through drugs and separately payable non-pass-through (SPNPT) drugs. The pass-through program is intended to provide adequate payment to hospitals

In this chapter

- Background
- Identifying drugs that should be separately payable in the OPPS
- Considering the criteria used in various Medicare payment systems for the OPPS
- How long should a drug be separately payable?
- Summary

for drugs that are relatively costly and new to the market. In contrast, the SPNPT program is intended to provide adequate payment for relatively high-cost drugs that are already established in the drug market. Total Medicare spending (combined program spending and beneficiary cost sharing) for pass-through drugs and SPNPT drugs has grown rapidly, increasing from \$5.1 billion in 2011 to \$12.9 billion in 2018. Most of that growth in drug spending—82 percent—was for cancer treatment drugs.

For a drug to be granted pass-through status, it must be new to the market, and it must have costs that exceed several thresholds relative to the OPPS payment rate of the associated service. By statute, drugs can have pass-through status for two to three years. For a drug to have SPNPT status, it must have costs per day that exceed a threshold (\$130 in 2020) and it cannot be a “policy-packaged” drug, which is a drug in a category that CMS has determined is always packaged with the associated service. The categories of policy-packaged drugs include anesthesia drugs; drugs, biologics, and radiopharmaceuticals that function as supplies in diagnostic tests or procedures; and drugs and biologics that function as supplies in surgical procedures.

Packaging drugs into payment bundles provides a strong incentive for providers to be efficient. However, packaging all drugs can put providers at excessive financial risk, which can lead them to avoid infrequently used or high-cost drugs and adversely affect access to treatments that may improve patient care, which, in turn, can adversely affect incentives for drug innovation. At the same time, paying separately for drugs creates distortions in payments, and these distortions can lead to overuse of high-cost drugs and shift financial pressure from providers to Medicare. In addition, separate payments for drugs reduce price competition among manufacturers, which can lead to greater drug price inflation. Therefore, Medicare must be judicious concerning separately payable drugs and balance the desire to promote innovation with the need to maintain pressure on providers to be efficient.

The current criteria for both pass-through drugs and SPNPT drugs have been in place for more than 15 years. The Commission is concerned that the criteria for eligibility under both policies do not strike an appropriate balance between promoting access to innovative treatments and maintaining pressure on providers to be efficient. In particular, we are concerned about the rising cost of Part B drugs, and these policies for separately payable drugs do little to discourage high launch prices set by drug manufacturers or excessive use by providers. Both policies use cost criteria to identify drugs for program eligibility. The cost criteria are different between the programs, but we are concerned that both allow eligibility for drugs that could be packaged without placing excessive financial risk on hospitals. Also, neither policy requires drugs to be clinically superior to competing drugs, even

though a requirement for clinical superiority implicitly encourages innovation. As a result, Medicare could pay separately for a drug no more effective than an existing product, even when the cost of the existing product is reflected in the OPPS payment. This possibility could result in Medicare paying twice for a drug.

We reviewed criteria used to identify separately payable drugs in several payment systems for hospital services: the Medicare OPPS, the Medicare inpatient prospective payment system, and the ambulatory patient group system developed by 3M™ Health Information Systems. Taken together, these three systems use four criteria for identifying separately payable drugs:

- The drug must be new to the market.
- The cost of the drug must be high in relation to the payment rate of the associated procedure.
- The dollar cost of the drug must be high.
- The drug must show clinical superiority over other drugs with a similar therapeutic use.

All of these criteria could be used in the OPPS. However, no payment system combines the use of all four of these criteria, and the use of all four could be overly stringent.

We emphasize that the purpose of this analysis is to evaluate potential criteria for identifying drugs that should be separately payable in the OPPS. The Commission will provide further analysis to determine the specific criteria that should be used and the parameters of those criteria. At the present stage, we are certain that an effective system of separately payable drugs should have two features:

- Some drugs should be paid separately because they are not ancillary. These drugs are the purpose for a visit, are high cost, treat a condition, and are usually administered by infusion. Many of these drugs are for cancer treatment, but some, such as infliximab for treatment of autoimmune disorders, treat other conditions. Separate payment for these drugs is consistent with the policy in the ambulatory patient group system.
- Drugs should show clinical superiority over other drugs to have separately payable status. A clinical superiority requirement is vital. Without one, as noted above, Medicare could pay separately for a drug no more effective than an existing product, even when the cost of the existing product is reflected in the OPPS payment. This situation results in double payments by Medicare.

In future work, we will perform analyses to determine other criteria for identifying drugs that should be separately payable. We will also perform analysis to determine the parameters for those criteria. ■

Background

The unit of payment in the hospital outpatient prospective payment system (OPPS) is the primary service (the service that is the reason for the visit, such as a clinic visit or a device implant) coupled with the ancillary items that are provided with and adjunctive to the primary service (such as a diagnostic X-ray during a clinic visit). The OPPS packages the ancillary items with the related primary service into a single payment bundle. The rationale for packaging ancillary items rather than paying separately for them is to create an incentive for hospitals to identify the most efficient way to provide a primary service. The packaging of ancillary items contrasts with a fee schedule in which providers receive a separate payment for each service provided—the primary service and the ancillary items.

The packaging of ancillary items does not mean that OPPS payments do not reflect the cost of packaged ancillaries because the payment rates for primary services reflect the costs of the packaged items. For example, if a packaged ancillary costs \$20 and is provided 50 percent of the time for patients who receive a particular primary service, then \$10 (50 percent of \$20) is included in the estimated cost for the primary service when setting the payment rate. A simple example of how packaging works under the OPPS is a case of someone having a bad cough with chest discomfort and congestion. If this person goes to an outpatient clinic of a hospital, the physician might order a chest X-ray to check for pneumonia. In this case, the visit to the clinic would be the primary service, while the chest X-ray, an ancillary service, would be packaged with the primary service.

In the OPPS, CMS identifies services using Healthcare Common Procedure Coding System (HCPCS) codes. CMS creates a payment bundle by combining the HCPCS code of the primary service with the HCPCS codes of the packaged ancillary items. CMS collects the HCPCS codes of the primary services into ambulatory payment classifications (APCs), which are groups of services that have similar clinical characteristics and costs. For each APC, CMS determines a payment rate that is based on the geometric mean cost of all the services in the APC.¹ All of the primary services in an APC have the same payment rate.

Although packaging ancillary items encourages efficiency by giving hospitals a financial incentive to consider all of

the input costs related to the delivery of primary services, not all ancillary items should be packaged. If the OPPS packaged ancillary items that are expensive or infrequently provided with a particular primary service, the financial risk to hospitals (and the risk of stinting on care) would be excessive. For example, if the OPPS packaged a \$500 drug that is provided 1 percent of the time with the primary services in an APC, the payment rate for this primary service would include only \$5 for this drug. That is, the difference between the cost of the drug and how much of its cost is reflected in the payment rate of the related service would be \$495.

A category of ancillary items that has grown in importance in the OPPS is drugs covered under Medicare Part B. By volume, the OPPS treats most drugs as packaged items because their cost is low enough that packaging does not pose a high financial risk. However, through statute and through CMS regulatory action, the OPPS has two policies for paying some drugs separately from primary services: pass-through drugs and separately payable non-pass-through (SPNPT) drugs. At times, we refer to these two groups collectively as “separately payable drugs.” Each pass-through drug and each SPNPT drug has its own APC and payment rate. From 2011 to 2018, total Medicare spending (combined program spending and beneficiary cost sharing) for pass-through and SPNPT drugs increased from \$5.1 billion to \$12.9 billion.² Most of that growth in drug spending—82 percent—was for cancer treatment drugs, and the growth reflects strong increases in volume and prices.

As we consider which drugs should be paid separately and which should be packaged, we should be aware that not all drugs are ancillary items. In situations in which receiving a drug is the reason for the patient visit, the drug is not ancillary. These drugs are usually very expensive, are used to treat medical conditions, and are usually administered by infusion. Many of these drugs are used to treat cancer. Because of their high cost and because they are not ancillary, these drugs should be separately payable.

Existing policy for pass-through drugs

The Congress established pass-through drugs through Section 1833(t)(6) of the Social Security Act. Before CMS implemented the OPPS, there was concern that data on the cost of new drugs would not be available when setting the APC payment rates. Consequently, providers could be underpaid for these new drugs because the cost

**TABLE
6-1**

The programs for pass-through drugs and separately payable non-pass-through drugs have important differences, but neither requires clinical superiority

Program feature	Pass-through drugs	Separately payable non-pass-through drugs
New to market	Required	Not required
Time limit	Two to three years	No limit
Cost	Cost must exceed three thresholds related to primary service	Cost must exceed \$130 per day
Clinical superiority	Not required	Not required

Source: Final rule regulations on the hospital outpatient prospective payment system from CMS.

of those drugs would not be reflected in the APC payment rates, which could adversely affect the use of those drugs and, thus, be a disincentive to innovation. As a result, the Congress established pass-through payments for new drugs that have high costs relative to the payment rates of their associated primary services' APCs. Pass-through payments are additional payments that providers receive above the value of the drugs that are packaged into the payment rate of a service when the providers use a pass-through drug. To implement the statute, CMS established requirements for a drug to have pass-through status:

- The item must be new, meaning that payment for the drug was not being made as of December 31, 1996.
- The cost of the drug is not insignificant in relation to the OPPTS payment rate for the related service (or group of services). CMS has determined that drug costs are not insignificant if they meet all of these thresholds:
 - The estimated average reasonable cost of the drug exceeds 10 percent of the APC payment amount for the service related to the drug.
 - The estimated average reasonable cost of the drug exceeds the drug portion of the APC payment amount for the related service by at least 25 percent.
 - The difference between the estimated reasonable cost of the drug and the drug portion of the APC payment amount for the related service must exceed 10 percent of the APC payment amount for the related service.

Because the purpose of the pass-through program is to provide adequate payment for new, relatively costly drugs while CMS collects the necessary cost data for including the cost of these drugs in the APC payment rates of the related service, pass-through status is time limited. A drug can have pass-through status for two to three years. Despite requirements that pass-through drugs meet three cost thresholds, it is possible that relatively low-cost drugs, which arguably pose minimal financial risk to hospitals, can become pass-through drugs. For example, Lumason—a contrast agent used in ultrasound imaging—has pass-through status and costs about \$23 per day.

Existing policy for separately payable non-pass-through drugs

The program for SPNPT drugs exists from a combination of legislation and a regulatory decision by CMS. The Medicare Prescription Drug, Improvement, and Modernization Act of 2003 (MMA) defined specified covered outpatient drugs (SCODs) and mandated separate payment for them in the OPPTS. The MMA defined SCODs as drugs that had pass-through status before January 1, 2003. The MMA also requires that payment for SCODs from 2006 forward be equal to the average acquisition cost for the drug, subject to adjustments for overhead costs. CMS has used average sales price (ASP) as the basis of payment for SCODs, with adjustments to account for overhead costs that CMS has varied over time.

Through regulation, CMS established a policy that created SPNPT drugs: SCODs plus other drugs that are not SCODs but have costs per day that exceed a cost threshold (\$130 in 2020). CMS adjusts this cost threshold each year using the producer price index for pharmaceutical preparations. However, CMS has established that certain

drugs must be packaged if they do not have pass-through status, which means they cannot be SPNPT drugs. CMS refers to these drugs as policy-packaged drugs. These drugs include anesthesia drugs; drugs, biologics, and radiopharmaceuticals that function as supplies in diagnostic tests or procedures; and drugs and biologics that function as supplies in surgical procedures.

The SPNPT program is distinct from the pass-through program in three important ways (Table 6-1). First, the SPNPT program is for established drugs, while the pass-through program is for new drugs. Second, the SPNPT program has no limit on how long a drug can hold SPNPT status, while the pass-through program limits eligibility to two to three years. Third, the cost requirements are very different between these two programs because pass-through drugs have to have costs that exceed three thresholds related to the payment rate of the associated service and SPNPT drugs simply have to exceed a cost per day threshold. Neither program requires drugs to show clinical superiority over other drugs.

Identifying drugs that should be separately payable in the OPSS

Packaging drugs into payment bundles provides a strong incentive for providers to be efficient. However, packaging all drugs can put providers at risk for substantial financial loss, which can lead them to avoid rarely used or high-cost drugs and adversely affect access to treatments that may improve patient care, which, in turn, can adversely affect incentives for drug innovation. At the same time, overly lenient criteria for separately payable status can lead to overuse of separately payable drugs and shift financial pressure from providers to Medicare. In addition, separate payments for drugs reduces price competition among manufacturers, especially new, separately payable drugs versus established drugs that may be packaged, which can lead to greater drug price inflation. Therefore, Medicare must be judicious concerning separately payable drugs and must balance a desire to promote access to innovative treatments with the need to maintain pressure on providers to be efficient.

The current criteria for both pass-through drugs and SPNPT drugs have been in place for 15 years. We are concerned that the criteria for eligibility in both programs do not strike an appropriate balance between promoting

innovation and maintaining appropriate pressure on providers. Both programs use cost criteria to identify drugs for program eligibility, but we are concerned that both can allow separately payable status to drugs that could be packaged without placing excessive financial pressure on hospitals. In particular, the Commission is concerned about the rising cost of Part B drugs, and these policies for separately payable drugs do little to discourage either high launch prices set by drug manufacturers or excessive use by providers. In part, our concern stems from the fact that Medicare spending on separately payable drugs in the OPSS has rapidly increased, from \$5.1 billion in 2011 to \$12.9 billion in 2018.

Under the pass-through program, there is a risk of allowing separately payable status for low-cost drugs that could be packaged because there is no requirement that a drug's cost must exceed a dollar threshold to be a pass-through drug. There is evidence that low-cost drugs do become pass-through drugs, such as the example of Lumason discussed earlier. Under the SPNPT program, there is no requirement that a drug's cost must be high in relation to the payment rate of the associated service. We are also concerned that neither program requires drugs to be clinically better than competing drugs, even though a requirement for clinical superiority implicitly encourages innovation. As a result, Medicare could pay separately for a drug no more effective than an existing product, even when the cost of the existing product is reflected in the OPSS payment. This situation results in Medicare making a double payment.

We seek to develop a program for separately payable drugs in the OPSS that improves on the two current programs. To identify criteria that could be used to determine which drugs should be separately payable, we assessed the criteria for separately payable drugs used in several payments systems. These payment systems include the OPSS, the inpatient prospective payment system (IPPS) in the Medicare program, and the ambulatory patient group (APG) system developed by 3MTM Health Information Systems (3M HIS). Referring to this assessment, we discuss whether each of these criteria would be appropriate for the OPSS.

Payment systems for hospital services use four criteria to identify separately payable drugs

We reviewed papers by analysts at 3M HIS that describe the features of the APG system, which served as a model

for the APC system that CMS uses in the OPSS (3M Health Information Systems 2019, Averill et al. 1993, Goldfield et al. 2008). These papers indicate that, during the development of the APG system, 3M HIS considered, but did not implement, an elaborate system in which decisions to package ancillary items (including drugs) would be based on the cost of the ancillary item in relation to the cost of the associated service and how often the ancillary item is used with the associated service (Averill et al. 1993). 3M HIS also considered, and implemented, a less complicated system that paid separately for ancillary items that 3M HIS considered costly without consideration of the cost of the associated service. This system has resulted in the packaging of all drugs except those that are administered by means of infusion and constitute the reason for a visit, which are paid separately. The separately paid drugs are predominantly chemotherapy drugs.

We have already discussed the criteria for eligibility for the two programs for separately payable drugs in the OPSS, pass-through drugs and SPNPT drugs. A summary of these criteria includes the following:

- Pass-through drugs—Must be new to the market; must have costs relative to the payment rate of the associated service that exceed three thresholds
- SPNPT drugs—Must have cost per day that exceeds \$130; cannot be policy-packaged drugs (largely drugs that function as supplies in a primary service)

In the IPPS, the new-technology add-on payment (NTAP) program provides separate payment for new drugs and devices that meet several criteria. For a drug to qualify for NTAP status, it must be new to the market, its cost relative to the payment rate of the applicable diagnosis related group must exceed a threshold determined by CMS, and it must show substantial clinical improvement (clinical superiority) over other drugs.³

In summary, the criteria that the APG system, the OPSS, and the IPPS use or considered using to determine whether drugs should be separately paid include the following: the drug's cost must be high in relation to the payment rate of the associated service, the drug has a high dollar cost, the drug must be new to the market, and the drug must show clinical superiority over competing drugs. We will consider each of these criteria in our effort to identify the criteria that drugs should meet to be eligible for separate payment under the OPSS.

Cost of drug relative to the payment rate of the associated service: Precise but complicated

The benefit of using the cost of a drug relative to the payment rate of the associated service or services as a criterion is that, for a given drug, there are situations for which packaging is reasonable and other situations for which separate payment is beneficial. Using the cost of the drug relative to the payment rate of the associated service, we can identify these different situations. If a drug is used frequently with different services, the cost of the drug relative to the payment rates of the associated services can vary. In some cases, the cost of the drug may be high relative to the payment rate. In these cases, it may be beneficial to pay separately. In other cases, the cost of the drug may be relatively low. In these cases, packaging the drug is likely to be reasonable.

A disadvantage of using cost relative to the payment rate of the associated service is the potential for complication and confusion. A drug could be packaged when used with some services and paid separately when used with others, which could be confusing for hospital staff and for claims processors.

Calculation of the cost of a drug in relation to the payment rate of the associated service uses the price of the drug, how frequently the drug is used with the associated service, and the payment rate of the associated service. Consider a situation in which a drug has a cost of \$300 and is used with a service that would have a payment rate of \$300 if the drug is paid separately:

- If this drug is used 5 percent of the time with this service, packaging the drug would add \$15 ($0.05 \times \300) to the payment rate for the service (for a total payment of \$315). In this case, it is reasonable to pay separately for the drug because, if the drug is packaged, the difference between the cost of the drug and the amount of the drug cost included in the payment rate of the associated service is \$285, which is 95 percent of the payment rate for the service.
- Conversely, if this drug is used 95 percent of the time with this service, packaging the drug would add \$285 to the payment rate for the service (for a total payment of \$585). In this case, it is reasonable to package the drug because the difference between the drug cost and the amount of the drug cost included in the payment rate of the associated service is just \$15, which is only 5 percent of the payment rate for the service.

This example suggests a formula that could be used to determine whether hospitals face excessive risk if a drug is packaged:

$$[(\text{cost of drug}) - (\text{percentage of time drug used with service}) \times (\text{cost of drug})] / (\text{payment rate for service}).$$

If the result of this formula is greater than some percentage, such as 10 percent, then it would be reasonable to pay separately for the drug. If it is less than the percentage, then it would be reasonable to package the drug.

This formula is similar to the formula that the Commission uses to calculate margins for evaluating appropriate updates to Medicare payment rates. The numerator is the difference between the cost of a drug and the portion of the payment for a service that is for that drug. The denominator is the total payment for the service. The formula indicates the loss that a hospital would experience each time it used a drug that is packaged. Note that because the drug cost is packaged into the payment rate of the associated service, the provider would receive an implicit payment for the drug even when the drug is not used with the service.

High dollar cost per day: Straightforward but can be imprecise

The benefit of a requirement that a drug have a high cost is that it is straightforward and uncomplicated. If a drug is determined to be high cost—for example, the cost per day exceeds a dollar threshold—it is paid separately. Otherwise, it is packaged. This criterion presents a dichotomous situation, which is different from a criterion that requires a drug to have high cost in relation to the associated service, which can produce situations in which a drug is sometimes packaged and sometimes paid separately.

One disadvantage of a requirement that a drug be high cost is that it can be somewhat imprecise. Some drugs would have separately payable status even though packaging the drug would not put excessive financial pressure on hospitals. For example, if the OPPS paid separately for all drugs that have a cost of more than \$130 per day, a drug that cost \$140 per day would be paid separately. If this drug were packaged with a procedure that had a \$10,000 payment rate, the hospital would not be under excessive financial risk because the cost of the drug would be small relative to the payment rate of the procedure.

A second disadvantage of this cost requirement is that it encourages manufacturers to set high prices or at least prices just above the cost per day requirement.

New to the market: Ensures adequate payment for new drugs and supports innovation

Being new to the drug market is a requirement for a drug to be eligible for the pass-through drug program and the NTAP program (which includes both drugs and devices). The purpose of these programs is to ensure adequate payment for new technology because of concerns that the necessary cost and use data are not available to include new drugs in the payment rates of the associated services. If the cost of new drugs is not reflected in payment rates, hospitals could choose not to use these new drugs, and patients' access to innovative new treatments could be diminished. Therefore, a program of separate payment for some new drugs is beneficial for adequate payment and access to innovative products. However, the duration of separate payment should be limited to the length of time needed to collect the necessary data for including the cost of new drugs in the payment rates of the associated services, generally two to three years. When the necessary cost and use data are available for including new drugs in the payment rates for the associated services, whether these drugs should be packaged or separately payable should be reconsidered along with the other established drugs.

Clinical superiority: Prevents double payments and increases incentives for innovation

Given the high threshold for reducing the financial incentives of bundled payments by carving out drugs (or other items or services), an important factor in determining whether a drug should be separately payable is that it shows clinical superiority over drugs that have similar therapeutic uses. Without a clinical superiority criterion, the Medicare program could pay separately for drugs that are not clinically better than drugs that are packaged. This situation would result in double payments by Medicare: a payment for the cost of the packaged drug and a distinct payment for the separately payable drug. Also, incentives to produce innovative drugs would be increased if drugs had to show clinical superiority to obtain separately payable status.

In the NTAP program, a drug demonstrates clinical improvement if it meets any one of the following criteria:

- The drug offers a treatment option for a patient population unresponsive to, or ineligible for, other available treatments.
- The drug offers the ability to diagnose a medical condition in a patient population for which that

medical condition is otherwise undetectable or offers the ability to diagnose a medical condition earlier in a patient population than allowed by other methods, and use of the drug affects the management of the patient.

- Use of the drug improves clinical outcomes relative to other drugs, such as:
 - a reduction in at least one clinically significant adverse event, including a reduction in mortality or a clinically significant complication;
 - a decreased rate of at least one subsequent diagnostic or therapeutic intervention (for example, due to reduced rate of recurrence of the disease process);
 - a decreased number of future hospitalizations or physician visits; or
 - a more rapid beneficial resolution of the disease process including, but not limited to, a reduced length of stay or recovery time, an improvement in one or more activities of daily living, an improved quality of life, or a demonstrated greater medication adherence or compliance.
- The totality of the circumstances otherwise demonstrates that the drug substantially improves, relative to other drugs, the diagnosis or treatment of Medicare beneficiaries.

CMS established a similar list for pass-through devices in the OPSS, which includes two additional possibilities: (1) decreased pain, bleeding, or other quantifiable symptom and (2) reduced recovery time.

The clinical superiority criteria from both the NTAP and pass-through device programs could be used in the OPSS to determine clinical superiority for drugs, and we believe that drugs that meet the requirements under either program would demonstrate true innovation.

However, implementing a clinical superiority criterion necessitates addressing what to do when drugs with similar therapeutic purposes are clinically beneficial in different ways. Consider a situation where two different drugs (Drug A and Drug B) treat the same condition, but Drug A is better than Drug B in a particular clinical attribute (perhaps it results in fewer adverse events) while Drug B is better than Drug A in a different clinical

attribute (more rapid resolution of the disease process). There are at least two approaches for addressing this issue:

- Among drugs that have similar therapeutic uses, identify one and only one drug as being clinically better than the others. This approach would provide clarity about which drug in a given class is considered the best drug, but it may create situations where a drug has been identified as the best in its class while other drugs in the same class perform better in some clinical aspects.
- If a drug is clinically better than other drugs in its therapeutic class in *at least one clinical measure*, allow it to have separately payable status even if another drug in the same class is better in a different clinical measure. This approach would allow both Drug A and Drug B from the above example to be separately payable drugs.

Considering the criteria used in various Medicare payment systems for the OPSS

If a payment system required a drug to satisfy all four criteria that we discussed in the previous section to qualify for separately payable status, Figure 6-1 illustrates how the decision for separately payable status would work in practice. We do not know of a payment system that requires a drug to meet all four of these criteria to qualify for separately payable status. Therefore, a payment system that requires a drug to meet all four of these criteria would likely be more restrictive than any policy currently in use.

As a starting point in identifying drugs that should be separately payable in the OPSS, recall that the OPSS creates payment bundles by packaging the cost of ancillary items into the payment rates of primary services. While most drugs are ancillary items, some drugs are the reason for outpatient visits and are not ancillary. These drugs are expensive, dominate the cost of the visit, are used to treat medical conditions, and are usually administered by means of infusion techniques. Many of these drugs treat cancer, but some, such as infliximab for autoimmune disorders, treat other conditions. Because these drugs are not ancillary items, they should be separately payable. Paying separately for these drugs would be similar to the policy under the Enhanced Ambulatory Patient Group (EAPG) system—the most recent version of the APG system—

**FIGURE
6-1**

Possible decision criteria for identifying separately payable drugs

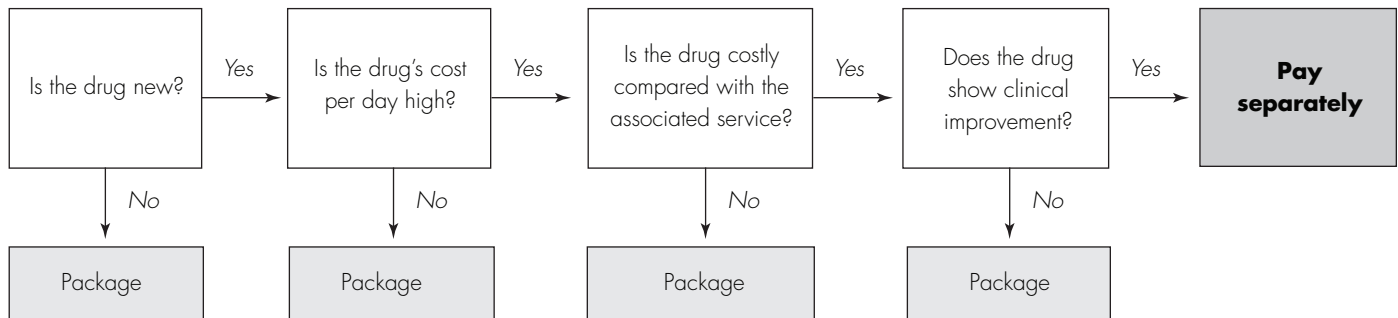

which pays separately for all infused drugs and packages all other drugs (3M Health Information Systems 2019).⁴

For the other drugs that are ancillary, the Commission intends to develop a program of separately payable drugs under the OPDS that is different from the two programs currently in use. The four criteria that we discussed in the previous section can serve as a starting point for identifying the criteria for an effective system, but we need to determine which of those criteria to use, then determine the parameters for the criteria selected.

Drug must be new to the market

The benefit of a requirement that a drug has to be new to the market is that it can increase incentives for drug manufacturers to produce innovative new products. However, allowing separate payments only for new drugs could adversely affect use of expensive drugs that are already on the market. Therefore, an important question related to this criterion is, what should be done about drugs that are already on the market? Options include:

- Implement a “new” criterion but let established drugs keep their current status; they are either packaged or paid separately under existing rules.
- Implement a “new” criterion and package all drugs that are already on the market. This option could be implemented immediately or a transition period could be used in which established drugs keep their current status for a limited period (two to three years), then package them.

- Do not use a “new” criterion and subject established drugs to the same criteria for separately payable status as new drugs.

Analysis is needed to determine the best option. If we find that most of the established drugs that are currently separately payable would be in the category of the expensive, nonancillary drugs that we have already designated as separately payable, then a “new” requirement for ancillary drugs would be reasonable because there would be few existing separately payable ancillary drugs affected by the policy.

Drug must have a high dollar cost

Drugs that have a low cost per day should be packaged because packaging them would not expose hospitals to excessive financial risk. Therefore, we assert that a separately payable drug should have a cost per day that exceeds a dollar threshold. A question that obviously must be answered is: At what level should we set the cost per day threshold?

The program for SPNPT drugs has a threshold of \$130 per day for 2020, and CMS updates this threshold for drug price inflation each year. The Congress established the initial threshold for SPNPT drugs at \$50 per day for both 2005 and 2006 in the Medicare Prescription Drug, Improvement, and Modernization Act of 2003. CMS has updated the initial \$50 threshold for drug price inflation each year beginning in 2007. At this time, we are not sure whether the threshold used by CMS is appropriate because

it is not based on empirical evidence. The Commission will do an empirical analysis to determine an appropriate threshold. The threshold that is selected should be adjusted each year based on inflation.

Drug's cost must be high relative to the payment rate of the associated service

CMS applies this criterion in the pass-through drug program by requiring pass-through drugs to have costs that exceed three thresholds in relation to the payment rate of the associated service. In relation to the cost per day criterion, drug cost in relation to the associated service is more complex because it includes three variables rather than one: cost of the drug, payment rate of the associated service, and how frequently the drug is used with the associated service. A useful method for determining whether the cost of a drug is high in relation to the payment rate of the associated service is to calculate the difference between the cost of the drug and how much of that cost would be reflected in the payment rate of the associated service if the drug were packaged. This difference indicates the loss a hospital would experience each time it uses the drug (note that because the drug is packaged, the provider receives an implicit payment for the drug when it does not use it). That difference would be compared with the payment rate of the associated service. A formula that represents this comparison is the following:

$$[(\text{cost of the drug}) - (\text{percentage of time drug is used with associated service}) \times (\text{cost of the drug})] / (\text{payment rate of associated service})$$

If the result of this equation is greater than some percentage, such as 10 percent, then it would be reasonable to pay separately for the drug. If it is less than the percentage, then it would be reasonable to package the drug.

Drug must show clinical superiority

The Commission asserts that clinical superiority is a necessary requirement for a new drug to be granted separately payable status. Without a clinical superiority requirement, a new drug could become separately payable even though it has no clinical benefit over packaged drugs that have similar therapeutic uses. Under this scenario, Medicare would make double payments when a hospital uses the separately payable drug, one for the packaged drug and one for the separately payable drugs. Moreover, requiring clinical superiority for new drugs would provide incentive for drug innovation.

A clinical superiority requirement would compare the performance of a drug with drugs that have similar therapeutic uses. If the drug is clinically better in some way, such as it resolves the disease process faster, then the drug can be separately payable. The NTAP in the IPPS and the pass-through device program in the OPSS have clinical superiority requirements, and the two programs have similar, but slightly different, options for an item to indicate clinical superiority. Because the NTAP program encompasses both devices and drugs while the pass-through program encompasses only devices, the options for showing clinical superiority in the NTAP program are likely a better fit for determining clinical superiority among drugs in the OPSS.

While use of a clinical superiority criterion is straightforward to apply if only new drugs can be separately payable, it becomes more complicated if established drugs also are allowed to be separately payable, for two reasons. First, a clinical superiority requirement is intended to spur innovation (stated earlier), and it would be logically inconsistent to apply such a requirement to drugs that have already been introduced to the market. Second, it would make the assessment of which drugs are clinically superior more costly and complicated. Consider a class of drugs that has one new drug and five established drugs. If only new drugs can be separately payable, an assessment for clinical superiority would require only a comparison of the new drug with each of the five established drugs. In contrast, if both new drugs and established drugs can be separately payable, an assessment for clinical superiority would require each drug to be compared with all the other drugs in the class.

How long should a drug be separately payable?

Should there be a time limit for how long a drug can be separately payable, or should drugs be allowed to hold separately payable status indefinitely? The two programs for separately payable drugs in the OPSS have different rules on this issue. The pass-through program limits a drug to pass-through status for two to three years, while the SPNPT program allows a drug to hold that status indefinitely. Possible approaches for a new program of separately payable drugs in the OPSS include:

- Allow only new drugs to be separately payable and limit their time. After their time expires, they are

packaged. This approach can spur incentives for innovation.

- Allow only new drugs to be separately payable, but allow them to hold that status until manufacturers produce a new drug that is clinically superior. This approach may further spur incentives for innovation because the length of time as separately payable is not definite.
- Allow both new drugs and established drugs to have separately payable status. We could classify drugs by therapeutic use. In each therapeutic class, we would determine whether each drug is better than the other drugs in its class in at least one measure of clinical performance. This approach would allow for more than one drug in a therapeutic class to be separately payable.

Summary

Because of the benefits of packaging, the Commission encourages packaging drugs to the fullest extent without subjecting hospitals to excessive financial loss. In other words, the Commission would like a system that limits separately payable drugs to those drugs that would pose an excessive financial risk to hospitals if they are packaged.

To develop such a system, we will make decisions about each of the four criteria that we discussed in this report. The Commission is certain that an effective system of separately payable drugs should have two features:

- Some drugs should be paid separately because they are not ancillary. These drugs are the purpose for a visit, are high cost, treat a condition, and are usually administered by infusion. Many of these drugs are for cancer treatment, but some, such as infliximab for treatment of autoimmune disorders, treat other conditions. Separate payment for these drugs is consistent with the policy in the APG system.

- Drugs that are ancillary items should show clinical superiority over other drugs to have separately payable status. A clinical superiority requirement is vital. Without one, Medicare could pay separately for a drug no more effective than an existing product, even when the cost of the existing product is reflected in the OPPS payment. This situation would result in a double payment by Medicare.

If we determine that no drugs should be paid separately other than those that are not ancillary, the result would be a system of separately payable drugs that is similar to the EAPG system.

If we determine that some drugs other than the nonancillary drugs should be separately payable, then we would have to determine whether only drugs that are new to the market should be allowed to be separately payable or whether established drugs also should be allowed. Irrespective of that decision, we would also have to make decisions about the two cost-related criteria:

- *Cost per day must exceed a dollar threshold.* It is not clear whether the \$130 per day threshold that CMS uses in the program for SPNPT drugs is the appropriate level. Empirical analysis is needed.
- *Cost of the drug relative to the payment rate of the associated service exceeds a threshold.* When a drug is packaged, the difference between the cost of the drug and the amount of the cost that is reflected in the payment rate of the associated service is the loss a hospital faces each time it uses that drug with that service. We would have to determine the point at which that loss in relation to the payment rate of the associated service places excessive risk on hospitals.

In future work, we will perform analyses to determine other criteria for identifying separately payable drugs and determine the parameters for those criteria. ■

Endnotes

- 1 The formula for the geometric mean differs from the formula for the more common arithmetic mean. The formula for the geometric mean of a sample of N numbers is $(\prod Y_i)^{(1/N)} = (Y_1 * Y_2 * \dots * Y_n)^{(1/N)}$. The formula for the arithmetic mean of a sample of N numbers is $(\sum Y_i)/N = (Y_1 + Y_2 + \dots + Y_n)/N$. An important difference between the geometric mean and the arithmetic mean is that outliers (unusually high or unusually low values) have a smaller effect under the geometric mean.
- 2 The level of program spending and beneficiary cost sharing in 2018—\$12.9 billion—was mitigated by a policy that CMS instituted in 2018 that reduces the OPSS payment rate for SPNPT drugs obtained through the 340B Drug Pricing Program from 106 percent of the average sales price (ASP + 6 percent) to ASP – 22.5 percent. We estimate that if the OPSS payment rate for SPNPT drugs had been ASP + 6 percent in 2018, combined program spending and beneficiary cost sharing would have been \$14.8 billion in 2018.
- 3 For 2020, CMS has changed the NTAP criteria for meeting substantial clinical improvement. For products that have received a designation as a breakthrough device from the Food and Drug Administration, CMS does not require the standard clinical improvement criteria. All other items must still meet the standard criteria for clinical improvement.
- 4 The EAPG system collects separately paid cancer treatment drugs into several categories on the basis of drug cost. All drugs in the same category have the same payment rate. The EAPG system does the same thing for all separately paid noncancer drugs. In contrast to the EAPG system, the OPSS provides a distinct, separate payment rate for each separately paid drug. The EAPG method can be thought of as a technique of consolidated billing.

References

3M Health Information Systems. 2019. 3M enhanced ambulatory patient grouping systems: Methodology overview. https://apps.3mhis.com/docs/Groupers/Enhanced_Ambulatory_Patient_Grouping_EAPGS/methodology_overview/grp403_eapg_meth_overview.pdf.

Averill, R. F., N. I. Goldfield, M. E. Wynn, et al. 1993. Design of a prospective payment patient classification system for ambulatory care. *Health Care Financing Review* 15, no. 1 (Fall): 71–100.

Goldfield, N., R. Averill, J. Eisenhandler, et al. 2008. Ambulatory patient groups, version 3.0—A classification system for payment of ambulatory visits. *Journal of Ambulatory Care Management* 31, no. 1 (January–March): 2–16.

CHAPTER

7

**Improving Medicare's
end-stage renal disease
prospective payment system**

R E C O M M E N D A T I O N S

7-1 The Congress should direct the Secretary to eliminate the end-stage renal disease prospective payment system’s transitional drug add-on payment adjustment for new drugs in an existing end-stage renal disease functional category.

COMMISSIONER VOTES: YES 17 • NO 0 • NOT VOTING 0 • ABSENT 0

.....

7-2 The Secretary should replace the current low-volume and rural payment adjustments in the end-stage renal disease prospective payment system with a single adjustment for dialysis facilities that are isolated and consistently have low volume, where low-volume criteria are empirically derived.

COMMISSIONER VOTES: YES 17 • NO 0 • NOT VOTING 0 • ABSENT 0

Improving Medicare’s end-stage renal disease prospective payment system

Chapter summary

Since 2011, Medicare has paid dialysis facilities under a prospective payment system (PPS) that is based on an expanded bundle of services that includes end-stage renal disease (ESRD) drugs and biologics (hereafter referred to as “drugs”), clinical laboratory tests, and other items and services that were previously paid separately. Drugs included in the bundle are those that can be classified into 1 of 11 ESRD-related functional drug categories, similar to therapeutic classes of drugs. Medicare pays dialysis facilities a case-mix-adjusted base rate for this bundle of services furnished during a dialysis treatment in the facility or in a patient’s home, generally up to three treatments per week. The base payment rate is adjusted for certain patient-level characteristics, including patients’ age, body surface area, and body mass. Base payments are also adjusted for certain facility characteristics, with separate adjustments that increase payments for facilities with low treatment volume and for facilities in rural locations. Dialysis facilities may receive separate add-on payments when furnishing certain new drugs. In this chapter, we address issues related to the expanded transitional drug add-on payment adjustment (TDAPA) for new ESRD drugs and the payment adjustments for low-volume facilities and for facilities located in rural areas.

The Protecting Access to Medicare Act of 2014 (PAMA) required CMS to implement a drug designation process for including new injectable and

In this chapter

- Background
- Current payment for new ESRD drugs under the ESRD PPS
- Eliminating the TDAPA for new drugs in an existing ESRD functional category
- Current payment for low-volume and rural dialysis facilities
- Improving the adequacy of payments for low-volume and isolated facilities

intravenous products into the ESRD PPS bundled payment. Accordingly, the agency established a process that pays dialysis facilities separately for qualifying products under a TDAPA. The original TDAPA policy for new ESRD drugs that CMS adopted in 2016 applied only to drugs that are *not* in 1 of the 11 ESRD functional categories. As of January 1, 2020, CMS expanded the TDAPA to apply to certain dialysis drugs, including biosimilars, that are in 1 of the 11 ESRD functional categories of drugs included in the ESRD bundle. Under the expanded policy, CMS makes a TDAPA for new ESRD-related injectable and intravenous drugs, unless they are generic equivalents or new dosage forms or formulations of drugs included in an existing ESRD functional category, among others. The process that CMS uses to identify eligible products is based on the pathways that the Food and Drug Administration employs to approve new drugs. The agency pays dialysis facilities the eligible product's average sales price for two years; thereafter, the new product is included in the PPS payment bundle without any increase to the base rate. No products have been paid for under the expanded TDAPA policy in 2020. (Since 2018, CMS pays for calcimimetics under a TDAPA policy that is distinct from the expanded TDAPA policy for new ESRD drugs.)

The Commission has raised concerns about the expanded TDAPA policy, underscoring the importance of maintaining the structure of the ESRD PPS and not creating policies that would unbundle services or encourage high launch prices of new drugs and other technologies (Medicare Payment Advisory Commission 2019a, Medicare Payment Advisory Commission 2018). Further, we have noted that the expanded policy would pay facilities twice for a drug in a functional category by paying separately for the new drug under the TDAPA while also including payment for one or more drugs with a similar purpose or use in the ESRD PPS base rate. The duplicative payment not only is an inappropriate use of Medicare funds but also can create incentives for the excessive provision of ESRD-related products (to the extent clinically possible).

The Commission recommends that the Congress direct the Secretary to eliminate the TDAPA for new drugs that are in an existing ESRD functional category already included in the payment bundle. Doing so would maintain the structure of the ESRD PPS and avoid the introduction of incentives to unbundle services covered under the PPS. In addition, eliminating the TDAPA for these drugs would create pressure for drug manufacturers to constrain the growth of prices for new and existing ESRD drugs. At market entry, such new drugs would be included in the ESRD PPS bundle, with no update to the base payment rate. CMS will need to monitor the alignment of Medicare payments with providers' costs as new products are added to the bundle and diffuse into medical practice. The Commission's annual analysis on payment adequacy, ESRD drug use, and changes in patients' outcomes

can help inform policymakers about the future need for rebasing the ESRD PPS's base payment rate.

The Commission has also raised concerns that neither the low-volume payment adjustment (LVPA) nor the rural adjustment accurately targets facilities that both are critical to beneficiary access and have high costs warranting a payment adjustment (Medicare Payment Advisory Commission 2015, Medicare Payment Advisory Commission 2014). The LVPA, which increases a facility's base rate by 23.9 percent, applies to facilities with fewer than 4,000 total treatments in each of the 3 years before the payment year. For these years, a facility's total treatment volume is equal to the sum of (1) the treatments furnished by the facility in question and (2) the treatments furnished by only those facilities under common ownership that were within five road miles from the facility in question. The rural payment adjustment, which increases a facility's base rate by 0.8 percent, applies to all facilities located in rural areas, regardless of treatment volume or proximity to other dialysis facilities. Consequently, in 2017, about 40 percent of LVPA facilities were located within five miles of the next closest facility, while some 385 facilities that did not receive the LVPA were isolated (and therefore necessary for beneficiary access to care) and incurred substantially higher than average costs per treatment. In addition, in 2017, about half of all rural facilities were high volume, and 30 percent of rural facilities were within five miles of the next closest facility.

The Commission recommends that the Secretary replace the LVPA and rural adjustment with a single payment adjustment—a low-volume and isolated (LVI) adjustment—to better protect isolated, low-volume dialysis facilities that are critical to ensure beneficiary access. Facilities that are low volume and isolated are defined based on both a facility's distance from the nearest facility and its total treatment volume. We found that the facilities that would receive the adjustment would be more appropriately targeted. In 2017, an illustrative LVI policy would have applied to 575 freestanding and hospital-based dialysis facilities, compared with the 336 facilities receiving the current LVPA and the 1,257 facilities receiving the rural adjustment. The LVI policy would not have applied to facilities that furnished a high volume of treatments because their economies of scale generally result in lower costs per treatment, on average, than low-volume facilities. Nor would the LVI policy have applied to facilities near another dialysis facility since such facilities are not the sole providers of dialysis services in their communities and thus are not critical to maintaining access to care. Under this illustrative LVI policy, payments for LVPA-receiving facilities that are also isolated (more than 5 miles from the nearest facility) would remain

roughly the same, while payments would increase for facilities farther than 5 miles from the nearest facility and with between 4,000 and 6,000 treatments annually in the 3 years before the payment year. Payments would be reduced for facilities currently receiving a rural payment adjustment that have larger treatment volumes and for those currently receiving a LVPA that are within five miles of another facility. We intend this recommendation to be budget neutral with respect to current policy. ■

Background

In 2018, nearly 395,000 beneficiaries with end-stage renal disease (ESRD) receiving dialysis were covered under fee-for-service (FFS) Medicare and obtained dialysis from approximately 7,400 dialysis facilities. ESRD is the last stage of chronic kidney disease and is characterized by permanent, irreversible kidney failure. Patients with ESRD include those who are treated with dialysis—a process that removes wastes and fluid from the body—and those who have a functioning kidney transplant. Because of the limited number of kidneys available for transplantation and variation in patients' suitability for transplantation, about 70 percent of ESRD patients undergo maintenance dialysis. In 2018, total Medicare spending for outpatient dialysis services was \$12.7 billion.

Since 2011, Medicare has paid dialysis facilities under a prospective payment system (PPS) for an expanded bundle of services that includes ESRD-related drugs and biologics, clinical laboratory tests, and other items and services that were previously paid separately.¹ CMS established 11 ESRD-related functional drug categories, similar to therapeutic classes of drugs, that are included in the bundle. The 11 functional categories are (1) access management, (2) anemia management, (3) bone and mineral metabolism, (4) cellular management, (5) antiemetic, (6) anti-infective, (7) antipruritic, (8) anxiolytic, (9) excess fluid management, (10) fluid and electrolyte management, and (11) pain management. Among the drugs falling into the 11 functional categories are Part B ESRD injectable drugs (such as erythropoietin-stimulating agents (ESAs), iron, and vitamin D analogs) and their oral equivalents, and oral calcimimetics (which were covered under Part D before 2018) and their injectable equivalent. Oral-only dialysis drugs (phosphate binders) are currently paid for under Part D. Statutory provisions delayed the inclusion of oral-only Part D ESRD-related drugs into the Part B payment bundle until 2025.

The unit of payment covered by the PPS rate is a single dialysis treatment. Medicare pays facilities furnishing dialysis treatments in the facility or in a patient's home for up to three treatments per week, unless there is documented medical justification showing that the additional dialysis treatments are reasonable and necessary. Medicare payment for adult dialysis beneficiaries does not vary based on dialysis method (hemodialysis vs. peritoneal dialysis) or site of care (in

center vs. a beneficiary's home).² For 2020, the base payment rate is \$239.33 per treatment.

To calculate the case-mix-adjusted payment rate for a dialysis treatment, the base rate is adjusted to reflect patient-level and facility-level characteristics. Each adjustment is applied as a multiplier to the base rate. All adjustment values are greater than one by design and therefore increase the payment for all dialysis treatments above the base rate (with one exception for body surface area, which can increase, decrease, or have no effect on the base payment rate). Table 7-1 (p. 186) shows the value of patient-level and facility-level adjustments as initially implemented in 2011 and revised by CMS in 2016 (the current set of adjustments).

The labor-related portion (52.3 percent) of the base rate is adjusted for differences in area wages using the inpatient hospital wage index (calculated without regard to geographic reclassification).³ In addition to the case-mix-adjusted base rate, CMS may pay facilities:

- an outlier payment when a beneficiary's cost per treatment for outlier services exceeds a threshold. Outlier services include drugs, laboratory services, and other items that facilities separately billed before 2011 (under the old payment method).
- an add-on payment for furnishing self-dialysis training to patients beginning home dialysis. CMS pays for up to 15 training sessions for home peritoneal dialysis and 25 sessions for home hemodialysis.
- a transitional drug add-on payment adjustment (TDAPA), as of 2018, for furnishing oral and intravenous calcimimetics, drugs that are indicated for the treatment of secondary hyperparathyroidism in patients on dialysis. (Before 2018, the oral formulation was covered under Part D.) In 2018, Medicare's TDAPA payment was based on each product's average sales price (ASP), and payments equaled \$1.2 billion. CMS is continuing the TDAPA for calcimimetics in 2020 because the agency is still in the process of collecting sufficient claims data for a rate-setting analysis, at which point the products will be included in the PPS bundle.
- a TDAPA, as of 2020, for certain new ESRD drugs that are in an existing ESRD functional category or are in a new ESRD functional category. To date, no new drugs (either in an ESRD functional category or not) have qualified for an adjustment.

**TABLE
7-1**

ESRD PPS adjustment factors

Payment adjustment	Value 2011-2015	Value beginning 2016
Age		
18-44	1.171	1.257
45-59	1.013	1.068
60-69	1.000	1.070
70-79	1.011	1.000
80+	1.016	1.109
Body surface area (per 0.1 m ²)	1.020	1.032
Underweight (body mass index < 18.5 kg/m ²)	1.025	1.017
Time since onset of dialysis (<4 months)	1.510	1.327
Acute comorbidities		
Pericarditis	1.114	1.040
Gastrointestinal tract bleeding	1.183	1.082
Bacterial pneumonia	1.135	N/A
Chronic comorbidities		
Hereditary hemolytic/sickle cell anemia	1.072	1.192
Myelodysplastic syndrome	1.099	1.095
Monoclonal gammopathy	1.024	N/A
Facility low-volume status	1.189	1.239
Facility rural location	N/A	1.008

Note: ESRD (end-stage renal disease), PPS (prospective payment system), N/A (not applicable). Payment adjustment factors for adults ages 18 and older. Before 2016, CMS did not use a rural payment adjustment in the ESRD PPS. As of 2016, CMS eliminated the payment adjusters for bacterial pneumonia and monoclonal gammopathy.

Source: Centers for Medicare & Medicaid Services 2015.

Current payment for new ESRD drugs under the ESRD PPS

The Protecting Access to Medicare Act of 2014 (PAMA) required CMS to implement a drug designation process for including new injectable and intravenous products into the ESRD PPS bundled payment. Accordingly, the agency established a process that pays dialysis facilities separately for qualifying new products under a TDAPA, which is summarized in Table 7-2. Generally, CMS makes a TDAPA for new ESRD-related injectable and intravenous drugs, unless they are generic equivalents or new dosage forms or formulations of drugs included in an existing ESRD functional category. Beginning in 2020,

the agency lowered the payment for any drug that qualifies for a TDAPA from 106 percent of the drug’s ASP to 100 percent of the drug’s ASP.

TDAPA policy for new ESRD drugs not in an existing ESRD functional category

To comply with PAMA’s mandate for including new ESRD-related injectable and intravenous drugs into the prospective payment bundle, the agency finalized a policy in 2016 that pays a TDAPA for new ESRD-related injectable drugs not in 1 of 11 ESRD-related functional categories of drugs included in the PPS payment bundle. These drugs are eligible for a TDAPA for at least two years, until sufficient rate-setting data are available. When

**TABLE
7-2**

Summary of the ESRD PPS's TDAPA policy for new injectable drugs and biologics in 2020

New ESRD-related drugs and biologics that:

	Are not in an existing ESRD-related functional category	Are in an existing ESRD-related functional category
Year the add-on payment policy began	2016 (no products have been eligible for TDAPA to date)	2020 (no products have been eligible for TDAPA to date)
Is "substantial clinical improvement" standard used?	No	No
Payment rate of add-on	ASP*	ASP*
Length of add-on payment period	At least two years (until sufficient rate-setting data are available)	Two years
Is the new drug included in the PPS payment bundle at the end of the add-on payment period?	Yes	Yes
Is the PPS base rate updated at the end of add-on payment period?	Yes	No

Note: ESRD (end-stage renal disease), PPS (prospective payment system), TDAPA (transitional drug add-on payment adjustment), ASP (average sales price).
*In 2016, CMS set payment based on 106 percent of each drug's ASP. As of 2020, CMS sets payment based on 100 percent of each drug's ASP. To date, no drugs have qualified under either TDAPA policy.

Source: MedPAC analysis of final ESRD payment rules for 2016, 2019, and 2020.

the TDAPA period ends, CMS includes the drug in the PPS payment bundle (by adding a new functional category or modifying an existing one) and adjusts the PPS base rate, if appropriate, to reflect changes to the functional categories.⁴ To date, no new ESRD-related injectable drug has qualified under this TDAPA policy.

TDAPA policy for new ESRD drugs in an existing ESRD functional category

In the 2019 ESRD PPS final rule, CMS made two important changes to the TDAPA policy that expanded the types of drugs that would be eligible for the add-on payment. First, it expanded the TDAPA to allow add-on payments for all new ESRD injectable products (including generic drugs and biosimilars) that are in an existing ESRD-related functional category and approved by the Food and Drug Administration (FDA) on or after January 1, 2020. Second, CMS extended the TDAPA to allow

add-on payments for functional categories of drugs that were, before 2011, paid under the prior ESRD payment system's prospective payment—the composite rate. In other words, the expanded TDAPA policy would make an add-on payment for any new ESRD-related product for two years, even for a new drug with a functional equivalent already included in the payment bundle.⁵ After two years, CMS will include the drug in the PPS payment bundle but will make no modifications to the ESRD PPS base payment rate because there would be no changes to the functional categories. Once included in the ESRD PPS payment bundle, new products considered to be composite rate drugs would not be eligible for an outlier payment, but other new drugs would be eligible for outlier payments. According to CMS, the expanded policy is intended “to promote innovation and bring more high-value drugs to market” (Centers for Medicare & Medicaid Services 2018).

Medicare does not apply substantial clinical improvement criteria to determine a drug's eligibility to receive a TDAPA

CMS explicitly elected not to include substantial clinical improvement criteria to determine whether a new dialysis product receives a transitional drug add-on payment adjustment (TDAPA), stating that (1) its policy will provide an opportunity for new drugs to compete with other similar drugs in the market, which could result in lower prices for all drugs, and (2) the effectiveness of drugs can depend on age, gender, race, genetic predisposition, and comorbidities (Centers for Medicare & Medicaid Services 2018). With respect to paying a TDAPA for biosimilars, the

agency explained that although biosimilar products do not offer a new treatment method, the agency will pay a TDAPA for these products because their exclusion “would disadvantage this sector of biological products in a space where we are trying to support technological innovation.” According to the agency, “While the products [biosimilars] themselves may not be innovative, CMS believes that the technology used to develop the products is sufficiently new and innovative to warrant a TDAPA payment at this time” (Centers for Medicare & Medicaid Services 2019). ■

In response to concerns from stakeholders about the broad nature of the 2019 TDAPA policy expansion, CMS refined the TDAPA eligibility criteria in the rule-making process for the 2020 ESRD PPS, excluding drugs in an ESRD functional category from receiving an add-on payment if the agency considers them to be “not truly innovative,” based on FDA approval pathways (Centers for Medicare & Medicaid Services 2019). Under CMS’s finalized policy, the following new ESRD drugs in an existing functional category are not eligible for a TDAPA:

- generic drugs (i.e., drugs that the FDA approves under section 505(j) of the Federal Food, Drug, and Cosmetic Act) and
- new drugs approved for a new dosage form (e.g., pill size, time-release forms, chewable or effervescent pills); new drugs approved for a new formulation (e.g., new inactive ingredient); new approved drugs that were previously marketed without a new drug application (NDA); new approved drugs that changed from prescription to over the counter, among others. CMS would identify these drugs using the NDA classification code assigned by the FDA.⁶

Under CMS’s finalized policy, new products in an existing ESRD functional category that are eligible for the TDAPA include products that contain a new molecular entity, a

new active ingredient, or a new combination of drugs involving two or more active ingredients (for which one ingredient is a new molecular entity). As described in the text box on TDAPA eligibility criteria, in both the 2019 and 2020 rule-making process, CMS opted not to apply substantial clinical improvement criteria to determine a drug’s eligibility to receive a TDAPA.

Eliminating the TDAPA for new drugs in an existing ESRD functional category

Under current policy, for new ESRD drugs in an existing functional category, CMS does not reduce either the TDAPA payment or the base rate even though the cost of providing all drugs in a given functional category is included in the base rate. CMS elected not to account for the duplicative payment when expanding the TDAPA policy in 2019 and 2020, stating that the policy is temporary and not duplicative because, at the end of the two-year period, there is no additional money added to the base rate for those drugs in an existing functional category.

However, during the two-year period, Medicare effectively pays dialysis facilities twice for a drug in an existing functional category by paying separately for the new drug under the TDAPA while also including payment for

one or more drugs with a similar purpose or use in the ESRD PPS base rate. The TDAPA's ASP-based payment, which Medicare pays according to the number of units administered, creates incentives for potential overuse of drugs. Providers realize greater profits from larger doses than small doses of the TDAPA product (as long as Medicare's payment rate exceeds providers' costs). In addition, ASP-based payments provide no incentive for drug manufacturers to constrain the prices of new ESRD drugs. Further, by paying separately for new drugs in an existing functional category, Medicare misses an opportunity to encourage price competition among therapeutically similar drugs in the payment bundle.

Eliminating the TDAPA for new drugs in an existing ESRD functional category already included in the payment bundle would preserve the structure of the ESRD PPS by not unbundling services already covered under the PPS, create pressure for drug manufacturers to constrain the prices for new and existing ESRD drugs, and maximize price competition among therapeutically similar drugs in the payment bundle (Medicare Payment Advisory Commission 2019a, Medicare Payment Advisory Commission 2018). (The TDAPA for drugs not in an existing ESRD functional category would remain unchanged.)

By eliminating the TDAPA, no additional payments would be made for new drugs in an existing functional category at market entry because payment is already included in the payment bundle. There would be no concurrent update to the base rate after a new drug in an existing ESRD functional category is introduced and included in the PPS payment bundle. This policy would be consistent with the TDAPA policy that CMS implemented between 2016 and 2019.

As new products are added to the bundle and diffused into medical practice, there may be a need for rebasing to keep Medicare payments aligned with providers' costs. For example, the Congress mandated that the Secretary rebase the ESRD PPS base payment rate in 2014 to account for the decline in the use of dialysis drugs covered under the bundle.⁷ The Commission's annual payment adequacy analysis can help inform policymakers about the alignment of Medicare's payments to providers' costs. Our payment adequacy analysis also tracks dialysis drug use and changes in patients' outcomes over time.

Some stakeholders have raised concerns that access to new drugs in an ESRD functional category would be impeded

without a TDAPA and that not updating the base rate to account for new drugs would dampen drug manufacturers' investment in developing new ESRD drugs. However, under the ESRD PPS, beneficiaries appear to have good access to new products that are in an ESRD functional category. For example, in 2015, epoetin beta, an erythropoietin-stimulating biologic, was introduced to the U.S. market. CMS included the biologic in the ESRD PPS payment bundle; facilities did not receive a TDAPA for this product. Nevertheless, by the end of 2015, nearly one-quarter of dialysis beneficiaries had received this new biologic. One of the two large dialysis organizations (Fresenius) switched about 70 percent of its patients to the new biologic within one year after the product's market entry. Thus, including the new biologic in the payment bundle (without any TDAPA) resulted in increased competition and efficiencies. The Commission's analysis of this company's cost reports submitted to CMS showed that its ESA cost per treatment declined between 2015 and 2016. Further, there is no indication that beneficiary quality of care was affected by the treatment change.

There is concern that use of new ESRD drugs may be constrained by long-term contracts that some dialysis organizations have with drug manufacturers.⁸ However, under the ESRD PPS, the use of anemia and vitamin D drugs has shifted over time (Medicare Payment Advisory Commission 2017). Although some dialysis organizations have long-term contracts with particular drug vendors, the Medicare program should not expect the existence of such contracts to be an obstacle to beneficiaries receiving new treatments if those are better for the patient.

Some stakeholders have also asserted that it is not appropriate to assume that the base rate is sufficient to support new drugs that represent a clinical improvement. However, in the Commission's view, paying a TDAPA for new drugs in an existing ESRD functional category—irrespective of whether they meet a substantial clinical improvement standard—would undermine the competitive forces within the PPS payment bundle because the add-on would fail to create pressure on drug manufacturers to constrain prices for new and existing ESRD drugs.

An important goal of the ESRD PPS is to give dialysis facilities an incentive to provide ESRD-related items and services as efficiently as possible. This goal is best achieved by relying on the ESRD bundle to the greatest extent possible when determining payment amounts. Bundled payment encourages judicious consideration of

the items and services provided to patients. Paying the TDAPA for two years for new ESRD drugs in an existing functional category is duplicative of the payment already made as part of the ESRD bundle. Instead, including all ESRD drugs in an existing functional category (and thus with a similar function) in the bundle would foster competition for these products and generates pressure to constrain prices.

RECOMMENDATION 7-1

The Congress should direct the Secretary to eliminate the end-stage renal disease prospective payment system’s transitional drug add-on payment adjustment for new drugs in an existing end-stage renal disease functional category.

RATIONALE 7-1

This recommendation would eliminate the TDAPA for new ESRD drugs included in an existing ESRD functional category, which is consistent with CMS’s policy between 2016 and 2019. The recommendation would maintain the structure of the ESRD PPS by continuing to bundle services covered under the PPS and would reduce incentives for high launch prices of new drugs. This recommendation would also prevent duplicative payments for new drugs for which payment is already included in the ESRD bundle.

IMPLICATIONS 7-1

Spending

- This recommendation is estimated to decrease program spending by \$250 million to \$750 million over one year and by \$1 billion to \$5 billion over five years relative to current policy.

Beneficiaries and providers

- We do not anticipate any negative effects on beneficiary access to care. This recommendation would generate savings for beneficiaries through lower cost sharing and would reduce future payments to dialysis facilities without affecting dialysis facilities’ willingness and ability to care for beneficiaries.

Current payment for low-volume and rural dialysis facilities

The ESRD PPS includes a payment adjustment for facilities with low treatment volume and a separate

adjustment for facilities located in rural locations. Facilities with low treatment volume receive a significant upward payment adjustment regardless of their proximity to other providers; some facilities receive a low-volume adjustment even if they are located in close proximity to another dialysis provider and are thus not critical to maintaining access to care. At the same time, Medicare makes an adjustment for rural facilities regardless of the number of treatments they provide. Yet dialysis treatment volume is highly correlated with dialysis facilities’ costs. The greater the facility’s service volume, the lower its costs per treatment. Some rural facilities thus receive an upward adjustment to their payments even when they realize significant economies of scale. Indeed, after controlling for treatment volume, the difference in the cost per treatment between urban and rural facilities narrows considerably.

Current payment adjustment for low-volume facilities

The Medicare Improvements for Patients and Providers Act of 2008 (MIPPA) required the ESRD PPS to include “a payment adjustment that reflects the extent to which costs incurred by low-volume facilities (as defined by the Secretary) in furnishing renal dialysis services exceed the costs incurred by other facilities in furnishing such services.” CMS used regression analyses to empirically determine the magnitude of the adjustment.

Between 2011 and 2015, per regulation, CMS defined a low-volume facility as one that provided fewer than 4,000 total treatments in each of the three years before the payment year. For these years, a facility’s total treatment volume was equal to the sum of (1) the treatments furnished by the facility in question and (2) the treatments furnished by other facilities under common ownership that were within 25 road miles of the facility in question. However, the agency exempted facilities that were certified for Medicare participation as of December 31, 2010, from the distance requirement between the facilities that received the low-volume payment adjustment (LVPA) and the next closest facility (the so-called “grandfather” provision).

In our March 2014 report, we stated that only the low-volume ESRD facilities necessary to maintain access—those located in isolated areas—should receive enhanced payment, and recommended that the Congress direct the Secretary to redesign the LVPA to consider a facility’s distance to the nearest facility regardless of ownership

CMS requires facilities to attest to their qualification for the low-volume payment adjustment

CMS requires facilities to attest that they qualify for the low-volume payment adjustment (LVPA), including the total treatment volume in the three preceding years.⁹ At the time of attestation, cost report data is available only for the first two of the three years preceding the payment year. Attestation is necessary because some of the information the Medicare administrative contractors (MACs) need to assess a facility's eligibility—in particular a dialysis facility's cost reports for the year immediately preceding the payment year—may be unavailable to the MACs until several months after the payment year begins.¹⁰

Only after the dialysis facility has submitted its attestation and its designated MAC has verified that the facility meets the eligibility criteria will a facility begin to receive the LVPA. According to the Government Accountability Office (GAO), in cases where the MACs cannot make a final eligibility determination at the beginning of the payment year, they conditionally approve LVPA eligibility. After the necessary information becomes available, the MACs are required

to reassess the dialysis facility's eligibility for the LVPA (Government Accountability Office 2013). If a MAC determines that a facility receiving the LVPA was ineligible, the MAC is expected to recoup all payments to that facility made under the LVPA within six months of that determination.

Determining LVPA eligibility is a passive process for CMS, in which dialysis facility attestations are reviewed by the MACs. Dialysis facilities must assess LVPA eligibility on their own and submit an attestation before CMS or one of the MACs considers a facility's eligibility for the LVPA. Both GAO and the Commission's analysis found that eligible facilities did not receive the LVPA. Under the original LVPA policy (that was in place between 2011 and 2015), GAO determined that 79 eligible facilities in 2011 did not receive the LVPA for any treatments. Under the current LVPA policy (in place as of 2016), the Commission found more than 100 facilities in 2017 that appeared to be eligible but did not receive the LVPA (based on publicly available information on each facility's ownership that is reported in CMS's cost reports and Dialysis Facility Compare file). ■

(Medicare Payment Advisory Commission 2014). In 2016, CMS revised the LVPA definition by:

- decreasing the geographic proximity criterion from 25 miles to 5 miles. For the purposes of determining eligibility, a facility's total treatment volume is equal to the sum of (1) the treatments furnished by the facility in question and (2) the treatments furnished by other facilities under common ownership that are within five road miles of the facility in question.
- applying the five-mile distance requirement to all facilities regardless of when a facility was certified for Medicare participation. CMS no longer exempts facilities that were certified before 2011 from the distance requirement.

The 2016 changes did not alter the volume threshold; a low-volume facility is still defined as one that provides fewer than 4,000 treatments (Medicare and non-Medicare) in each of the 3 years before the payment year and has not opened, closed, or received a new provider number due to a change in ownership during the 3-year period.¹¹ As described in the text box on qualification for the LVPA, to establish eligibility, a facility must provide an attestation statement to its designated Medicare administrative contractor (MAC), which is responsible for verifying that the facility has met the eligibility criteria.

Because eligibility for the LVPA requires fewer than 4,000 treatments in each of the 3 years before the payment year, a facility could have an incentive to avoid providing 4,000 treatments or more in a given year

FIGURE 7-1

Higher volume facilities have lower cost per treatment

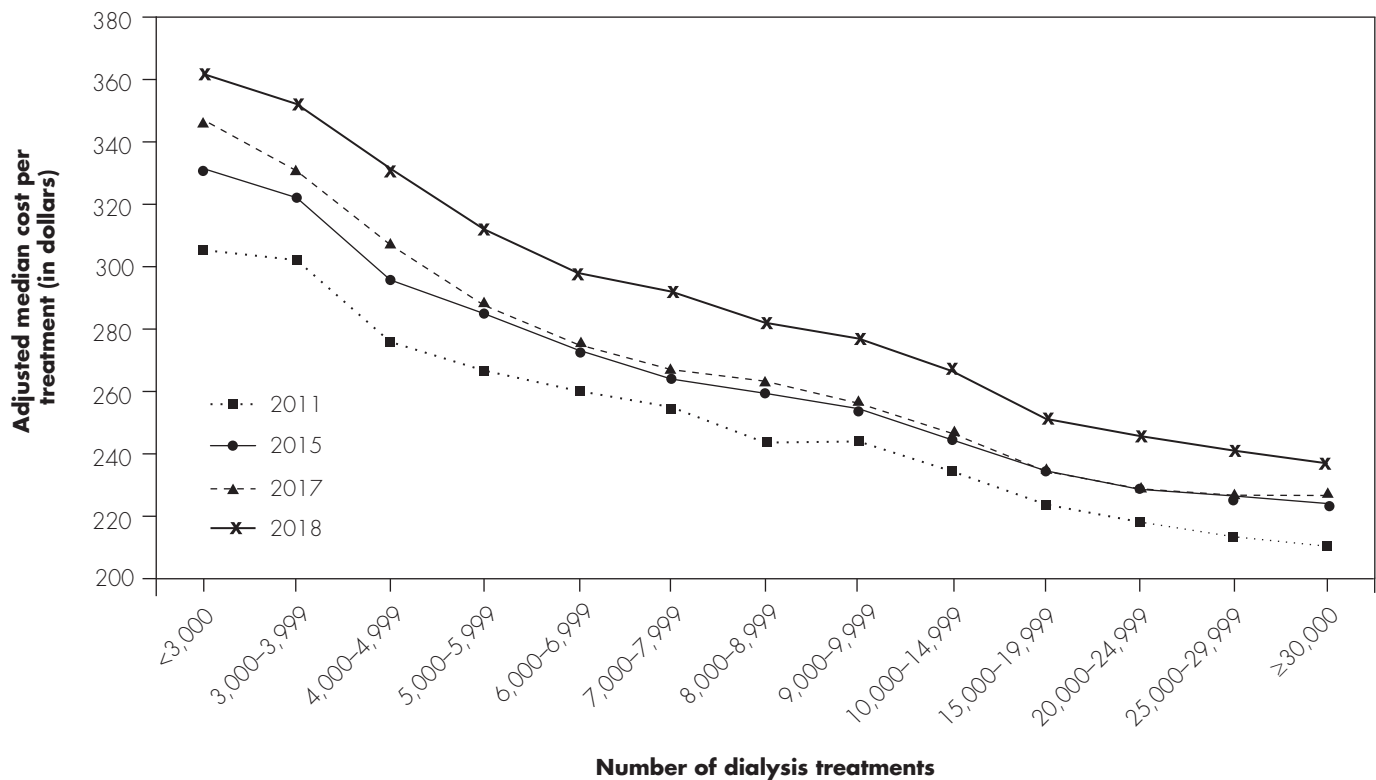

Note: Cost per treatment is adjusted to remove differences in the cost of labor. Dialysis treatments include those paid for by all sources (not just Medicare-paid treatments).
 Source: MedPAC analysis of cost reports submitted by freestanding dialysis facilities to CMS and the end-stage renal disease wage index files.

(Government Accountability Office 2013). In addition, the 4,000-treatment cut-off for LVPA eligibility leaves many facilities with comparatively low treatment volume without an adjustment for their higher average costs per treatment.¹² As shown in Figure 7-1, facilities providing 4,000 to 5,999 treatments per year also have relatively high average treatment costs, although not as high as facilities furnishing under 4,000 treatments per year.

LVPA freestanding facilities incur substantially higher costs per treatment compared with all freestanding facilities.¹³ In 2017, the adjusted cost per treatment of LVPA freestanding facilities was about \$320 per treatment, 28 percent greater than the adjusted cost per treatment of the other freestanding facilities. Among LVPA facilities, costs did not substantially vary based on their proximity to the nearest facility. For example, LVPA freestanding

facilities located within five miles of the next facility incurred a median adjusted cost of \$324 per treatment, while LVPA facilities located more than five miles from the next facility incurred an adjusted cost of \$318 per treatment.

In 2017, 270 freestanding and 66 hospital-based facilities received the LVPA, which increased their base payment rate by 23.9 percent. Figure 7-2 shows that some facilities receiving the LVPA were located near other facilities, suggesting that they may not have been essential for ensuring access to care. For example, in 2017, among facilities receiving the LVPA, 40 percent were located within five miles of the next closest facility and 15 percent were located within one mile of the next closest facility (data not shown). These proximities reflect the LVPA’s design, which, for the purposes of determining a facility’s

**FIGURE
7-2**

Current design of LVPA includes facilities in close proximity to another facility and excludes some isolated low-volume facilities

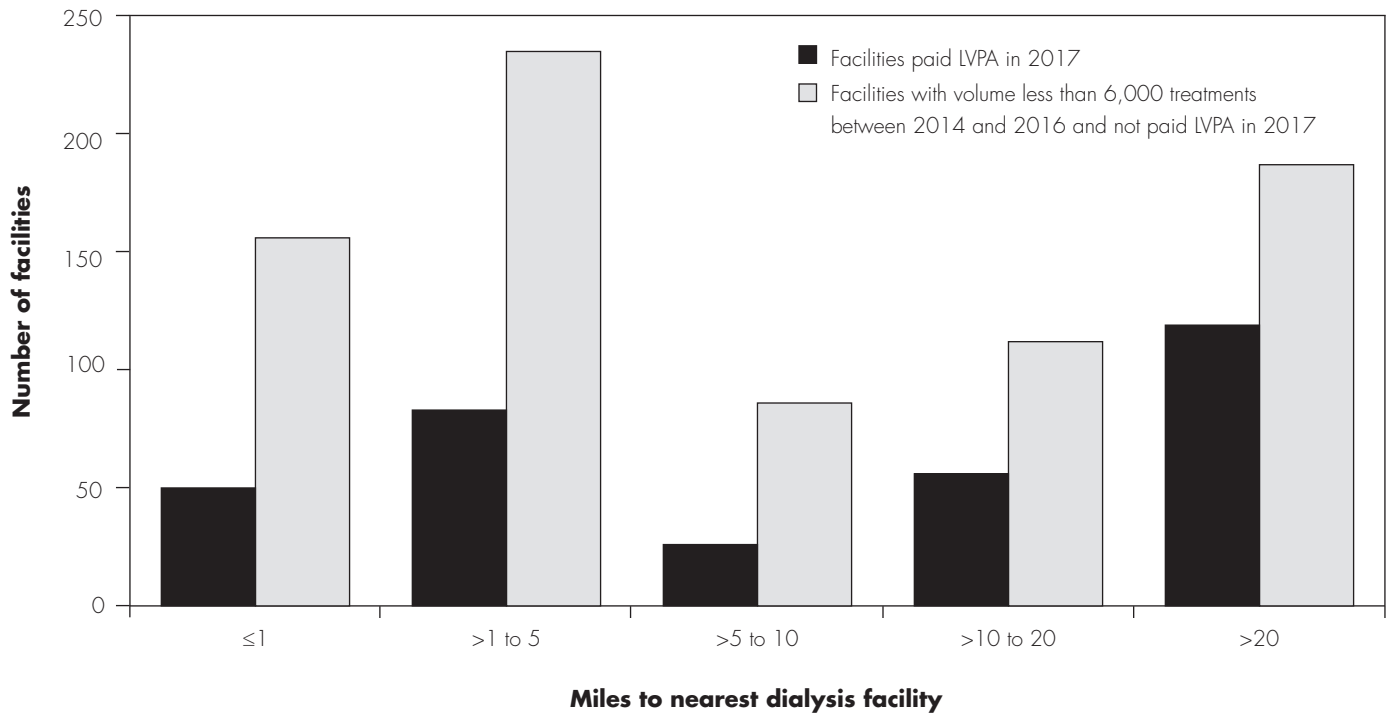

Note: LVPA (low-volume payment adjustment).

Source: MedPAC analysis of 2017 claims and 2017 cost reports submitted by dialysis facilities to CMS, Dialysis Facility Survey, and the Dialysis Facility Compare.

total treatments, excludes the treatments from facilities within five miles of the facility in question that are not under the same corporate ownership from the facility in question. In addition, Figure 7-2 shows that the current design of the LVPA does not include roughly 385 facilities that furnished fewer than 6,000 total treatments and were located more than 5 miles from the nearest facility.

Compared with all dialysis facilities, LVPA facilities in 2017 were more likely to be hospital based, rural, and not associated with the two largest dialysis organizations; each of these facility types was more likely to be farther from the next closest facility than its counterparts (freestanding, urban, and affiliated with the two largest dialysis organizations, respectively) (Table 7-3, p. 194). We found similar results when examining the proximity of low-volume facilities to other facilities in 2011 and 2012 (Medicare Payment Advisory Commission 2014).

Current payment adjustment for rural location

MIPPA gave the Secretary the authority to include (but did not require) a payment adjustment for facilities located in rural areas. In the rule-making process that implemented the ESRD PPS in 2011, the agency explained that a rural adjustment was not necessary because the impact of the new ESRD PPS was lower for rural facilities than urban facilities (and other subgroups) (Centers for Medicare & Medicaid Services 2015). Thus, from 2011 through 2015, the ESRD PPS did not include a rural payment adjustment.

Starting in 2016, CMS established a rural payment adjustment that increased the ESRD PPS base rate by 0.8 percent for facilities in rural areas. According to CMS, this change was adopted to address concerns from stakeholders about low-to-negative Medicare margins for rural facilities

**TABLE
7-3****Dialysis facilities receiving the LVPA were more likely to be hospital based, located in rural areas, and not associated with the two largest dialysis organizations, 2017**

	Facilities receiving the LVPA			All facilities		
	Percent of all LVPA facilities	Percent within 5 miles of nearest facility	Median miles to nearest facility	Percent of all facilities	Percent within 5 miles of nearest facility	Median miles to nearest facility
All facilities	100%	40%	11.6	100%	73%	2.2
Freestanding	81	45	7.5	95	74	2.2
Hospital based	19	22	27.0	5	63	2.3
Urban	49	60	3.4	82	82	1.9
Rural	51	20	23.9	18	31	18.7
LDO associated	62	45	7.2	73	72	2.3
Non LDO	38	31	19.9	27	11	1.9

Note: LVPA (low-volume payment adjustment), LDO (large dialysis organization). The number of facilities receiving the LVPA was 336; the number of all facilities was 7,089.

Source: MedPAC analysis of claims and cost reports submitted by dialysis facilities to CMS and the Dialysis Facility Compare file.

(Centers for Medicare & Medicaid Services 2015). For purposes of the rural payment adjustment, a rural area is defined as any area outside of an urban area.¹⁴ The rural adjustment does not impose a distance requirement between a facility that receives this adjustment and the

next closest facility and does not consider a rural facility's treatment volume. In 2017, 1,257 freestanding and hospital-based facilities were located in rural areas and thus received the 0.8 percent rural adjustment.

**TABLE
7-4****Adjusted cost per treatment is similar between urban and rural facilities with comparable treatment volume, 2017**

Annual number of dialysis treatments	Urban	Rural	Ratio of adjusted cost per treatment: urban to rural facilities
<4,000	\$337	\$337	1.00
4,000-4,999	310	309	1.00
5,000-5,999	296	289	1.02
6,000-6,999	282	280	1.01
7,000-7,999	271	273	0.99
8,000-8,999	263	270	0.98
9,000-9,999	259	256	1.01
10,000-14,999	248	256	0.97
≥15,000	232	240	0.97

Note: Cost per treatment is adjusted to remove differences in the cost of labor. "Dialysis treatments" includes those paid for by all sources (not just Medicare-paid treatments). Analysis is based on freestanding dialysis facilities.

Source: MedPAC analysis of 2017 cost reports submitted by freestanding dialysis facilities to CMS.

**FIGURE
7-3**

Current design of rural payment adjustment factor includes facilities in close proximity to another facility and facilities that are not low volume

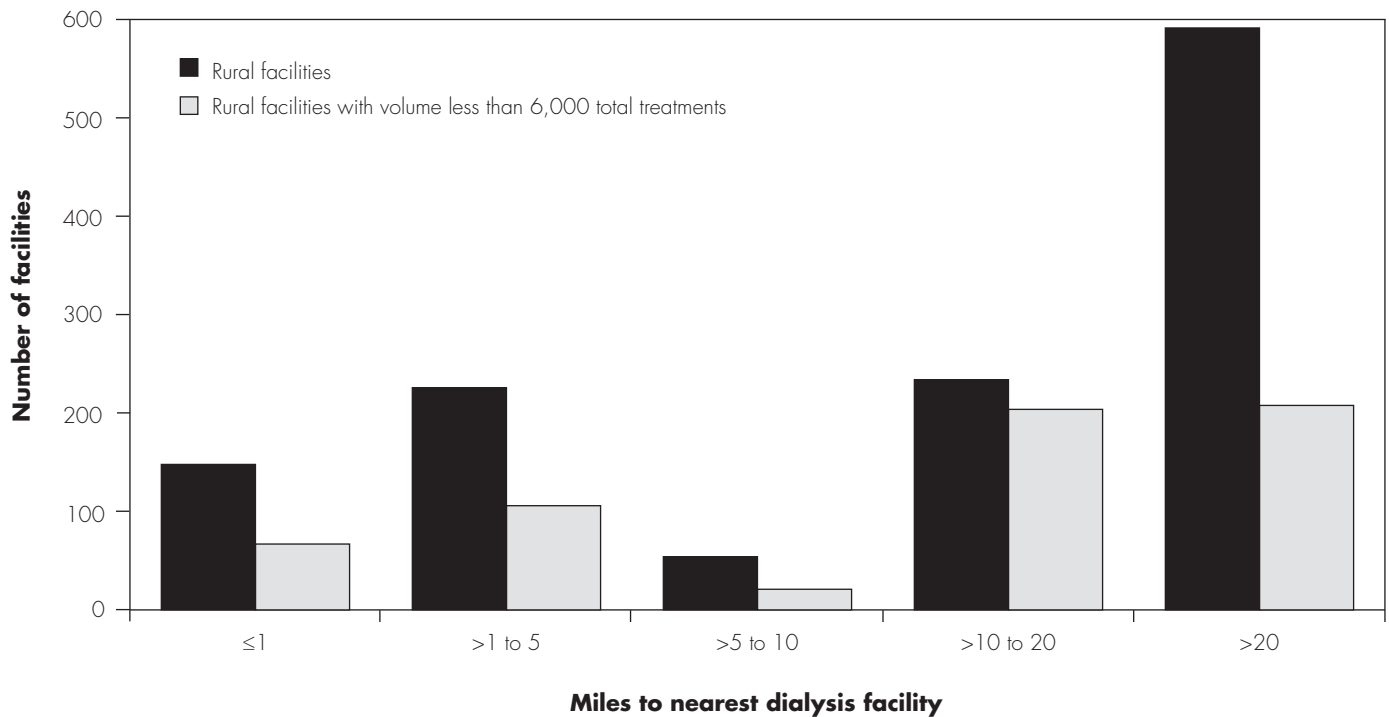

Source: MedPAC analysis of 2017 claims and 2017 cost reports submitted by dialysis facilities to CMS, the Dialysis Facility Survey, and the Dialysis Facility Compare file.

In our comment letter on CMS’s proposal to introduce the separate rural adjustment in 2016, the Commission urged the agency to design a single payment adjustment that targets low-volume isolated providers instead of two separate adjustments for low volume and rural location (Medicare Payment Advisory Commission 2015). The Commission’s analyses have found differences overall in the adjusted cost per treatment for rural and urban facilities (about \$270 per treatment versus nearly \$250 per treatment, respectively, in 2017); however, those differences generally are explained by differences between rural and urban facilities in total treatment volume. As shown in Table 7-4, the adjusted cost per treatment is roughly equivalent in rural and urban facilities with similar treatment volume. The 2017 aggregate Medicare margin follows a similar trend: Urban facilities had higher margins than rural facilities (1.3 percent versus –5.1 percent). However, after controlling for treatment volume,

the gap between urban and rural facilities narrows (data not shown).

In 2017, high-volume rural facilities (which represent about half of all rural facilities) received the 0.8 percent rural adjustment despite having adjusted costs per treatment that were similar to their high-volume urban counterparts (Table 7-4). In addition, 30 percent of rural facilities were within five miles of the next closest facility (Figure 7-3).

Improving the adequacy of payments for low-volume and isolated facilities

The design of the LVPA and rural payment adjustment are not consistent with the Commission’s principles guiding special payments to rural providers (see text box on

**FIGURE
7-4**

A new LVI adjustment would better target payments to low-volume, isolated dialysis facilities

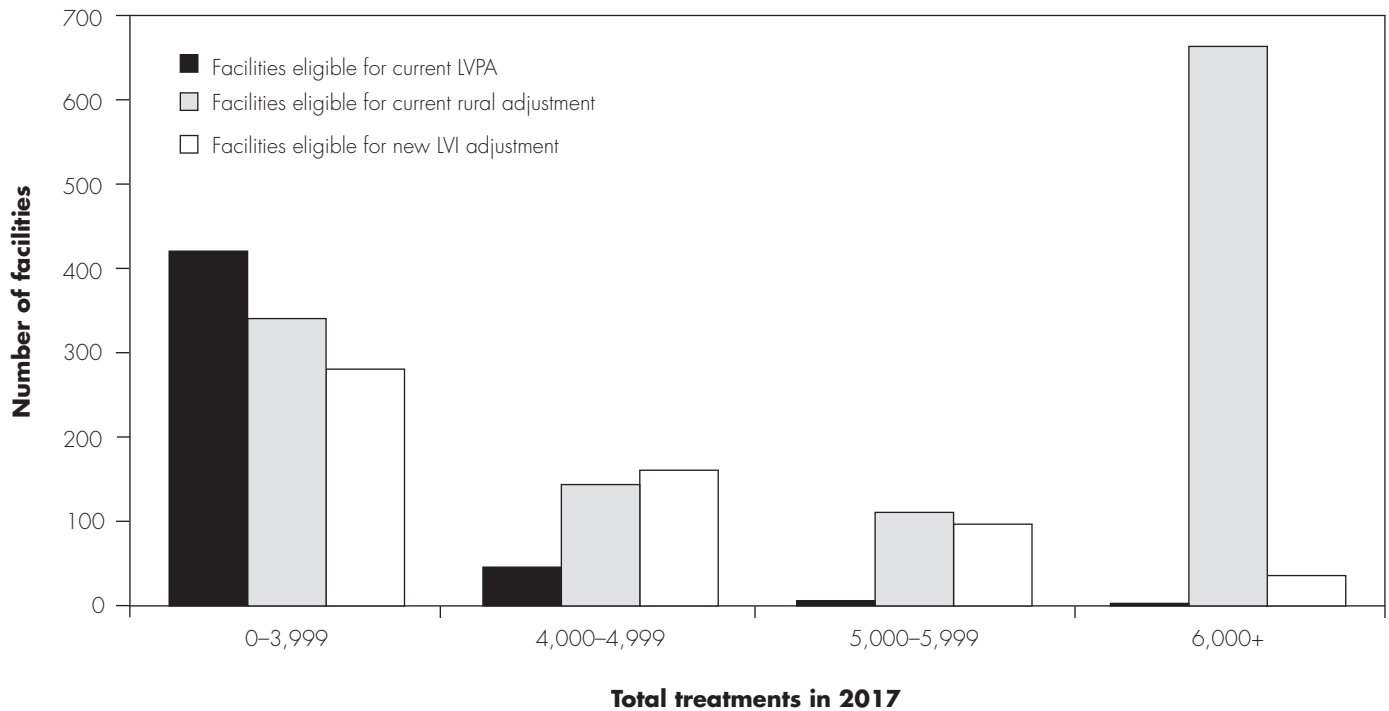

Note: LVI (low-volume and isolated), LVPA (low-volume payment adjustment). Analysis includes freestanding and hospital-based facilities. Eligibility for the LVPA and the LVI adjustment is based on total treatment volume between 2014 and 2016, the three years before the 2017 payment year in question. In 2017, some LVPA-eligible facilities provided more than 4,000 treatments, and some LVI-eligible facilities provided more than 6,000 treatments.

Source: MedPAC analysis of claims submitted by freestanding and hospital-based dialysis facilities and cost reports submitted by freestanding dialysis facilities to CMS, the ESRD Facility Survey, and the Dialysis Facility Compare file.

evaluating rural payments). The LVPA does not ensure that only isolated facilities receive the payment adjustment. For example, two facilities not under common ownership could be located in close proximity (e.g., within five miles of one another) and receive the 23.9 percent LVPA to their base rate. Further, there is no distance criterion or volume criterion required for a rural facility to receive the 0.8 percent increase to its base payment rate.

Consistent with the Commission’s principles, an adjustment that serves to preserve access to dialysis should focus on isolated *and* low-volume facilities. Neither the LVPA, which increases payment for facilities that are located within five miles of another facility, nor the rural adjustment, which increases payment for high-volume rural facilities, ensures access to dialysis care or spends program funds wisely.

In addition, isolated dialysis facilities, which we define as facilities located more than five miles from the next facility, vary in the number of treatments provided such that isolated facilities exist almost uniformly across all categories of facility treatment volume. For example, in 2017, nearly 30 percent of freestanding and hospital-based dialysis facilities located more than 5 miles from the next facility furnished more than 10,000 treatments.

A single payment adjustment that considers both a facility’s distance to the nearest facility and its treatment volume would eliminate extra payments to low-volume facilities in close proximity to another facility and to high-volume rural facilities and instead would target extra payments to low-volume and isolated facilities. A combined low-volume and isolated (LVI) adjustment would require the facility to be isolated and to have a low treatment volume. For example, CMS could use a distance

Guiding principles to evaluate rural special payments

Under the prospective payment system (PPS) for end-stage renal disease (ESRD), low-volume and rural adjustments are not consistent with the Commission's principles regarding Medicare payment policy for rural providers, nor with expectations regarding rural beneficiaries' access to care and rural providers' quality of care (Medicare Payment Advisory Commission 2012). The Commission stated the following principles in our June 2012 report to the Congress:

- Payments should be targeted toward low-volume, isolated providers—that is, providers that have low patient volume and are at a distance from other providers. Distance is required because supporting

two neighboring providers that both struggle with low volume can discourage mergers that could lead to lower cost and higher quality care.

- The magnitude of special rural payment adjustments should be empirically justified—that is, the payments should increase to the extent that factors beyond the providers' control increase their costs.
- Rural payment adjustments should be designed in ways that encourage cost control on the part of providers. Fixed add-on payments generally provide a greater incentive for cost control than cost-based payments. ■

of five miles to the nearest facility, the mileage threshold used for the LVPA. (Policymakers could consider using a different mileage threshold as long as it did not affect beneficiaries' access to care.) At the same time, to improve on the current cliff effect exhibited by the LVPA (which gives facilities an incentive to limit services to avoid reaching the 4,000-treatment threshold), CMS could apply the low-volume criterion using a few approaches. One method is to use a continuous function to determine the adjustment size. Using another method, the Commission modeled a categorical approach with three levels of low volume. Either approach would reduce the all-or-nothing application of the LVPA and better match the higher cost per treatment for facilities with relatively low volume. We created the following levels of low volume for three mutually exclusive categories:

- **Category 1:** facilities with fewer than 4,000 treatments in each of the 3 years preceding the payment year;
- **Category 2:** facilities that had fewer than 5,000 treatments in each of the preceding 3 years (excluding Category 1); and
- **Category 3:** facilities that had fewer than 6,000 treatments in each of the preceding 3 years (excluding Categories 1 and 2).

Using 2017 data, Figure 7-4 shows how the illustrative LVI adjustment criteria contrast with the current LVPA and rural adjustment criteria by comparing the number of freestanding and hospital-based facilities eligible for either the LVPA or the rural adjustment with the number of facilities eligible for the LVI adjustment.¹⁵

Overall, in 2017, 575 facilities would have been eligible to receive the LVI adjustment, compared with 477 facilities eligible for the LVPA and 1,257 facilities eligible for the rural adjustment. Roughly half of facilities eligible for the LVPA and one-quarter of facilities eligible for the rural adjustment would receive the LVI adjustment. Figure 7-4 shows that the expanded categories under the LVI adjustment increase the number of isolated facilities providing between 4,000 and 5,999 treatments that would receive a low-volume adjustment. As seen earlier in Figure 7-1 (p. 192), facilities with treatment volumes between 4,000 and 5,999 also had relatively high cost per treatment.

Table 7-5 (p. 198) shows the number of eligible facilities (freestanding and hospital based) and the median adjusted cost per treatment (based only on freestanding facilities with cost report data) for each of the three LVI categories. Although the size of the LVI category adjustments would be empirically estimated, the median costs demonstrate

**TABLE
7-5**

Facilities eligible for LVI adjustment have higher costs than all other isolated facilities

	Number of dialysis facilities	Median adjusted cost per treatment
LVI Category 1	255	\$320
LVI Category 2	188	304
LVI Category 3	132	278
Reference group: All isolated facilities not receiving an LVI payment adjustment	1,899	250

Note: LVI (low-volume and isolated). LVI Category 1 comprises facilities with fewer than 4,000 treatments in each of the 3 years preceding the payment year. LVI Category 2 comprises facilities that had fewer than 5,000 treatments in each of the preceding 3 years (excluding LVI Category 1 facilities). LVI Category 3 comprises facilities that had fewer than 6,000 treatments in each of the preceding 3 years (excluding LVI Category 1 and LVI Category 2 facilities). Median cost per treatment is based only on freestanding facilities with cost report data and has been adjusted to account for local wage variation.

Source: MedPAC analysis of claims and cost reports submitted by dialysis facilities to CMS.

that the expanded low-volume categories have higher costs than other isolated facilities.

Effect of a low-volume and isolated adjustment on Medicare payments to dialysis facilities

To assess the effect of replacing the current low-volume and rural location adjustments with a single low-volume and isolated adjustment, we used a regression method based on a model previously developed by CMS to explain variation in treatment costs. Using a single facility-level regression model, we assessed the effect of substituting a single payment adjustment—the LVI adjustment—in place of the two adjustments for low volume and rural location that the ESRD PPS currently uses.

Model specification

Our single facility-level regression model uses freestanding dialysis facilities’ cost reports submitted to CMS, with the dependent variable equal to a facility’s 2017 average cost per treatment, which captures the cost of all services included in the PPS payment bundle, including drugs and laboratory services that were separately billable under the prior payment system. We estimated coefficients for the payment adjustment factors currently included in the ESRD PPS.

We chose a single facility-level regression approach instead of CMS’s two-regression approach out of concerns that multiplying coefficients from the facility-level and

patient-level regressions (with different bases) could diminish the accuracy of the combined coefficients (Medicare Payment Advisory Commission 2015). The text box outlines our concerns with CMS’s two-regression approach.

Our regression model includes freestanding facilities with cost data for 2017 (roughly 400 hospital-based facilities are excluded due to concerns about data validity).¹⁶ To improve the accuracy of regression results, we excluded facilities with outlier values for average cost per treatment (i.e., defined as having logged average treatment cost outside of two standard deviations from the mean). We include the same control variables (i.e., facility size, ownership type, and home dialysis training) as the ESRD PPS-estimating regression, with a few minor differences in definition (i.e., we differentiate between facilities providing 10,000 to 15,000 treatments and more than 15,000 treatments, and we collapsed independent and unknown ownership types). We include the same patient-level variables—age, body mass index, body surface area, comorbid conditions, and time since the onset of ESRD. We specify each set of these variables using the percent of treatment in each category.

The Commission’s model findings

As shown in Table 7-6 (p. 200), the current ESRD PPS adjustment values are 1.239 for the LVPA and 1.008 for rural location. (Payment adjustment values are applied

CMS's model specification may not accurately estimate payment adjustment factors

For the end-stage renal disease (ESRD) prospective payment system (PPS), CMS estimated the payment adjustment factors using a two-equation regression methodology. The agency conducted one regression at the facility level and used cost report data to calculate each facility's average treatment cost for the composite rate set of services, adjusted for differences in wages.¹⁷ CMS conducted the second regression at the patient level and used Medicare claims to calculate the average Medicare-allowable per patient payment amount for items and services that formerly were separately billable. Together, the composite rate services and former separately billable services make up the current ESRD bundle.

Each regression includes the same set of control variables and payment adjustment variables shown in Table 7-1 (p. 186) and estimates a coefficient for each payment adjustment variable.¹⁸ To combine the coefficients from the two regressions, for each adjustment, the coefficient from the composite rate model is multiplied by the share of composite rate service spending, and the coefficient from the former separately billable model is multiplied by the share of former separately billable service spending. The weighted coefficients from each regression are multiplied to derive the final coefficient.

Multiplying coefficients from the facility-level and patient-level regressions (with different bases) can

diminish the accuracy of the combined coefficients. Through various re-estimations of the payment adjustment amounts, the empirically determined lowest cost reference population for the age category variables has shifted from ages 45 to 59 in the proposed rule for the 2011 PPS to ages 60 to 69 in the final rule for the 2011 PPS and to ages 70 to 79 in the final rule for the 2016 PPS (Table 7-1, p. 186). We would expect the relative cost of dialysis treatment across age categories to remain roughly stable over time and are concerned that such shifts indicate that the estimated factors are highly sensitive to the model's specification and that the model lacks robustness. The two-equation approach might contribute to the instability of these results.

The Commission advised CMS to develop payment adjustment factors using a single-equation methodology that accounts for variation in the cost of providing the full PPS payment bundle (Medicare Payment Advisory Commission 2015). Given the availability since 2011 of cost data for the full PPS payment bundle, it is no longer necessary to use pre-2011 service categories when developing the adjustment factors. The distribution of average treatment cost across facilities is quite likely to be different from the distribution of payments for separately billable services across patients, and combining the two factors estimated on unrelated distributions may not accurately reflect cost variation for the payment unit, a dialysis treatment. ■

as multipliers to the ESRD PPS base rate; that is, a 1.239 adjustment value would increase the base rate by 23.9 percent.) The Commission's regression analysis estimated payment adjustment values of 1.319 for the LVPA and 1.010 for rural location.¹⁹

Differences between our results and the current ESRD PPS adjustment values could be due to using different years of data or to differences in the regression specification. As described in the text box on model specifications, CMS

used a two-equation regression methodology to derive the ESRD PPS payment adjustments:

- a facility-level regression model that used 2012 and 2013 cost reports submitted by dialysis facilities to CMS, with the dependent variable equal to the average cost per treatment for composite rate services.
- a patient-level regression model that used 2012 and 2013 dialysis facility claims, with the dependent

**TABLE
7-6**

LVPA and rural location adjustment values in the current ESRD PPS and based on the Commission’s regression analysis

	ESRD PPS values			MedPAC regression values
	Facility-level regression of composite rate services	Patient-level regression of separately billable services	Combined regression results, all ESRD bundle services	Facility-level regression of all ESRD bundle services
LVPA	1.368	0.955	1.239	1.319
Rural location	1.015	0.978	1.008	1.010
Share of treatment cost	80.8%	19.2%	100%	100%

Note: LVPA (low-volume payment adjustment), ESRD (end-stage renal disease), PPS (prospective payment system). CMS derived the ESRD PPS adjustment values by combining the results of (1) a facility-level regression model that used 2012 and 2013 dialysis facility cost reports, with the dependent variable equal to the average cost per treatment for composite rate services, and (2) a patient-level regression model that used 2012 and 2013 dialysis facility claims, with the dependent variable equal to the estimated average payment per patient for dialysis-related drugs and laboratory services. The Commission estimated payment adjustment values based on a single regression that uses 2017 cost report and claims data, with the dependent variable equal to the average cost of ESRD bundle services. The Commission’s regression results are significant at $p < .0001$ level for the LVPA and $p < .05$ level for rural location, are based on a regression including 5,151 freestanding facilities, and have an R^2 of 0.3816. Our estimate of the LVPA adjustment is higher than the ESRD PPS factor in part because the ESRD PPS factor is adjusted by the ratio of low volume to other volume category factors, whereas our estimate incorporates other volume category factors into the base rate.

Source: MedPAC analysis of calendar year 2016 final rule, 2017 cost reports submitted by freestanding dialysis facilities to CMS, and dialysis claims.

variable equal to the estimated average payment per patient for dialysis-related drugs and laboratory services.

To calculate the value of each payment adjustment, CMS combined the facility-level regression results with the patient-level regression results by weighting factors from each regression by the share of treatment cost for each set of services (e.g., composite rate share (1.015×0.808) + separately billable share $(0.978 \times 0.192) = 1.008$ for the rural payment adjustment).

By contrast, the Commission estimated the payment adjustment values using a single-equation regression, with the dependent variable equal to the average cost of all ESRD bundle services and 2017 cost report and claims data.

The rural location variable in our LVPA and rural regression model (Table 7-6) was found to be statistically significant, meaning that accounting for other factors in the model, rural location is associated with higher treatment costs. Despite the statistical significance of this result, an adjustment for all rural facilities, including those that are high volume or near another facility, would

not meet the Commission’s other two rural payment principles: Rural payment adjustment should be targeted to low-volume and isolated facilities and should include a way to encourage cost control. We note that the ESRD PPS regression also includes control variables (e.g., additional facility-size categories and organization of ownership) that serve to accurately specify the size of the payment adjustment factors (i.e., the coefficients for payment adjustment variables are more accurately estimated when controlling for other factors that affect average treatment cost). Regression coefficients for control variables may be statistically significant, yet those control variables do not affect payment.²⁰ For example, facilities associated with large dialysis organizations (LDOs) or other chain organizations were associated with having higher costs than facilities with independent or unknown ownership (statistically significant in our regression results), but LDOs and other chain organizations do not receive a payment increase due to their ownership status.²¹ The goal of this policy is to focus payment adjustments on those facilities most essential to ensure access to care, and thus, in our view, a payment adjustment for rural location is not warranted for facilities that are not low volume and

**TABLE
7-7**

Estimated LVI payment adjustment values decrease as total treatment volume increases

MedPAC regression

Facility level, all ESRD bundle services

LVI Category 1	1.317
LVI Category 2	1.267
LVI Category 3	1.189
Share of treatment cost	100%

Note: ESRD (end-stage renal disease), LVI (low-volume and isolated). LVI Category 1 comprises facilities with fewer than 4,000 treatments in each of the 3 years preceding the payment year. LVI Category 2 comprises facilities that had fewer than 5,000 treatments in each of the preceding 3 years (excluding LVI Category 1 facilities). LVI Category 3 comprises facilities that had fewer than 6,000 treatments in each of the preceding 3 years (excluding LVI Category 1 and LVI Category 2 facilities). MedPAC regression results are significant at $p < .0001$ level, are based on a regression including 5,151 freestanding facilities, and have an R^2 of 0.3840.

Source: MedPAC analysis of cost reports submitted by freestanding dialysis facilities to CMS and dialysis claims.

not isolated. However, given its statistical significance, rural location could be considered as an addition to the control variables in the ESRD PPS regression model.

Table 7-7 shows regression results for the LVI category adjustments. LVI Category 1 facilities, those with fewer than 4,000 treatments in each of the 3 prior years and farther than 5 miles from the nearest facility, would receive an adjustment of 1.317. LVI Category 2 facilities would receive an adjustment of 1.267, and LVI Category 3 facilities would receive an adjustment of 1.189. The relative size of the three LVI coefficients aligns with evidence showing that facilities providing the fewest treatments have higher average costs, and the statistical significance of each coefficient demonstrates the benefit of expanding the definition of low volume above 4,000 treatments for isolated facilities.

To assess the impact on facility payment rates of replacing the LVPA and rural location adjustments with the LVI category adjustments, we estimated the base rate and payment factors from each regression model and calculated the average facility payment rate based on each model. The impact on facilities depends on their eligibility for any LVI adjustment, the LVPA, and the rural location adjustment. Table 7-8 (p. 202) shows that most facilities meeting our low-volume and isolated criteria would have no change in payment or would receive a payment increase

(first three rows of the table), but facilities currently eligible for both the LVPA and rural location adjustment would see a small decrease (fourth row of the table), as the LVI Category 1 factor is smaller than the sum of the estimated the LVPA and rural location adjustment factors. The largest payment increases, 20 percent and 21 percent, would be for facilities that are newly eligible for the low-volume and isolated adjustment based on the expanded definition (i.e., facilities eligible for LVI Category 2 and Category 3 adjustments), depending on whether they are currently eligible for the rural location adjustment.

As shown in Table 7-8 (p. 202), facilities currently eligible for the LVPA, the rural location adjustment, or both but not eligible for the LVI adjustment would see a payment decrease. These facilities are located in a rural area and are not low volume, or they are low volume but located within five miles of another facility. A concern could be that LVPA-eligible facilities that are not isolated (and therefore are not LVI eligible) would receive a 22 percent or 23 percent payment decrease, depending on rural location. However, under the LVPA, Medicare currently subsidizes low-volume facilities that are near other facilities, in contrast to the goal of the LVI adjustment to support only low-volume facilities that are essential to maintain access to dialysis care and thereby improve the value of Medicare’s spending. Overall, we find that the payment changes caused by replacing the LVPA and rural

**TABLE
7-8**

Estimated impact of the Commission’s LVI adjustment on average Medicare payment rate for facilities of varying eligibility

Facilities’ eligibility to receive:

LVI adjustment	LVPA	Rural adjustment	Number of facilities	Estimated average Medicare payment change
Yes	No	No	136	21%
Yes	No	Yes	184	20
Yes	Yes	No	83	0
Yes	Yes	Yes	172	-1
No	No	Yes	867	-1
No	Yes	No	173	-22
No	Yes	Yes	49	-23
No	No	No	5,425	0

Note: LVI (low-volume and isolated), LVPA (low-volume payment adjustment). Estimated impact of LVI adjustment is based on the Commission’s number of facilities affected using data for all 7,089 freestanding and hospital-based facilities in 2017. Average payment change is based on the Commission’s estimates of the LVI adjustment, LVPA, and rural adjustment for 5,823 freestanding facilities.

Source: MedPAC analysis of cost reports and claims submitted by dialysis facilities to CMS.

adjustment with the LVI category adjustments generally align with the Commission’s principles that facilities with greater importance for maintaining access to services (those that are isolated) can receive a higher payment rate if such an increase is empirically justified, as demonstrated by our analysis.

Finally, we estimated the impact of switching from the current LVPA and rural adjustment factors to the LVI adjustment across various facility characteristics (e.g., urban/rural, large dialysis organization/other, for profit/nonprofit, freestanding/hospital based). We found that few facilities would experience a significant payment change under the LVI adjustment. Only 8 percent of facilities are affected, falling into one of three mutually exclusive categories: (1) were LVPA eligible but would not be LVI eligible, (2) were LVPA eligible and would be LVI eligible, or (3) were not LVPA eligible but would be LVI eligible. Moreover, a similar number of facilities would experience a significant payment increase or decrease (i.e., 320 facilities would experience a significant payment increase, 265 facilities would experience a significant payment decrease). Given the low share of facilities affected, we did not find a substantial impact for any of the subgroups of facilities we assessed.

Effects of a low-volume and isolated payment adjustment on beneficiaries’ access to high-quality care

To assess the potential impact of our illustrative LVI policy on quality, we used each facility’s total performance score that CMS calculated under the 2017 ESRD Quality Incentive Program (QIP). Beginning in 2012, outpatient dialysis payments are linked to the quality of care that facilities provide under the ESRD QIP. Under statutory provisions, the maximum payment reduction that CMS can apply to any facility is 2 percent. In 2017, facilities could receive a total performance score ranging from 0 (the lowest) to 100 (the highest) based on the following measures:

- clinical measures that assess vascular access among hemodialysis beneficiaries, dialysis adequacy, bloodstream infections, hospital readmission rates, and presence of hypercalcemia; and
- reporting measures that assess bone mineral metabolism and disease management, anemia management, and the facility’s compliance with administering the in-center hemodialysis Consumer Assessment of Healthcare Providers and Systems® survey on a twice-yearly basis.

Among all dialysis facilities (with 2017 QIP data), the QIP total performance score averaged 68.6. The score of facilities that would no longer receive the LVPA under the illustrative LVI policy was not statistically different from the score of the next closest facility (70.9 versus 69.3, respectively, using a paired t-test).

A separate concern involves the potential for predatory competition with low-volume and isolated providers. That is, would an LVI policy allow an organization with sufficient capital reserves to establish a new facility in close proximity to an LVI-eligible facility, thus rescinding the LVI eligibility and reducing Medicare payments to the existing facility in an attempt to put the facility out of business and capture the facility's patient population? In our view, the incentive to engage in such predatory competition could be limited by the generally negative Medicare margins of low-volume facilities (see March 2019 report findings for evidence that low-volume facilities tend to have lower margins) and the requirement to find a new medical director in an area that is likely to be rural (Medicare Payment Advisory Commission 2019b). Our review of new facility openings in 2017 corroborates this view: Just 7 of 302 new facilities opened within 5 miles of an LVPA-receiving facility and only 1 opened within 5 miles of a rural LVPA-receiving facility.

Under the current LVPA policy, an existing facility would not lose its low-volume payment adjustment (23.9 percent increase) if a competing facility opened within five miles of its location because proximity to another facility is considered only for facilities under common ownership. Under the LVI policy, eligible facilities would need to be located farther than five miles from the nearest facility regardless of ownership. To address predatory competition—a new dialysis facility opening within five miles of an existing LVI facility—policymakers could exempt the existing LVI facility from the five-mile distance criterion for a period of three years as long as it continues to meet the volume criteria (i.e., the existing low-volume facility would continue to receive the LVI adjustment for three years, despite being located within five miles of another facility). A three-year exemption from the distance criterion for the existing facility would ensure beneficiaries' access to care and promote competition between the existing and new facility to provide patient-centered high-quality care. At the end of the three-year "exemption" period, a facility would be required to meet both the distance and volume criteria to receive the LVI adjustment.

Policymakers could consider a continuous low-volume and isolated payment adjustment instead of a categorical approach

As an alternative to a payment adjustment using categorical variables, a continuous adjustment factor could apply the same eligibility criteria for facility isolation (i.e., no other facilities within 5 miles), but would replace the 3 low-volume categories with a single threshold: fewer than 7,000 treatments, for example, in each of the 3 years (2014, 2015, and 2016) preceding the payment year (2017). (We used a 7,000-treatment threshold to approximately align the facilities eligible for the LVI adjustment with those under the 3-category approach used in our model.)

We conducted a preliminary analysis to illustrate the impact of a continuous adjustment factor. For illustrative purposes, we specified a continuous factor by assigning it a value of 7,000 minus the average annual number of treatments across the preceding years for eligible facilities and a value of 0 for all other facilities. To estimate the marginal cost reduction for providing one additional treatment in eligible facilities if a continuous adjustment were in effect, we used the same regression model that was used to determine the LVI adjustment's effect.

Figure 7-5 (p. 204) shows that a continuous adjustment would have the benefit of smoothing the cliffs, or cut points, associated with categorical adjustments, under which an increase from LVI Category 1 (facilities with fewer than 4,000 treatments) to LVI Category 2 (facilities with between 4,000 and 4,999 treatments) decreases the payment adjustment from about 32 percent to 27 percent. Alternatively, adding more categories to the categorical adjustment could also limit the cliff effect.

A continuous adjustment might be more challenging to administer than a categorical approach. To determine the value of a facility's continuous adjustment, the facility would need to attest to whether the number of treatments provided in each of the three preceding years was lower than the 7,000-treatment threshold. Before the payment year, facilities would also need to provide CMS an estimate of the average annual number of treatments provided across the three years preceding the payment year (i.e., average of actual treatment volume for the first two years of this period and the projected treatment volume for the third year still in progress) and multiply that number by the continuous adjustment factor. This

FIGURE 7-5

Illustrative example comparing LVI categorical adjustment to LVI continuous adjustment

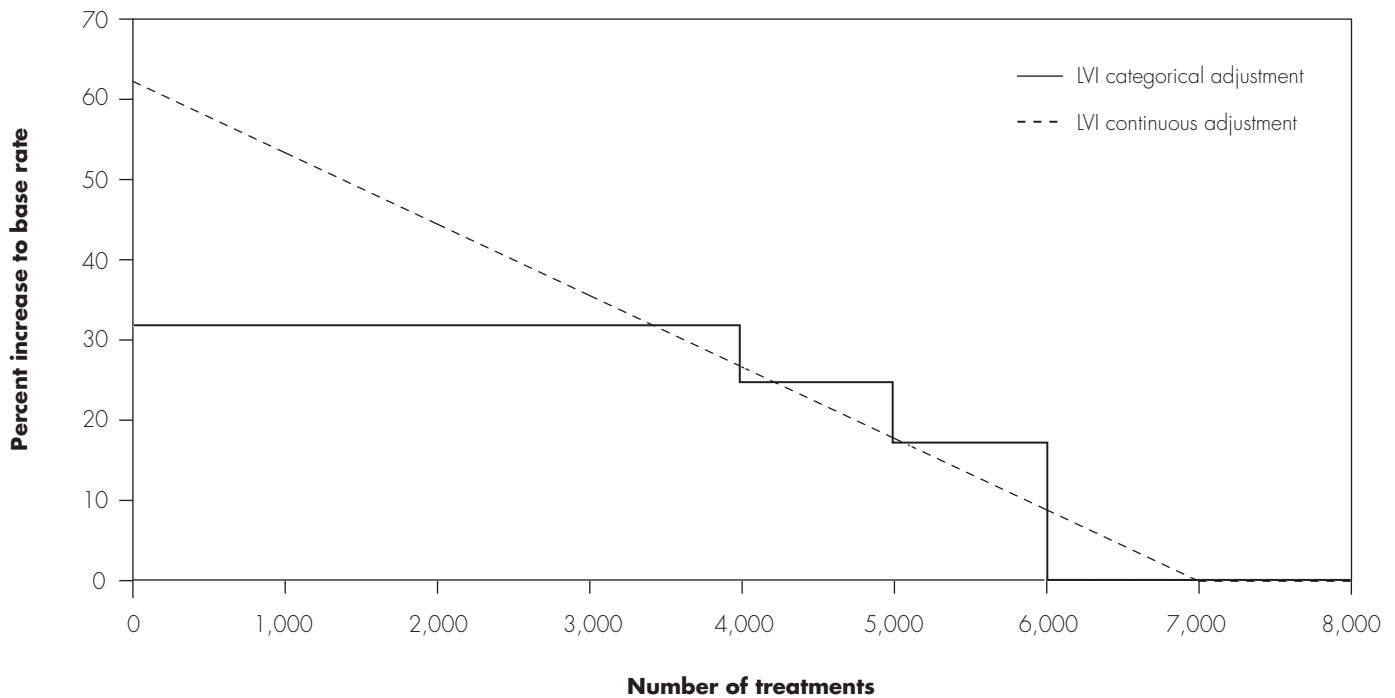

Note: LVI (low-volume and isolated).

Source: MedPAC analysis of cost reports submitted by freestanding dialysis facilities to CMS and dialysis claims.

process is slightly more complicated than determining a facility's categorical LVI adjustment (and current LVPA adjustment), which only requires facilities to check whether the number of treatments provided in each of the three preceding years is lower than a threshold. Because of these differences, providers could calculate and predict Medicare rates more easily under a categorical approach.

A continuous adjustment could provide greater accuracy than a categorical adjustment if it is calculated with the empirically determined number of maximum treatments using accurate dialysis cost report data (our analysis used a 7,000-treatment threshold for illustrative purposes only). One concern about using an adjustment with a complex design is that the quality of the underlying cost data may not be sufficient to support that level of accuracy. For example, facilities do not consistently report peritoneal dialysis treatments according to CMS guidelines. One week of peritoneal dialysis should be reported as three

hemodialysis-standardized (or equivalent) treatments; however, some facilities report according to the guideline and other facilities report seven daily peritoneal dialysis treatments per week. Some stakeholders advocate for fewer and less complicated adjustments in the ESRD PPS over concern that adjustments reduce the base rate, but those adjustments are paid out to facilities to the same extent they are accounted for in estimating the ESRD PPS. Policymakers should consider how to balance the accuracy of adjustments with the accuracy of the underlying data.

RECOMMENDATION 7-2

The Secretary should replace the current low-volume and rural payment adjustments in the end-stage renal disease prospective payment system with a single adjustment for dialysis facilities that are isolated and consistently have low volume, where low-volume criteria are empirically derived.

RATIONALE 7-2

The design of the current low-volume and rural payment adjustments does not align with the Commission's principles on payments to rural providers: Rural payment adjustments should target facilities that are critical for beneficiary access (meaning those that are both low volume and isolated), the magnitude of payment adjustments should be empirically derived, and the adjustments should encourage provider efficiency.

The current low-volume payment adjustment is applied to facilities that are located near another dialysis facility, does not account for the higher cost of facilities with volumes of 4,000 to 5,999 treatments per year, and uses a single all-or-nothing threshold. The rural adjustment applies to all facilities located in rural areas, regardless of their treatment volume or proximity to another facility. The recommendation would apply to facilities that are necessary to preserve access to care (both low volume and isolated), would better account for facilities with higher cost of treatment, and would mitigate the all-or-nothing application of the current low-volume adjustment. The low-volume and isolated adjustment in the recommendation could be implemented with a categorical or continuous approach. In either case, eligibility for the adjustment and size of the adjustment should be empirically derived.

IMPLICATIONS 7-2

Spending

- The recommendation is intended to be budget neutral with respect to current policy.

Beneficiaries and providers

- The recommendation enhances beneficiaries' access to care at isolated, low-volume facilities. It is not expected to affect providers' willingness or ability to serve beneficiaries. Based on our analysis, payments would increase for providers with lower treatment volumes that are not in close proximity to another facility but currently do not receive the low-volume payment adjustment. Payments would decrease for providers currently receiving the low-volume payment adjustment that are in close proximity to another facility and for providers currently receiving the rural adjustment but have higher volume or are in close proximity to another facility. ■

Endnotes

- 1 Before 2011, Medicare paid dialysis facilities a prospective payment, referred to as the composite rate, that covered services routinely required for dialysis treatment, including dialysis equipment and supplies, social services, nursing, dietary counseling and other clinical services, and certain laboratory tests and drugs. The composite rate payment bundle did not include certain commonly furnished Part B drugs, including erythropoietin-stimulating agents, iron, and vitamin D agents.
- 2 A separate method is used to calculate payments for pediatric dialysis beneficiaries (ages 17 and younger), who constitute less than 1 percent of all dialysis beneficiaries.
- 3 Wage index values vary geographically, tied to the Office of Management and Budget's core-based statistical areas. The wage index values used under the ESRD PPS are the inpatient PPS wage index values calculated without regard to geographic reclassifications and utilize pre-floor hospital data that are unadjusted for occupational mix.
- 4 Under the drug designation process that CMS established in 2016, new injectable drugs used to treat or manage a condition that are in an existing ESRD-related functional category are considered part of the PPS payment bundle and thus not eligible for a TDAPA.
- 5 Specifically, for drugs that fall within an existing functional category, the TDAPA ends two years from the effective date of the subregulatory billing guidance that begins the add-on payment.
- 6 Specifically, CMS is excluding from TDAPA eligibility those drugs approved by the FDA under Section 505(c) of the Food, Drug, and Cosmetic Act and new drugs that the FDA assigns an NDA classification code of Type 3, 5, 7, or 8; Type 3 in combination with Type 2 or Type 4; Type 5 in combination with Type 2; or Type 9 when the "parent NDA" is Type 3, 5, 7, or 8.
- 7 The rebasing in 2014 resulted in a reduction of the base payment rate by \$8.16 per treatment.
- 8 The specific terms included in the contracts between dialysis organizations and drug manufacturers are not public. However, we can obtain some information from the annual filings that publicly traded companies submit to the Securities and Exchange Commission. For example, in 2017, DaVita entered into a "Sourcing and Supply Agreement" with Amgen for both the oral and intravenous versions of calcimimetics and Epoprostenol, an agreement that concludes in 2022 (DaVita 2019). According to this public document, the contract requires DaVita to purchase Epoprostenol in amounts necessary to meet no less than 90 percent of the company's requirements for erythropoiesis-stimulating agents through the expiration of the contract.
- 9 This 3-year eligibility period is based on the dialysis facility's as-filed or final settled cost reports for 12 consecutive months. For hospital-based dialysis facilities, when a hospital has multiple locations and treatment counts are aggregated in the hospital's cost report, its MAC may consider other supporting documentation, which may include individual facility treatment counts rather than the hospital's cost report alone.
- 10 Specifically, a facility attests that it was low volume for the first two eligibility years and that it will be for the third eligibility year. In most cases, the MAC will not have received the third eligibility year's cost report and will rely on the attestation to allow the application of the adjustment.
- 11 Facilities are eligible for the LVPA if the change in ownership resulted in a change of facility type. According to CMS, common ownership means the same individual, individuals, entity, or entities directly or indirectly own 5 percent or more of each dialysis facility.
- 12 Across all facilities in 2017, total treatment volume averaged roughly 11,000 treatments.
- 13 The cost analysis uses 2017 cost reports submitted by freestanding dialysis facilities to CMS. This analysis defines total cost as all services in the PPS payment bundle and adjusts total cost per treatment to remove differences in the cost of labor. Cost report data are unaudited, meaning that they do not reflect the audit that PAMA mandated. In the final rule for the 2019 ESRD PPS, the agency said that the audit process is complete and the audit staff are reviewing the findings (Centers for Medicare & Medicaid Services 2018). Historically, facilities' cost reports have included costs that Medicare does not allow.
- 14 Urban areas are metropolitan statistical areas (MSAs) or a metropolitan division (which is a smaller group of counties or equivalent entities defined within an MSA containing a single core with a population of at least 2.5 million).
- 15 We found that more than 100 facilities that were eligible did not receive the LVPA in 2017 (see text box on qualification for the LVPA, p. 191).
- 16 We exclude hospital-based dialysis facilities because there is no guarantee of consistency in the methods used to allocate hospital costs to dialysis departments and to dialysis cost

categories. CMS has said that expense data for hospital-based cost reports reflect the allocation of overhead of the entire institution and that the expenses of each hospital-based component may be skewed (Centers for Medicare & Medicaid Services 2014).

17 CMS applied a natural log transformation to average treatment costs and used an outer fence methodology to identify average costs that are unusually high or low for exclusion from the regression.

18 The control variables identify facility type as hospital based or freestanding, facility size (4,000 treatments or fewer and ineligible for the low-volume adjustment, 4,000 to 4,999 treatments, 5,000 to 9,999 treatments, and 10,000 or more treatments), ownership type (independent, large dialysis organization, regional chain, unknown), calendar year of data (to combine data from multiple years), and the portion of treatments that included self-dialysis training.

19 Our estimate of the LVPA adjustment is higher than ESRD PPS factor in part because the ESRD PPS factor is adjusted by the ratio of low volume to other volume category factors, whereas our estimate incorporates other volume category factors into the base rate.

20 Instead, the share of costs explained by the intercept and the control variables could be effectively combined into the ESRD base rate (which is the same for all facilities) such that all costs are accounted for in estimating the ESRD PPS base rate and adjustment factors.

21 Similarly, CMS found that facilities associated with large and regional dialysis organizations had higher average dialysis cost per treatment compared with independent freestanding dialysis facilities (Centers for Medicare & Medicaid Services 2009).

References

- Centers for Medicare & Medicaid Services, Department of Health and Human Services. 2019. Medicare program; end-stage renal disease prospective payment system, payment for renal dialysis services furnished to individuals with acute kidney injury, end-stage renal disease quality incentive program, durable medical equipment, prosthetics, orthotics and supplies (DMEPOS) competitive bidding program (CBP) amendments, standard elements for a DMEPOS order, and master list of DMEPOS items potentially subject to a face-to-face encounter and written order prior to delivery and/or prior authorization requirements. Final rule. *Federal Register* 84, no. 217 (November 8): 60648–60809.
- Centers for Medicare & Medicaid Services, Department of Health and Human Services. 2018. Medicare program; end-stage renal disease prospective payment system, payment for renal dialysis services furnished to individuals with acute kidney injury, end-stage renal disease quality incentive program, durable medical equipment, prosthetics, orthotics and supplies (DMEPOS) competitive bidding program (CBP) and fee schedule amounts, and technical amendments to correct existing regulations related to the CBP for certain DMEPOS. Final rule. *Federal Register* 83, no. 220 (November 14): 56922–57073.
- Centers for Medicare & Medicaid Services, Department of Health and Human Services. 2015. Medicare program; end-stage renal disease prospective payment system, and quality incentive program. Final rule. *Federal Register* 80, no. 215 (November 16): 68967–69077.
- Centers for Medicare & Medicaid Services, Department of Health and Human Services. 2014. Medicare program; end-stage renal disease prospective payment system, quality incentive program, and durable medical equipment, prosthetics, orthotics, and supplies. Final rule. *Federal Register* 79, no. 215 (November 6): 66120–66265.
- Centers for Medicare & Medicaid Services, Department of Health and Human Services. 2009. Medicare programs; end-stage renal disease prospective payment system. Proposed rule. *Federal Register* 74, no. 187 (September 29): 49922–50102.
- DaVita. 2019. Annual report pursuant to Section 13 or 15(d) of the Securities Exchange Act of 1934 for the fiscal year ended December 31, 2018.
- Government Accountability Office. 2013. *End-stage renal disease: CMS should improve design and strengthen monitoring of low-volume adjustment*. Report 13–287. Washington, DC: GAO.
- Medicare Payment Advisory Commission. 2019a. Comment letter on a proposed rule on the Medicare program’s end-stage renal disease prospective payment system and quality incentive program. Proposed rule. September 20.
- Medicare Payment Advisory Commission. 2019b. Report to the Congress: Medicare payment policy. Washington, DC: MedPAC.
- Medicare Payment Advisory Commission. 2018. Comment letter to CMS on the end-stage renal disease prospective payment system and Quality Incentive Program proposed rule, August 31.
- Medicare Payment Advisory Commission. 2017. *Report to the Congress: Medicare payment policy*. Washington, DC: MedPAC.
- Medicare Payment Advisory Commission. 2015. Comment letter to CMS on the ESRD prospective payment system and the ESRD Quality Incentive Program, August 6.
- Medicare Payment Advisory Commission. 2014. *Report to the Congress: Medicare payment policy*. Washington, DC: MedPAC.
- Medicare Payment Advisory Commission. 2012. *Report to the Congress: Medicare and the health care delivery system*. Washington, DC: MedPAC.

A P P E N D I X

A

**Commissioners' voting
on recommendations**



Commissioners' voting on recommendations

In the Medicare, Medicaid, and SCHIP Benefits Improvement and Protection Act of 2000, the Congress required MedPAC to call for individual Commissioner votes on each recommendation and to document the voting record in its report. The information below satisfies that mandate.

Chapter 1: Realizing the promise of value-based payment in Medicare: An agenda for change

No recommendations

Chapter 2: Challenges in maintaining and increasing savings from accountable care organizations

The Secretary should use the same set of national provider identifiers to compute both performance-year and baseline assignment for accountable care organizations in the Medicare Shared Savings Program.

Yes: Buto, Casalino, Crosson, DeBusk, DeSalvo, M. Ginsburg, P. Ginsburg, Grabowski, Jaffery, Navathe, Perlin, Pyenson, Ryu, Safran, Thompson, Wang

Absent: Thomas

Chapter 3: Replacing the Medicare Advantage quality bonus program

The Congress should replace the current Medicare Advantage (MA) quality bonus program with a new MA value incentive program that:

- scores a small set of population-based measures;
- evaluates quality at the local market level;
- uses a peer-grouping mechanism to account for differences in enrollees' social risk factors;

- establishes a system for distributing rewards with no “cliff” effects; and
- distributes plan-financed rewards and penalties at a local market level.

Yes: Buto, Casalino, Crosson, DeBusk, DeSalvo, M. Ginsburg, P. Ginsburg, Grabowski, Jaffery, Navathe, Perlin, Pyenson, Ryu, Safran, Thomas, Thompson, Wang

Chapter 4: Mandated report: Impact of changes in the 21st Century Cures Act to risk adjustment for Medicare Advantage enrollees

No recommendations

Chapter 5: Realigning incentives in Medicare Part D

5-1 The Congress should make the following changes to the Part D prescription drug benefit:

- Below the out-of-pocket threshold:
 - Eliminate the initial coverage limit.
 - Eliminate the coverage-gap discount program.
- Above the out-of-pocket threshold:
 - Eliminate enrollee cost sharing.
 - Transition Medicare’s reinsurance subsidy from 80 percent to 20 percent.
 - Require pharmaceutical manufacturers to provide a discount equal to no less than 30 percent of the negotiated price for brand drugs, biologics, biosimilars, and high-cost generic drugs.

Yes: Buto, Casalino, Crosson, DeBusk, DeSalvo, M. Ginsburg, P. Ginsburg, Grabowski, Jaffery, Navathe, Perlin, Pyenson, Ryu, Safran, Thomas, Thompson

Abstain: Wang

5-2 Concurrent with our recommended changes to the benefit design, the Congress should:

- Establish a higher copayment amount under the low-income subsidy for nonpreferred and nonformulary drugs.
- Give plan sponsors greater flexibility to manage the use of drugs in the protected classes.
- Modify the program’s risk corridors to reduce plans’ aggregate risk during the transition to the new benefit structure.

Yes: Buto, Casalino, Crosson, DeBusk, DeSalvo, M. Ginsburg, P. Ginsburg, Grabowski, Jaffery, Navathe, Perlin, Pyenson, Ryu, Safran, Thomas, Thompson

Abstain: Wang

5-3 Concurrent with our recommended changes to the benefit design, the Secretary should:

- Allow plans to establish preferred and nonpreferred tiers for specialty-tier drugs.
- Recalibrate Part D’s risk adjusters to reflect the higher benefit liability that plans bear under the new benefit structure.

Yes: Buto, Casalino, Crosson, DeBusk, DeSalvo, M. Ginsburg, P. Ginsburg, Grabowski, Jaffery, Navathe, Perlin, Pyenson, Ryu, Safran, Thomas, Thompson

Abstain: Wang

Chapter 6: Separately payable drugs in the hospital outpatient prospective payment system

No recommendations

Chapter 7: Improving Medicare’s end-stage renal disease prospective payment system

7-1 The Congress should direct the Secretary to eliminate the end-stage renal disease prospective payment system’s transitional drug add-on payment adjustment for new drugs in an existing end-stage renal disease functional category.

Yes: Buto, Casalino, Crosson, DeBusk, DeSalvo, M. Ginsburg, P. Ginsburg, Grabowski, Jaffery, Navathe, Perlin, Pyenson, Ryu, Safran, Thomas, Thompson, Wang

7-2 The Secretary should replace the current low-volume and rural payment adjustments in the end-stage renal disease prospective payment system with a single adjustment for dialysis facilities that are isolated and consistently have low volume, where low-volume criteria are empirically derived.

Yes: Buto, Casalino, Crosson, DeBusk, DeSalvo, M. Ginsburg, P. Ginsburg, Grabowski, Jaffery, Navathe, Perlin, Pyenson, Ryu, Safran, Thomas, Thompson, Wang

Acronyms

Acronyms

3M HIS	3M Health Information Systems	GAO	Government Accountability Office
AAGR	average annual growth rate	GDR	generic dispensing rate
A-APM	advanced alternative payment model	HCC	hierarchical condition category
ACA	Affordable Care Act of 2010	HCPCS	Healthcare Common Procedure Coding System
ACO	accountable care organization	HEDIS®	Healthcare Effectiveness Data and Information Set®
ACS	ambulatory care sensitive	HMO	health maintenance organization
AMI	acute myocardial infarction	HOS	Health Outcomes Survey
APC	ambulatory payment classification	HVIP	hospital value incentive program
APG	ambulatory patient group	ICL	initial coverage limit
AQC	Alternative Quality Contract	IPPS	inpatient prospective payment system
ASP	average sales price	I-SNP	institutional special needs plan
AWV	annual wellness visit	LDO	large dialysis organization
B	billion	LICS	low-income cost-sharing subsidy
BBA	Bipartisan Budget Act	LIS	low-income [drug] subsidy
BCBS	Blue Cross Blue Shield	LTI	long-term institutionalized
BCS	breast cancer screening	LVI	low volume and isolated
CAHPS®	Consumer Assessment of Healthcare Providers and Systems®	LVPA	low-volume payment adjustment
CHF	congestive heart failure	M	million
CMMI	Center for Medicare & Medicaid Innovation	MA	Medicare Advantage
CMS	Centers for Medicare & Medicaid Services	MAC	Medicare administrative contractor
CMS-HCC	CMS hierarchical condition category	MA-PD	Medicare Advantage–Prescription Drug [plan]
CNS	central nervous system	MA-VIP	Medicare Advantage value incentive program
COPD	chronic obstructive pulmonary disease	MedPAC	Medicare Payment Advisory Commission
C-SNP	chronic condition special needs plan	MedPAR	Medicare Provider Analysis and Review
CV	coefficient of variation	MIPPA	Medicare Improvements for Patients and Providers Act of 2008
CY	calendar year	MMA	Medicare Prescription Drug, Improvement, and Modernization Act of 2003
DMEPOS	durable medical equipment, prosthetic devices, prosthetics, orthotics, and supplies	MMP	Medicare–Medicaid Plan
DRG	diagnosis related group	MSA	metropolitan statistical area
D-SNP	dual-eligible special needs plan	MSSP	Medicare Shared Savings Program
EAPG	Enhanced Ambulatory Patient Group	N/A	not applicable
ED	emergency department	NDA	new drug application
EGWP	employer group waiver plan	NextGen	Next Generation
EHR	electronic health record	NPI	national provider identifier
ePA	electronic prior authorization	NTAP	new technology add-on payment
ESA	erythropoiesis-stimulating agent	OOP	out of pocket
ESRD	end-stage renal disease	OPPS	outpatient prospective payment system
F&B	formulary and benefit	PACE	Program of All-Inclusive Care for the Elderly
FB	full benefit	PAMA	Protecting Access to Medicare Act of 2014
FDA	Food and Drug Administration	PB	partial benefit
FFS	fee-for-service		

PBM	pharmacy benefit manager	RTBT	real-time benefit tool
PCP	primary care physician	RxHCC	prescription drug hierarchical condition category
PDP	prescription drug plan	SCI	substantial clinical improvement
POS	point of sale	SCOD	specified covered outpatient drug
PPO	preferred provider organization	SNP	special needs plan
PPS	prospective payment system	SPNPT	separately payable non-pass-through
PR	predictive ratio	SSA	Social Security Act
QBP	quality bonus program	TDAPA	transitional drug add-on payment adjustment
QIP	Quality Incentive Program	TIN	taxpayer identification number
R&D	research and development	V	version
RDS	retiree drug subsidy	VBP	value-based payment

More about MedPAC

Commission members

Francis J. Crosson, M.D., chairman

Los Altos, CA

Paul B. Ginsburg, Ph.D., vice chairman

Brookings Institution

Washington, DC

Term expires April 2020

Kathy Buto, M.P.A.

Arlington, VA

Francis J. Crosson, M.D.

David Grabowski, Ph.D.

Harvard Medical School

Boston, MA

Dana Gelb Safran, Sc.D.

Haven

Boston, MA

Warner Thomas, M.B.A.

Ochsner Health System

New Orleans, LA

Term expires April 2021

Karen DeSalvo, M.D., M.P.H., M.Sc.

Google Health

Palo Alto, CA

Marjorie Ginsburg, B.S.N., M.P.H.

Sacramento, CA

Jonathan Jaffery, M.D., M.S., M.M.M.

University of Wisconsin School of
Medicine and Public Health

Madison, WI

Jonathan Perlin, M.D., Ph.D., M.S.H.A.

HCA Healthcare

Nashville, TN

Jaewon Ryu, M.D., J.D.

Geisinger Health System

Danville, PA

Susan Thompson, M.S., B.S.N.

UnityPoint Health

West Des Moines, IA

Term expires April 2022

Lawrence Casalino, M.D., Ph.D.

Weill Cornell Department of Healthcare

Policy and Research

New York, NY

Brian DeBusk, Ph.D.

DeRoyal Industries

Powell, TN

Paul B. Ginsburg, Ph.D.

Amol Navathe, M.D., Ph.D.

University of Pennsylvania School of
Medicine

Philadelphia, PA

Bruce Pyenson, F.S.A., M.A.A.A.

Milliman Inc.

New York, NY

Pat Wang, J.D.

Healthfirst

New York, NY

Commissioners' biographies

Kathy Buto, M.P.A., is an independent consultant and an expert in U.S. and international health policy. She serves on the Healthcare Leadership Council of the Healthcare Financial Management Association and as a venture adviser to Incube Labs LLC. She also serves on the board of the Arlington Free Clinic and as a member of Women of Impact, a women's health care leadership group. Her previous positions include vice president of global health policy at Johnson & Johnson, senior health adviser at the Congressional Budget Office, deputy director of the Center for Health Plans and Providers at the Health Care Financing Administration (now the Centers for Medicare & Medicaid Services), and deputy executive secretary for health at the Department of Health and Human Services. Ms. Buto received her master's in public administration from Harvard University.

Lawrence Casalino, M.D., Ph.D., is the Livingston Professor of Public Health and chief of the division of Healthcare Policy and Economics in the Weill Cornell Department of Healthcare Policy and Research in New York, NY. His research primarily focuses on physicians, the organization of the health care delivery system, and payment and regulatory policies that impact physicians and the delivery system as well as patients. Among other appointments, Dr. Casalino served as a senior advisor to the director of the Agency for Healthcare Research and Quality. He currently serves on the Congressional Budget Office's Panel of Health Advisors. Dr. Casalino was a primary care physician in private practice for 20 years. He received his M.D. from the University of California, San Francisco, and his Ph.D. in health services research from the University of California, Berkeley.

Francis J. Crosson, M.D., spent 35 years as a physician and physician executive at Kaiser Permanente. In 1997, he founded and then for 10 years led the Permanente Federation LLC, the national umbrella organization for the physician half of Kaiser Permanente. Later he served as senior fellow at the Kaiser Permanente Institute for Health Policy and director of public policy for The Permanente Medical Group. From July 2012 through October 2014, he was group vice president of the American Medical Association in Chicago, IL, where he oversaw work related to physician practice satisfaction, efficiency, and sustainability. He previously served on MedPAC

from 2004 to 2010, including as vice chair from 2009 to 2010. Dr. Crosson received his medical degree from the Georgetown University School of Medicine.

Brian DeBusk, Ph.D., is chief executive officer of DeRoyal Industries in Powell, TN, which operates in the surgical, orthopedic, wound care, and health care information technology markets. He also serves as vice chairman of the Board of Trustees of Lincoln Memorial University in rural Tennessee, which includes graduate medical education programs for physicians, physician assistants, nurse practitioners, and nurses. Dr. DeBusk's prior employment includes General Electric, Inobis, and Pace Energy Systems. He has served on the faculty of both the University of Tennessee and Lincoln Memorial University, teaching classes in information technology and business strategy. Dr. DeBusk holds a Ph.D. in electrical engineering from Vanderbilt University and a master of business administration from Emory University.

Karen DeSalvo, M.D., M.P.H., M.Sc., is chief health officer at Google Health. She also is an adjunct professor of medicine and population health at the Dell Medical School at the University of Texas at Austin and co-convenor of the National Alliance to Impact the Social Determinants of Health. She is also president of the Society of General Internal Medicine and serves on the board of directors for Welltower. Before joining the University of Texas, Dr. DeSalvo was dually appointed as the acting assistant secretary for health and the national coordinator for health information technology at the Department of Health and Human Services. She has also served as the New Orleans health commissioner and as vice dean for community affairs and health policy at Tulane School of Medicine. Dr. DeSalvo received her medical and public health degrees from Tulane University School of Medicine, where she also completed her residency and fellowship in internal medicine. She has a master's degree in clinical epidemiology from the Harvard School of Public Health.

Marjorie Ginsburg, B.S.N., M.P.H., is the founding executive director of the Center for Healthcare Decisions Inc., which she ran from 1994 to mid-2016. In that role, she was responsible for the design, implementation, and evaluation of projects and programs that fostered civic engagement around health policy issues that affected

individuals and society at large. Among the policy issues Ms. Ginsburg studied were end-of-life care, health plan benefits design, and strategies to reduce overuse of unnecessary medical care. Ms. Ginsburg currently volunteers as a Medicare counselor with California's State Health Insurance Assistance Program (called the Health Insurance Counseling and Advocacy Program) in Sacramento, CA.

Paul B. Ginsburg, Ph.D., is the Leonard Schaeffer Chair in Health Policy Studies at the Brookings Institution in Washington, DC, and professor of health policy at the University of Southern California, where he is affiliated with the USC Schaeffer Center for Health Policy and Economics. He directs the USC-Brookings Schaeffer Initiative for Health Policy. Prior positions include founder and president of the Center for Studying Health System Change, founding executive director of the Physician Payment Review Commission, senior economist at RAND, and deputy assistant director at the Congressional Budget Office. Dr. Ginsburg earned his doctorate in economics from Harvard University.

David Grabowski, Ph.D., is a professor in the Department of Health Care Policy at Harvard Medical School in Boston, MA. His research primarily focuses on the economics of aging, with an emphasis on post-acute and long-term care financing, organization, and delivery of services. Dr. Grabowski served as a member of several CMS technical expert panels related to home health and skilled nursing facility payment and quality. He serves on the editorial board of several journals, including the *American Journal of Health Economics*. Dr. Grabowski received his Ph.D. in public policy from the Irving B. Harris School of Public Policy at the University of Chicago.

Jonathan Jaffery, M.D., M.S., M.M.M., is a professor of medicine at the University of Wisconsin School of Medicine and Public Health. Dr. Jaffery serves as senior vice president/chief population health officer at UW Health and as president of UW Health ACO Inc., where he is responsible for the overall development, coordination, and implementation of the population health strategy. A board-certified nephrologist, Dr. Jaffery holds a B.A. in Russian literature from the University of Michigan and an M.D. from The Ohio State University College of Medicine. He completed an internal medicine residency and nephrology fellowship at the University of Vermont. A former Robert Wood Johnson Foundation Health Policy

Fellow and chief medical officer for the Wisconsin State Medicaid program, Dr. Jaffery has graduate degrees from the University of Wisconsin School of Medicine and Public Health and the University of Southern California Marshall School of Business.

Amol Navathe, M.D., Ph.D., is codirector of the Healthcare Transformation Institute and associate director of the Center for Health Incentives and Behavioral Economics in the Department of Medical Ethics and Health Policy at the University of Pennsylvania's School of Medicine. He is also an assistant professor at Penn and staff physician at the Corporal Michael J. Crescenz VA Medical Center in Philadelphia, PA. Dr. Navathe's research group designs, tests, and evaluates payment models for national insurers and state Blue Cross Blue Shield plans. He leads the American Hospital Association's national bundled payment collaborative to disseminate evidence-based best practices. Among other appointments, Dr. Navathe was formerly a managing director, Healthcare Value Transformation, at Navigant. Dr. Navathe received his M.D. from the University of Pennsylvania and his Ph.D. in health care management and economics from the Wharton School at the University of Pennsylvania.

Jonathan Perlin, M.D., Ph.D., M.S.H.A., is the president of clinical services and chief medical officer of HCA Healthcare in Nashville, TN. In that role, he has leadership responsibility for clinical services and improving performance at HCA's hospitals and other sites of service. Before joining HCA, Dr. Perlin was Under Secretary for Health in the U.S. Department of Veterans Affairs. Dr. Perlin is a member of the National Academy of Medicine and has faculty appointments at Vanderbilt University and Virginia Commonwealth University. Dr. Perlin received his Ph.D. in pharmacology and his medical degree from the Medical College of Virginia at Virginia Commonwealth University, where he also completed his residency training in internal medicine.

Bruce Pyenson, F.S.A., M.A.A.A., is principal and consulting actuary at Milliman Inc. in New York, NY. His work has focused on diverse aspects of health care and insurance, including recent work related to alternative payment models for accountable care organizations, such as shared savings, as well as financial modeling of therapeutic interventions. He has co-authored publications on such topics as the cost-effectiveness of lung cancer screening, pandemic influenza, and site-of-service cost differences for chemotherapy. Mr. Pyenson is a fellow of

the Society of Actuaries and a member of the American Academy of Actuaries. He is adjunct clinical associate professor of New York University's College of Global Public Health.

Jaewon Ryu, M.D., J.D., is the president and CEO for Geisinger, an integrated health care system headquartered in Danville, PA, that comprises hospitals, employed providers, a health plan, a medical school, and research and innovation centers. He previously served as president of integrated care delivery at Humana and held leadership roles at the University of Illinois Hospital & Health Sciences System and at Kaiser Permanente. Dr. Ryu received his undergraduate education at Yale University and his medical and law degrees from the University of Chicago, after which he completed his residency training in emergency medicine at Harbor-UCLA Medical Center.

Dana Gelb Safran, Sc.D., is head of measurement for Haven, the health care venture formed by Amazon, Berkshire Hathaway, and JPMorgan Chase. In that role, she is part of the organization's core leadership team and is responsible for applying data, analytics, and measurement to optimize the venture's success. Dr. Safran was previously chief performance measurement and improvement officer at Blue Cross Blue Shield of Massachusetts (BCBSMA). As an architect of the BCBSMA Alternative Quality Contract and the leader responsible for its unique use of behavioral economics and payer-provider collaboration to reduce cost while improving quality, Dr. Safran is widely recognized as having contributed to the national push toward value-based payment. Before joining BCBSMA, she led a research institute at Tufts University School of Medicine dedicated to developing patient-reported measures of health and health care quality. She remains on the faculty at Tufts and serves on a number of state and national advisory bodies related to health care quality and affordability. She earned her master's and doctor of science degrees from the Harvard School of Public Health.

Warner Thomas, M.B.A., is president and CEO of the Ochsner Health System in New Orleans, LA. He oversees a network of 40 owned, managed, and affiliated hospitals and specialty hospitals, more than 100 health and urgent care centers, and more than 4,500 employed and affiliated physicians. Ochsner is the only Louisiana hospital recognized by U.S. News & World Report as a "Best Hospital" across three specialty categories caring for patients from all 50 states and more than 60 countries

worldwide each year. The Ochsner Health System operates one of the largest accredited non-university-based graduate medical education programs in the United States. It is also one of the largest Medicare risk contractors in the region and offers an accountable care organization for Medicare. Mr. Thomas's prior positions include chief operating officer of Ochsner Health System, vice president of managed care and network development at the Southern New Hampshire Medical Center, and senior auditor and consultant at Ernst & Young. He received his master of business administration from Boston University Graduate School of Management.

Susan Thompson, M.S., B.S.N., is interim president and chief executive officer of UnityPoint Health, an integrated delivery system serving Iowa, central and western Illinois, and central Wisconsin. She is also the chief executive officer of UnityPoint Health Accountable Care LC, an Iowa limited liability company that brings together a diverse group of health care providers including hospitals, employed and independent physicians, and other providers, as well as other health initiatives. Previously, she was senior vice president of integration and optimization for UnityPoint and was president and chief executive officer of UnityPoint Health-Fort Dodge, which serves a predominantly rural and aging population and includes a sole community hospital, a primary care and multispecialty physician group, management contracts with five critical access hospitals throughout the region, and a Pioneer Accountable Care Organization. She also served in successive clinical and management positions at Trinity Regional Medical Center, as intensive care staff nurse, director of quality systems, assistant director of patient-focused care, chief information officer, chief operating officer, and chief executive officer. Ms. Thompson obtained her B.S. in nursing and her M.S. in health services management from Clarkson College in Omaha, NE.

Pat Wang, J.D., is president and chief executive officer of Healthfirst in New York, NY. Healthfirst is a not-for-profit provider-sponsored health plan that serves Medicare enrollees, including those who are eligible for low-income subsidies and those who are dually eligible for Medicare and Medicaid. Healthfirst incorporates a value-based payment model that aligns incentives with hospital and physician partners. Ms. Wang previously served as senior vice president of finance and managed care for the Greater New York Hospital Association. She received her law degree cum laude from the New York University School of Law.

Commission staff

James E. Mathews, Ph.D.

Executive director

Dana K. Kelley, M.P.A.

Deputy director

Analytic staff

Alison Binkowski, M.P.H, M.I.A.

Rachel Burton, M.P.P.

Carol Carter, Ph.D.

Evan Christman, M.P.Aff.

Geoffrey Gerhardt, M.P.P.

David V. Glass, M.S.

Scott Harrison, Ph.D.

Andy Johnson, Ph.D.

Kim Neuman, M.A.

Brian O'Donnell, M.P.P.

Nancy Ray, M.S.

Eric Rollins, M.P.P.

Luis Serna, M.S.

Rachel Schmidt, Ph.D.

Jeffrey Stensland, Ph.D.

Shinobu Suzuki, M.A.

Ledia Tabor, M.P.H.

Jamila Torain, Ph.D., M.P.H.

Ariel Winter, M.P.P.

Daniel Zabinski, Ph.D.

Research assistants

Sam Bickel-Barlow

Carolyn San Soucie

Assistant director

Stephanie Cameron, Sc.M.

Special assistant

Molly Morein

Chief financial officer

Mary Beth Spittel

Production manager

Tina Jennings, MTESL

Administrative staff

Wylene Carlyle

Timothy Gulley

Cynthia Wilson

